



**EQUESTRIAN  
CANADA  
ÉQUESTRE**

**SECTION C  
DRIVING AND PARA-DRIVING**

---

Rules of Equestrian Canada  
2025

# **CLEAN COPY EDITION**

This document contains the final text effective January 1, 2025.



# EQUESTRIAN CANADA RULEBOOK

The rules published herein are effective on January 1, 2025, and remain in effect for one year except as superseded by rule changes or clarifications published in subsequent editions of this section. Section C as printed herein is the official version of rules for driving competitions for 2025.

The Rule Book comprises the following sections:

- A General Regulations
- B Breeds
- C Driving and Para-Driving
- D Eventing
- E Dressage and Para-Dressage
- F General Performance, Western, Equitation
- G Hunter, Jumper, Equitation and Hack
- J Endurance
- K Reining and Para-Reining
- L Vaulting

## **Section C: DRIVING AND PARA-DRIVING**

is part of the Rule Book of Equestrian Canada  
and is published by:

### **EQUESTRIAN CANADA**

c/o House of Sport  
2451 Riverside Drive

Ottawa, Ontario K1H 7X7

Tel: (613) 287-1515; Fax: (613) 248-3484  
1-866-282-8395

Email: [rules@equestrian.ca](mailto:rules@equestrian.ca)

Web site: [www.equestrian.ca](http://www.equestrian.ca)

# EQUESTRIAN CANADA RULE BOOK

## SECTION C DRIVING AND PARA-DRIVING

These Rules are to be used in conjunction with the General Regulations of Equestrian Canada.

### TABLE OF CONTENTS

The Equestrian Canada Rulebook.....	v
<b>PART ONE – GENERAL REGULATIONS.....</b>	<b>1</b>
Chapter 1 - Introduction and Definitions.....	1
Chapter 2 - Conduct and Cruelty.....	3
Chapter 3 - Safety and Emergencies.....	5
Chapter 4 - The Competitor.....	7
Chapter 5 - Grooms and Attendants.....	9
Chapter 6 - The Horse.....	9
Chapter 7 - The Harness.....	11
Chapter 8 - The Vehicle.....	12
Appendices.....	13
Appendix 1-A - Event Summary Table.....	13
Appendix 1-B – Safety Checklist.....	14
Appendix 1-C – Sample Emergency Preparedness Plan.....	15
<b>PART TWO - PLEASURE DRIVING COMPETITIONS.....</b>	<b>16</b>
Chapter 1 - General Rules.....	16
Chapter 2 - Clarification of Gaits.....	21
Chapter 3 - Class Divisions.....	23
Chapter 4 – Class Specifications.....	25
Chapter 5 – Class Specifications: Combined Classes.....	28
Chapter 6 – Class Specifications: Specialty Classes.....	29
Chapter 7 – Class Specifications: Pleasure Obstacle Driving.....	31
Chapter 8 – Class Specifications for Pleasure Drives.....	43
Chapter 9 – Putting-To Classes.....	48
Chapter 10 – Rules for Coaching Competitions.....	50
Chapter 11 – Continuous Driving.....	51
Appendices.....	54
Appendix 2-A – Turnout and Appointments.....	54
Appendix 2-B – Pleasure Driving Officials Requirements.....	63
<b>PART THREE – DRAFT HORSE DRIVING COMPETITIONS.....</b>	<b>64</b>
Chapter 1 – Draft Equine Rules.....	64
Appendices.....	67
Appendix 3-A – Sample Obstacle for Draft Horse Competitions.....	67
<b>PART FOUR – RECREATIONAL DRIVING COMPETITIONS.....</b>	<b>68</b>
Chapter 1 - TREC.....	68

Chapter 2 – Country Heritage .....	72
Chapter 3 – Sleigh Rallies.....	75
<b>PART FIVE –DRIVEN DRESSAGE COMPETITIONS .....</b>	<b>76</b>
Chapter 1 – Governing Regulations .....	76
Chapter 2 – Movements .....	76
Chapter 3 – Specifications .....	80
Chapter 4 – Driven Dressage Tests .....	81
Chapter 5 – Scoring.....	84
Chapter 6 – Dressage Officials and Management .....	86
Chapter 7 – Welfare of the Horse.....	87
Appendices.....	90
Appendix 5-A – Abbreviations .....	90
Appendix 5-B – Large and Small Arenas.....	91
Appendix 5-C – List of Dressage Tests.....	92
Appendix 5-D – Dressage Test Scoring .....	93
Appendix 5-E - Freestyle Dressage Score Form .....	94
<b>PART SIX – LICENSED OFFICIALS .....</b>	<b>95</b>
Chapter 1 – Competition Officials .....	95
Chapter 2 –Advisory Process .....	105
Chapter 3 – Non-licenSed Competition Personnel.....	107
<b>PART SEVEN – PARA-DRIVING.....</b>	<b>111</b>
Appendix 7-A - Definitions and Interpretation .....	122
Appendix 7-B - FEI Dressage Test No. 4 PE.....	123
Appendix 7-C - Addendum for Para-Equestrian Driving.....	125
<b>PART EIGHT - RESERVED FOR FUTURE USE.....</b>	<b>129</b>
<b>PART NINE - RULES FOR COMBINED DRIVING COMPETITIONS..</b>	<b>130</b>
Chapter 1 – General .....	131
Chapter 2 – Structure of Competitions.....	134
Chapter 3 Classification.....	136
Chapter 4 – Eligibility (Age of Athletes – Starting Possibilities).....	138
Chapter 5 – Athletes.....	138
Chapter 6 – Horses .....	140
Chapter 7 – Carriages and Harness .....	145
Chapter 8 – Conditions for Participation.....	152
Chapter 9 Substitutions .....	156
Chapter 10 – Declaration of Starters – Order of Starting .....	157
Chapter 11 – Driven Dressage .....	157
Chapter 12 Marathon.....	167
Chapter 13 – Cones.....	183
Chapter 14 Officials.....	197
FEI Annexes.....	204
FEI Annex 1 - Diagram of the Driven Dressage Arena.....	204
FEI Annex 2 - Cones: Closed Multiple Obstacles.....	207
FEI Annex 3 - Cones : Open Multiple Obstacles.....	213
FEI Annex 4 – Cones : The Bridge and the Water Obstacle .....	216
FEI Annex 5 - Cones : Alternate/Option Cones .....	217
FEI Annex 7 – Cone Specifications .....	219
FEI Annex 8 – Addendum for Para-Driving.....	220

FEI Annex 9 – Badge of Honour .....	224
FEI Annex 10 - Definitions .....	225
Appendices .....	226
Appendix 9-A – Driving Trials.....	226
Appendix 9-B - Arena Trials .....	228
Appendix 9-C – Driving Derby (Summer and Winter).....	231
Appendix 9-E – CDE Quick Reference Guide .....	238
Appendix 9-E – CDE Quick Reference Guide .....	240
Appendix 9-F – VSE Size-adjusted Arena Diagrams .....	243
Appendix 9-G – Arena Driven Dressage Test .....	245
Appendix 9-H – Arena Driven Dressage Test .....	247
<b>GLOSSARY .....</b>	<b>250</b>
<b>METRIC CONVERSION.....</b>	<b>266</b>
<b>INDEX.....</b>	<b>267</b>

# EQUESTRIAN CANADA

Equestrian Canada is the national governing body for equestrian sport in Canada, with a mandate to represent, promote and advance the sport in Canada, and to represent, promote advocate for and advance all related equine and equestrian interests, including recreation, industry and equine health and welfare.

## PATRON

Her Excellency the Right Honourable Mary Jeannie May Simon CC., CMM., COM.,  
OQ., CD., FRCGS., Governor General of Canada

## THE EQUESTRIAN CANADA RULEBOOK

Knowledge of the rules of any sport is required of each participant, and the competitor at an EC-sanctioned competition must accept this responsibility. Both a complete knowledge of and compliance with the rules are essential, and all participants must be fully cognizant of all rules as well as particular class specifications in the discipline/breed sport in which they compete.

It is not possible to provide for every conceivable eventuality in these rules. If there is no rule to deal specifically with a particular circumstance, or if the nearest interpretation of the pertinent rule would result in an obvious injustice, it is the duty of those responsible to make a decision based on common sense and fair play, thus reflecting as closely as possible the intention of the rules and regulations of Equestrian Canada.

### **Organization of the Rulebook**

The EC Rulebook is divided into multiple sections, grouped by disciplines and breed sports. Section A covers general regulations that apply to all EC members, competitors, officials, owners, equines, organizers and persons responsible unless superseded in other sections of the Rulebook.

### **Evergreen Rules Process**

The Equestrian Canada rulebooks are updated annually, effective January 1<sup>st</sup>. The official rulebook will be as published on the EC website and may be amended as follows.

### **Amendment of the Rules**

It is the right of every sport licence holder of Equestrian Canada to propose amendments to the rules, subject to the current policies, procedures and schedules. The deadline for Rule Change Suggestions (RCS) shall be May 31 each year in accordance with the procedures outlined on the EC Rule Change page. Suggestions will be reviewed by the appropriate discipline/breed sport EC committees who will consider all suggestions and put forward those they recommend as Rule Change Proposals (RCPs). RCPs will be posted on the EC website to allow for a 30-day review period. The EC committees will consider all comments and make any necessary revisions. Rule changes will be posted on the EC website in December to be effective January 1 the following year.

The amendment process will be strictly followed. Extraordinary rule amendments will be permitted only for FEI rule changes, safety, monetary, clarification, ethical and equine welfare reasons at the discretion of the National Rules Committee using the following protocol. Extraordinary rule amendments will be effective when



published by EC on its official website. FEI Rules, applicable to EC-sanctioned competitions, are effective upon publication by the FEI.

### **Extraordinary Amendment Process**

1. **Proposal** – An Extraordinary Rule Amendment (ERA) is composed by the EC discipline/breed committee, EC staff or National Rules Committee (NRC) with supporting rationale.
2. **Authorization** – The applicable discipline or breed committee must authorize each ERA, note it in their minutes and forward it to the NRC.
3. **Approval** – The NRC is responsible for confirming the ERA criteria (FEI rule change, safety, monetary, clarification, ethical or equine welfare) have been satisfied
4. **Posting** – EC will translate and post the amendment and show changes to both change visible and clean copy online Rulebooks. The amendments display the date of the NRC approval for consistency.
5. **Effective** – An ERA is effective when published on the EC website. The file reference shall retain the original approval date.

### **Interpretation of the Rules**

Please read all cross-references carefully and refer to the EC website for rule changes and/or clarifications. Should the English and French versions differ, the English version shall prevail. In the case of conflict between General Regulations and the regulations of the disciplines/breed sports, the discipline/breed sport rules will prevail.

# PART ONE – GENERAL REGULATIONS

## CHAPTER 1 - INTRODUCTION AND DEFINITIONS

### ARTICLE C101 INTRODUCTION

1. The rules of Equestrian Canada and published driven dressage tests of the FEI and other national federations are protected by copyright. (See Appendix 1-A, Event Summary Table).
2. SANCTIONING: Provincial and ECE sanctioning is required according to the Event Summary Table, Appendix 1-A.
3. OFFICIALS: ECE or ADS or USEF or Provincial (when possible) accredited driving officials (or individuals with approved Guest Cards) may officiate at Competitions according to the Event Summary Table, Appendix 1-A.
4. The purpose and spirit of Equestrian Canada Rules is to promote safety, welfare of the horse and fairness in competition at all EQUESTRIAN CANADA sanctioned events, shows, competitions and classes.
5. All participants at driving competitions are responsible for complete knowledge of and compliance with the rules of competition as set forth in this Rule Book. Drivers should also be fully cognizant of the class specifications.
6. In situations not covered specifically in the rulebook, or by direct interpretation of the rules, the spirit and intent of the rules must be upheld. Rule language supersedes information in Appendices.
7. For rules on specific types of competition, reference should be made to the following parts of this section of Equestrian Canada Rule Book:
  - Part One - General Regulations,
  - Part Two - Pleasure Driving Competitions;
  - Part Three – Draft Horse Driving Competitions;
  - Part Four – Recreation;
  - Part Five - Driven Dressage Competitions;
  - Part Nine – Combined Driving Competitions.The Rules of Equestrian Canada, Section A, General Regulations may be superseded by discipline rules for specific classes or competitions.
8. All competitors who are Canadian residents at Equestrian Canada-sanctioned competitions must be a member of their participating Provincial or Territorial Sport Organization (PTSO) and hold a valid Equestrian Canada Sport Licence for the classes entered, and pay applicable drug testing fees. EC membership/Sport Licence requirements may be waived for foreign nationals who are members in good standing of their national driving organization. Foreign nationals must be able to provide proof of public liability and property damage (PL&PD) insurance.
9. At EQUESTRIAN CANADA sanctioned Competitions, EC Stewards are not required when duties outlined in Article A1317.1-3 are performed by the Technical Delegate (or Judge if TD is not required).
10. Course Designers are required for all championship events or shows and competitions with Advanced Division Marathon classes (except Driving Trials); and are recommended for all Combined Driving Events and Pleasure Drives and cross-country classes.
11. VARIANCES: Any variances from the applicable rules must be approved by the TD (or judge if TD is not required). Variances must be published in the Prize List, or  
*2025 Rules of Equestrian Canada, Section C*

provided to each competitor prior to the competition, and sent to the sanctioning body (PTSO or ECE).

12. Disabilities - Prior to the arrival at the event location, competitors are encouraged to advise management of any specific accommodations which may not be accounted for in these rules. Management is encouraged to accommodate these requests wherever possible and to advise the competitor accordingly. These competitors are expected to provide their own equipment and personal support staff necessary to participate and compete.
13. The full use of modern therapeutic measures for the improvement and protection of the health of the horse is permitted unless those drugs and medications permitted, restricted or forbidden by Equestrian Canada policy or rules. See Section A, Chapter 10 – Equine Medication Control and Appendix A-1 – Policy on Human Medications.

#### **ARTICLE C102 DEFINITION OF TERMS**

1. The term HORSE used herein refers to any of: horse, pony, mule, donkey or zebra.
2. The term ATHLETE, COMPETITOR, or DRIVER used herein refers to the person controlling the reins and whip and brake.
3. The term GROOM used herein refers to the person capable of assisting in the event of difficulty.
4. The term MANAGEMENT used herein refers to the person(s) responsible for organizing and running the competition.
5. The term ENTRY used herein refers to the combination of driver, horse, and vehicle competing in EC-sanctioned classes or competitions.
6. Junior and Adult competition participants, e.g. anyone who rides on a vehicle at any time at an event, are defined as follows:
  - a) The COMPETITION AGE of an individual will be the age reached during the current calendar year.
  - b) JUNIOR A - competition age 10 and below. Junior A drivers may not compete in any classes held outside a securely enclosed arena and must be accompanied at all times by a knowledgeable adult horseman, capable of rendering assistance in an emergency situation at all times. In classes requiring a header, an appropriately attired, capable individual must come from the rail so that the driver is at no time alone in the vehicle.
  - c) JUNIOR B - competition age 11, 12, 13 must be accompanied at all times by a knowledgeable adult horseman, capable of rendering assistance in an emergency situation at all times. In classes requiring a header, an appropriately attired, capable individual must come from the rail so that the driver is at no time alone in the vehicle.

**EXCEPTION:** Junior “B” drivers competing with a single Very Small Equine (VSE, defined in Articles C212, C930.4) turnout in a securely enclosed arena need not be accompanied by a knowledgeable adult horseman unless required by show management.
  - d) JUNIOR C - competition age 14, 15, 16, 17,18 competing with a single horse/pony/VSE turnout need not carry a groom/passenger at the discretion of their parent or legal guardian, unless required by class specifications.
  - e) ADULT - competition age 19 and over.
  - f) JUNIOR – unless otherwise defined: Competition age under 19

7. When the terms, “prohibited”, “not permitted”, “mandatory”, “must”, “obligatory” or “required” are used in these rules, any competitor who fails to comply **MUST BE ELIMINATED** or **DISQUALIFIED** by the judge, unless another penalty is stipulated.
8. When the term “shall” is used in these rules, and no penalty is prescribed, any competitor who fails to comply **MUST BE SEVERELY PENALIZED** by the judge.
9. When the term “should” is used in these rules, any competitor who fails to comply **SHALL BE PENALIZED AT THE JUDGE’S DISCRETION**.
10. “Headgear” refers to good condition; properly fitted, approved protective headgear\* which must be worn by all Juniors while on a vehicle or horse anytime and anywhere at the event location. See Article C928. Refer to Section A - General Regulations, Glossary – *Headgear Standards*.
11. The use of approved protective headgear and vests is strongly recommended for everyone participating in all forms of driving including: training, recreation and competition. Approved protective headgear and/or vests may be worn in all competitions without penalty. Whenever Equestrian Canada rules stipulate that “hat” or “cap” or “headgear” is required, approved protective headgear may be worn.
12. A salute is performed with reins in one hand, and does not require removal of approved protective headgear if worn (Article C110). There is no salute in Pleasure Driving (Article C245), except as directed in Driven Dressage tests (C519.3) and in Combined Driving, Cone. See Article C943.2.8. For Athletes with disabilities, see FEI Annex 8 – Compensating Aids.
13. Sunglasses may be worn during bright sunlight without penalty.
14. Event/Show is the combination of any activities covered by the EC Rulebook. The activities commence and conclude as defined by the organizer and published in the Prize List.
15. Competition is a judged activity or grouping of divisions/classes within an Event or Show.
16. Division is a group of classes separated in various ways, including but not limited to driver and/or horse experience, configuration, turnout, animal size, animal or driver gender, vehicle style, breed, etc.
17. Class is an individually judged activity by a grouping of entries at a competition.
18. "Hors Concours" - An entry designated as "Hors Concours" (HC) participates with the approval of the organizer. An HC entry is a non-competing entry, subject to all Section C rules, and is not eligible for awards, placings or points in any class or championship. For the purpose of class entry totals affecting the Maiden, Novice or Limit status of horses or drivers, HC entries do not count.
19. “Competitor” / “Athlete” – see also “Driver” in C102.2 above.

## **CHAPTER 2 - CONDUCT AND CRUELTY**

### **ARTICLE C103            CONDUCT**

1. All participants in an EC-sanctioned competition are obliged to conduct themselves in an orderly manner and in the best interest of Equestrian Canada. Management shall bar violators from further participation for the remainder of the competition and report the incident to Equestrian Canada for any further disciplinary action deemed necessary.

2. Acting or permitting another person to act in a manner contrary to these rules or in a manner deemed improper, unethical, dishonest, unsportsmanlike, or prejudicial to the best interests of Equestrian Canada, and/or detrimental to the well-being of any animal(s), or making a remark considered offensive or made with the intent to influence or cast aspersions on the character or integrity of the judge or any other person is considered not in the best interest of Equestrian Canada.
3. It is the policy of Equestrian Canada that gambling in any form, with respect to the performance of a competitor, is strictly prohibited.
4. At Pleasure Driving Shows and Driven Dressage Competitions: the Judge has the authority and responsibility to eliminate a competitor for unsafe practice or inappropriate behavior within the ring; Show Management elsewhere. The Technical Delegate has no authority to disqualify but can point out infractions to Management who should handle the issues. The Technical Delegate can file a charge or present a Warning Card to any individual who displays inappropriate behavior.
5. At Combined Driving Events, the roles of the Ground Jury and Technical Delegate are defined in Articles C987.3, C988.3.
6. Any member of the Jury or the Technical Delegate can file a charge or present a Warning Card to any individual who displays inappropriate behavior, improper conduct, unsafe practices or non-compliance with the rules of Equestrian Canada.
7. The issuance of a Warning Card is not meant to replace the filing of charges for willful and serious violation of Equestrian Canada rules, and shall not prevent further investigation of the matters pursuant to the “Disciplinary Review Process”
8. A driver may not show before a judge, and the judge may not judge anyone who has been instructed by that judge within a period of 30 days prior to the competition. **(Exception:** Article C103.9).
9. A judge may officiate over entries (competitors and/or animals) who attended group clinics at the competition if:
  - a) The clinic is open to all competitors and animals entered.
  - b) The clinic is advertised and available to all possible entrants
  - c) During the clinic the judge does not drive any animal that is entered in the competition.

#### **ARTICLE C104 CRUELTY**

1. Cruelty to or the abuse of any animal by any person at an approved competition is forbidden and an offender is subject to disqualification. Examples: leaving whip marks; fresh blood around mouth or result of whipping; excessive use of whip; striking the horse on the head or poll; excessive use of reins to the point of abuse.
2. Management shall bar violators from further participation for the remainder of the competition and report the incident to EQUESTRIAN CANADA for any further disciplinary action deemed in order.
3. All animals must be serviceably sound and must not show evidence of lameness, broken wind, physical distress or impairment of vision in both eyes. In the case of an appeal on this ground, the judge will have the animal in question examined by the official veterinarian or designee for a decision by the judge or jury which will be final.
4. Equestrian Canada neither encourages nor discourages dogs accompanying an entry. Unless allowed by the class rules, dogs are not allowed to run alongside, behind under or ride on the vehicle during competition. In no circumstances may a dog be tied or

in any way attached to the vehicle. (For Combined Driving see Article C943.2.12; for Pleasure Driving see Article C231).

5. Caged or tethered animals are not allowed as part of or along the path of an obstacle course.
6. Excessive pressing of exhausted horses or competing with equines in poor debilitated condition is unacceptable. Cruelty also means an action or omission that causes or is likely to cause pain or unnecessary discomfort to a horse including, but not limited to:
  - a) Excessive use of a whip or other instrument on any horse in a stall, runway, schooling area, competition ring or elsewhere at the event location, before, after or during any competition, by any person. Striking the horse's head (on the poll and forward of the poll) with the whip or other instrument shall be deemed excessive,
  - b) An unacceptably severe, badly fitting, broken or damaged bit;
  - c) Badly fitting or poorly constructed harness which might cause distress to the Horse,
  - d) Damage to a Carriage which might cause injury to the Horse.
  - e) Any other action or condition which, in the opinion of a judge, Technical Delegate or Veterinarian is causing or will cause distress to a horse.

### **CHAPTER 3 - SAFETY AND EMERGENCIES**

#### **ARTICLE C105 RESPONSIBILITY OF ATHLETES AND OFFICIALS**

1. All persons involved in the competition: drivers, passengers, grooms, competition officials, spectators, etc., should keep safety foremost in their minds. Having the horse under control at all times is a safeguard not only for a driver and his/her passengers, but for everyone involved in the sport.
2. All officials and management should constantly be on the lookout for unsafe actions by any participant or equine or unsafe equipment. Such unsafe actions or failure to correct unsafe equipment may result in elimination or disqualification. The judge must eliminate from a class or competition, or disqualify from an event, any entry with an unsafe vehicle, unruly horse(s) or driver clearly out of control.
3. In the case of an accident, the judge or management may require a safety inspection of the vehicle and/or harness involved before allowing further use at the event.
4. It is the responsibility of each driver to ensure that harness and vehicle are in good repair and structurally sound.
5. It is the responsibility of each driver to ensure that his/her horse or horses are physically fit to fulfill the tasks required of them.
6. The driver should always be the first person to enter the vehicle and the last to leave. Passengers must never be left on the vehicle while the driver is dismounted unless the passenger has taken control of the reins.
7. It is strongly recommended that no turnout should rely solely on a groom or other attendant standing on the ground to control the horse or horses, with the exception of hitching and/or unhitching. If a driver dismounts for any reason other than to make minor adjustments to harness, vehicle, or to unhitch, the reins should be given to a driver seated on the vehicle.
8. Drivers should strive to maintain a safe distance from other vehicles during the competition and in the warm-up and parking areas.

9. All rules of the road should be observed unless uniformed officials direct otherwise.
10. The Technical Delegate should inspect any marathon, cross country course or obstacle course at a time early enough to allow any changes or alterations to conform to the rules and directives for safety and drivability. The Technical Delegate must bear in mind that alterations to any course are only in order if the plan violates a specific rule or is clearly undriveable or unsafe.
11. Equestrian Canada rules mandate the use of approved protective headgear. See Articles C102.10 and A905.
12. For unsafe practices or inappropriate behavior, see Article C103.4-6.
13. If a Judge is of the opinion an animal is unsound, he must notify the Technical Delegate and Management as soon as possible. A decision is to be made whether or not the animal may continue in the Event.
14. Competitors are responsible for the actions of and inappropriate behavior by their families, employees and grooms while at the event location. Any violation of event regulations or management directives by the said family members, employees or grooms may invoke penalties and/or sanctions against these individuals. (Also see Article C108.3).

#### **ARTICLE C106 RESPONSIBILITY TOWARD THE HORSE**

Failure to comply with the following may incur elimination or disqualification.

1. Whenever being put to or taken out of a vehicle, a horse must wear a bridle with reins attached to the bit and passed through the saddle terrets.  
**Exceptions:**
  - a) Once a horse is fully harnessed to a vehicle, one rein at a time may be adjusted.
  - b) Horses in multiple hitches must have at least one rein attached to the bit while being harnessed to a vehicle.
2. The horse must never be left unattended while put to a vehicle.

#### **ARTICLE C107 EMERGENCIES**

1. An Emergency Preparedness Plan should be adopted prior to the each event for handling emergencies such as fire, accident and horse mortality. (See Article A508)
2. Plans should include the names and contacts for management, show office, officials, emergency services and an appointed coordinator. See Appendix 1-C for a sample basic plan
3. For the protection of everyone including spectators, medical assistance must be available on the grounds and ambulance service availability must be determined. Management should make the arrangements well in advance of the competition.
4. Medical assistance availability on the grounds may include any of the following:
  - a) Medical Doctor on hand
  - b) Professional emergency personnel.
  - c) Individuals with recognized and valid First Aid training who are not competing; these individuals may act in some other capacity at the competition providing this does not inhibit their availability to all areas of the competition grounds.
5. A competition must have a qualified veterinarian present or on call.

6. It is advisable that every sanctioned competition have provisions for a farrier as required by the level of competition or these rules.
7. A meeting for personal briefing for those involved in the Emergency Preparedness Plan must be held prior to the competition or event.
8. Emergency contacts and procedures must be prominently posted or distributed.

#### **ARTICLE C108 OPERATION OF MOTORIZED VEHICLES**

1. Only those with a valid driver's licence which allows them to operate a motorized vehicle in the jurisdiction in which they reside may operate a motorized vehicle of any kind (including, but not limited to, golf carts, motorcycles, scooters, or farm utility vehicles) at the event location. Minors who have a valid temporary licence or learner permit may operate motorized vehicles only when accompanied by an adult with a valid driver's licence.  
**Exception:** Wheelchairs and other mobility assistance devices for individuals with disabilities.
2. People on foot and/or horses have the right of way over all motorized vehicles at the event location except in an emergency situation.
3. The parent(s) or legal guardian(s) of a minor operating a motorized vehicle in violation of this rule is solely responsible for any damages, claims, losses or actions resulting from that operation. Violations of this rule will be cause for penalties and/or sanctions against the parent(s), guardian(s) and/or trainer(s) who are responsible for the child committing the offense.
4. Penalties may include exclusion of the child, parent(s), guardian(s) and/or trainer(s) from the event location for the remainder of the event.

### **CHAPTER 4 - THE COMPETITOR**

#### **ARTICLE C109 STYLE OF DRIVING**

1. The driver should be seated comfortably on the box so as to be relaxed and effective. Either the one or two handed method of driving is acceptable, unless stated otherwise for competition classes. Common to both methods the elbows and arms should be close to the body with an allowing, but steady hand enabling a consistent "feel" of the horse's mouth. Drivers should not be penalized or rewarded for using one style over another. (*See C223*).



## **ARTICLE C110 USE OF THE WHIP; PERFORMING A SALUTE**

1. An appropriate driving whip should be carried in hand at all times while the vehicle is in motion. The thong on the whip should be long enough to reach the shoulder of the farthest horse.
2. The whip salute should be performed as follows:
  - a) Drivers shall take the reins in the left hand and position the whip, held in the right hand with the handle in front of the face, to a vertical or a horizontal position.
  - b) Alternately, a gentleman shall place the whip and reins in his left hand and remove his hat with his right hand, letting his right arm drop loosely along his body. When wearing approved protective headgear, gentlemen shall perform the salute as described in (a) above.
  - c) When wearing approved protective headgear with harness attached, it need not be removed. Salute using the method described in (a) above.
3. For additional references see:  
Pleasure Driving – C245  
Driven Dressage – C519.3  
Combined Driving - Articles C928.4, C964.

## **ARTICLE C111 OUTSIDE ASSISTANCE**

See specific rules in Pleasure Driving, Driven Dressage, Coaching and Draft Equine and Combined Driving.

## **ARTICLE C112 WAIVER OF RULES**

1. Equestrian Canada rules pertaining to attire may be waived by judges and organizers due to local conditions. For example, physical inability to hold a whip or wear gloves.
2. Drivers who request a waiver of Equestrian Canada Rules must have the extraordinary circumstances approved by a judge and show management and must sign a disclaimer stating that this action is being taken at his or her own risk.

## **ARTICLE C113 DRESS OF DRIVER AND PASSENGERS**

1. Drivers and passengers should be dressed conservatively according to the style of the present day. Any attempt to introduce period costumes or gaudy trappings is discouraged, unless part of the class description in the Prize List or Omnibus.
2. Dress for the driver should conform to the type of turnout (i.e., Formal, Park, Country, Sporting).
  - a) In combined driving marathons or where it is specifically allowed in a Prize List or class description, less formal attire may be appropriate, but it should always be neat and clean.
  - b) In Pleasure Driving competitions, refer to Article C205.
3. Gentlemen must wear a coat or jacket while appearing in any class unless excused from doing so by the judge and/or show management. When accepting awards, gentlemen are requested to remove their hats. Approved protective headgear with harness attached need not be removed.
4. Ladies must wear a jacket, conservative dress, tailored suit, or slacks. Floppy hats are discouraged. "Shorts" are not permitted.

5. Unless otherwise specified, the driver shall wear a hat, an apron or knee rug and gloves. There are no penalties for wearing properly fitted, approved protective headgear in any class or competition.
6. Long sleeves and brown leather gloves are suggested for all drivers and passengers in a Pleasure Driving class and in Combined Driving Dressage and Cones competitions
7. Approved protective headgear worn properly is acceptable in all classes without penalty. See Article A905 and C102.10.
8. Sunglasses may be worn in bright sunlight without penalty.

## **CHAPTER 5 - GROOMS AND ATTENDANTS**

### **ARTICLE C114 GENERAL**

1. Groom requirements are listed under Article C209.1(c) for Pleasure Driving, Article C509.2 for Driven Dressage and Article C943.2 for Combined Driving. (See Article C102.6, requirements and exceptions for Junior drivers).
2. When grooms or passengers are required they must be closely available and capable of rendering assistance at all times. Failure to comply may incur elimination from a class or competition, or disqualification from an event.

### **ARTICLE C115 ATTIRE FOR GROOMS**

1. Grooms of either gender may wear stable livery (see Article C207.2) in any but the more formal vehicles where full livery (see Article C207.3) is appropriate. Where it is specifically allowed in the Prize List, less formal attire may be appropriate, but it should always be neat and clean. In all competitions, grooms shall wear a hat or approved protective headgear.
2. Approved protective headgear worn properly is acceptable in all classes without penalty. See Article A905, C102.10 and C928.
3. Sunglasses may be worn in bright sunlight without penalty.

## **CHAPTER 6 - THE HORSE**

### **ARTICLE C116 ELIGIBILITY OF HORSE**

1. The driving horse may be of any breed, color or size so long as it is capable of performing the required gaits.
2. Horses must be serviceably sound and must not show evidence of lameness, broken wind or impairment of vision in BOTH eyes. See C104.3.
3. Stallions are prohibited in all classes restricted to Juniors and classes restricted to Maiden, Novice and Limit drivers.
4. The “competition age” of any horse will be the age reached during the current calendar year.

### **ARTICLE C117 CLASSIFICATION BY SIZE**

1. For Pleasure Driving, see Article C212
2. For Combined Driving, see Article C930.4
3. Refer to Appendix 9-D or Article A1109 for method of measurement.
4. The following table illustrated height comparisons between Pleasure and Combined driving, Equestrian Canada, ADS, USEF and FEI rules.

Competition	cm	FEI-C	USEF-C	ADS-C	EC-C	EC-P	ADS-P	USEF-P
Height	>148	Horse						
Comparison		Pony (all turnouts)		Large Pony	Large Pony			> 14.2 hh
RULE REFERENCES	137.2				Med Pony			Pony (suggested) > 12.2 hh
FEI = 930								
USEF-C = DC915	127							
USEF-P = CP114	120							
ADS-P = PD212		Pony Pairs & 4's Only			Sm Pony			Sm Pony (suggested) > 39 inches
ADS-C = CD930	108				Sm Pony			
EC-P = C212	99							
EC-C = C930	<99	Not Recognized			VSE			

*Heights in cm are unshod. Add 1 cm if shod.*

### **RULE REFERENCES:**

- ADS-C ADS COMBINED DRIVING EVENTS, DRIVING TRIALS, ARENA DRIVING
- ADS-P ADS PLEASURE DRIVING CLASSES
- EC-C EQUESTRIAN CANADA COMBINED DRIVING EVENTS, DRIVING TRIALS, ARENA DRIVING
- EC-P EQUESTRIAN CANADA PLEASURE DRIVING CLASSES
- FEI FEI CLASSES (CAI -1\*, CAI-2\*)
- USEF-C USEF COMBINED DRIVING EVENTS
- USEF-P USEF CARRIAGE PLEASURE CLASSES

### **ARTICLE C118 TURNOUT FOR THE HORSE**

1. Braiding of the mane is optional. Any mane, tail or fetlock trimming may conform to breed standards. Tails are not braided.  
Exception: Tails may be braided if the length warrants to prevent the tail from getting caught in the wheel spokes of the vehicle.
2. The application of supplemental hair to mane or tail is prohibited. A tail set or use of any foreign substance to induce a high tail carriage is prohibited.
3. It is prohibited to tie a tail to a vehicle or harness.
4. In Pleasure Driving Competitions refer to Article C207. In Combined Driving Competitions, in Competition A (Dressage) bandages and brushing boots are not allowed under any circumstances. Failure to comply incurs elimination.
5. See Appendix 2-A – Turnout and Appointments for additional information on turnout for different types of vehicles.

## CHAPTER 7 - THE HARNESS

### ARTICLE C119 DRIVER'S RESPONSIBILITY

It is the driver's responsibility to see that the harness is in good condition, is clean and fits properly.

### ARTICLE C120 STYLE OF HARNESS

1. Equestrian Canada recognizes specific national types of harness.
2. Bridles should fit snugly to prevent catching on the vehicle or other pieces of harness. A throatlatch and a full noseband or cavesson are mandatory. A gullet strap is encouraged. Bits cannot be connected to reins by clips or snaps. Also see C207.3(b).
3. Black harness is considered appropriate with painted vehicles, with shaft and pole trimmings done in black. It is also considered appropriate with natural wood vehicles with iron parts painted any colour except brown. Shaft and pole trimmings, dash and fenders are done in black. Brown or russet harness is considered appropriate with:
  - a) Natural wood vehicles with brown or black iron; or
  - b) Painted vehicles with natural wood panels with any colour iron; or
  - c) Vehicles painted brown with brown iron.Shaft and pole trimmings should match the harness.
4. All metal furnishings should match, be secure and polished.
5. Breast collars are appropriate with lightweight vehicles. Full collars are suggested for heavy vehicles such as coaches, breaks, phaetons, dog carts, etc.
6. A correctly fitting harness saddle is important for the comfort of the horse. A wide saddle is suggested for two wheeled vehicles as more weight rests on the horse's back. Narrower saddles are more appropriate for four wheeled vehicles.
7. The tying of tongues is prohibited.
8. The use of kicking straps is permissible in Pleasure Driving classes, but should match the harness being used.

### ARTICLE C121 BITS

A bridle with reins attached to a bit is required for each horse. Bit burrs, gag bits and wire bits of any type are not permitted in EQUESTRIAN CANADA driving competitions or in exercise or warm-up areas. Bits cannot be connected to reins by clips or snaps.

## **CHAPTER 8 - THE VEHICLE**

### **ARTICLE C122 DRIVER'S RESPONSIBILITY**

It is the responsibility of the driver to see that the vehicle is in good repair and is structurally sound.

### **ARTICLE C123 STYLE/ELIGIBILITY**

1. Drivers should strive to present an appropriate turnout. "Appropriate" indicates the balance and pleasing appearance of the combination of horse and vehicle. Factors determining the above include compatible size, type and weight of horse and vehicle. The way of going of the horse may also affect the overall appearance, i.e., a high action horse is more suitable for a formal vehicle; the low going ground covering horse presents a more pleasing appearance put to a road or country type vehicle.

# APPENDICIES

## APPENDIX 1-A - EVENT SUMMARY TABLE

EC DRIVING	Competition	Classes	Event License* (Organizer)	Sport License* (Competitor)	Judge*	Technical Delegate*	Course Designer*	Vet
Recreation	TREC Driving	All	N/A	N/A	Knowledgeable Horseman	Not Required	Not Required	On Call
	Country Heritage	All	N/A	N/A				
	Ring and Obstacles	All	N/A	N/A				
Draft	Ring Classes	All						
	Obstacle Classes	All						
Pleasure	Cross Country	All	BRONZE	BRONZE	1-r or PTSO			
	Continuous Driving	All						
	Regional Championships	All						
	National Championships	All	GOLD	GOLD	1-r	1-r	1-r	
	Arena Trials	T/P	N/A	N/A	1-r or PTSO or Coach	Not Required		
	Arena Trials	I/A			1-r			
Combined Driving	Carrriage/Sleigh Derby	T/P/I			1-r or PTSO	≤15 entries Not Required >15 entries 1-r		
	Driving Trials	T/P	BRONZE	BRONZE	1-S		Not Required	
	Driving Trials	I			1-r or PTSO			
	Driving Trials	A	GOLD	GOLD	1-S and 1-r or 1 PTSO	1-r		
	Driving Trials	T/P	BRONZE	BRONZE	1-S and 1-r or 1 PTSO	1-r		
	CDE – 2 days				1-r or PTSO			
	CDE – 2 days	I			1-S and 1-r or 1 PTSO	1-r		
	CDE – 2 days	L2/A	GOLD	GOLD	1-S and 1-r or 1 PTSO	1-S	1-r	
	CDE – 3 days	T/P/I	BRONZE	BRONZE	1-S and 1-r or PTSO	1-r	Not Required	On grounds during inspections and Marathon
	CDE – 3 days	L2/A	GOLD	GOLD	1-S and 1-r	1-S	1-r	
Regional & National Championships	T/P/I/A							
FEEI	All							
PLATINUM								

\*Note: the requirements noted in this table are minimum requirements. Licensed Technical Delegates and/or Course Designers are always recommended even when not required. Requirements exceeding the minimum requirements are also acceptable.

Abbreviations:

CDE = Combined Driving Event    r = recorded official    S = Senior (or Registered) official    T = Training Division    P = Preliminary Division    I = Intermediate Division    A = Advanced Division

## APPENDIX 1-B – SAFETY CHECKLIST

*Athletes must complete a checklist similar to the following, and submit to a safety inspector before starting a Recreational Drive, Pleasure Competition or Combined Driving Event. Failure to comply may disqualify the entry. It is the Athlete's responsibility to continually evaluate and be responsible for the safety of his/her turnout.*

Inspection	Yes	No	N/A
<b>VEHICLE:</b>			
Wheels – checked in good condition			
Axles & 5 <sup>th</sup> wheel – inspected and properly lubricated			
King & singletree bolts – secure & condition in good condition			
Shafts / pole / singletrees –checked for soundness			
Shaft couples / pole housing – checked secure			
<b>HORSE:</b>			
Has entry received regular training in driving			
Does your entry stand quietly until directed to move off			
Have teeth been checked to assure comfort & acceptance of bit			
Are shoes secure and suitable to maintain footing			
Will entry be content to remain a safe distance from others			
Is your entry controllable in traffic and around others			
<b>HARNESS &amp; BITTING:</b>			
Checked for excessive wear			
Checked for correct fit			
Does your harness qualify under Articles C119, C120, C121; and C940, C942 (Combined Driving) or 119, C120, C120 C207 (Pleasure Driving)			
<b>ATHLETE:</b>			
Size/weight of vehicle & passenger load appropriate to prevailing conditions/competition			
Can you manage your turnout in the presence of unfamiliar horses			
Have you inspected your turnout thoroughly before driving off			
Are you confident in your driving skills to participate in this event			
Are you aware the bridle must NEVER be removed while put to or putting to a vehicle			
Protective headgear – approved – proper fit and securely fastened			
Protective vests – properly fitted and fastened - required for juniors			
Medical Armband – properly completed and displayed			
Means of calling for or signalling for emergency assistance			
<b>SPARES KIT:</b>			
Rein splice or spare rein			
Trace splice or spare trace			
Leather punch			
Halter and lead shank for each horse			
Spare hames strap if using full collars			
Pairs only: Spare whipple tree (if used)			
Teams only: Spare lead bar or main bar			

Responsibility accepted and completed/signed by Athlete: \_\_\_\_\_

Signature of Groom(s): \_\_\_\_\_

Signature of Navigator: \_\_\_\_\_

Received by Safety Inspector: \_\_\_\_\_ Date/time \_\_\_\_\_

# APPENDIX 1-C – SAMPLE EMERGENCY PREPAREDNESS PLAN

## Emergency Preparedness Plan

**EVENT** \_\_\_\_\_ **Date** \_\_\_\_\_

**EMERGENCIES** – report to the nearest official or show office immediately. When officials are not available, call 911 and report the following location. Arrange to meet the emergency responders and guide them to the accident location.

**Directions for Emergency responders:** \_\_\_\_\_

\_\_\_\_\_

\_\_\_\_\_

<b>Responsibility</b>	<b>Name</b>	<b>Radio</b>	<b>Cell</b>
Emergency Coordinator			
Technical Delegate			
President of Jury			
Show Manager			
Show office			
Security			
EMT – 1			
EMT – 2			
Veterinarian			
Site Manager			
Repair crew chief			
Announcer			

The Emergency Coordinator will be the prime contact for all activity associated with the accident and direct communications and activity for the above team.

The \_\_\_\_\_ will determine if the event is to be interrupted or discontinued, and when it may resume.

If an ambulance is needed, \_\_\_\_\_ will lead it to the scene. If the incident requires off-site transportation. Ambulance lights and sirens should not be used on competition grounds.

Management will be responsible to advise emergency contacts for anyone injured (if unable themselves) and ensure horses, vehicle and harness are cared for.

\_\_\_\_\_ will gather details of the accident/Injury, including witness statement and information for required reports.

Management must be informed each time medical personnel respond to an incident, regardless of the seriousness of the incident.

Only the Organizer may make statements to the general public or news media.



## **PART TWO - PLEASURE DRIVING COMPETITIONS**

### **CHAPTER 1 - GENERAL RULES**

#### **ARTICLE C201 OFFICIALS**

Requirements for Pleasure Driving Judges and Technical Delegates are defined in the Event Summary Table. A Ringmaster is recommended. In addition to the duties and responsibilities specified in the General Rules and the Rules for Pleasure Driving, Pleasure Driving Judges and Technical Delegates are bound by the Rules for Competition Officials – C601, C603.2, C604.2, C607.2, C608.2, C610.

Judges' decisions representing their individual preference are not protestable. Inquiries concerning irregularities or incidents during the Event/Show and the outcome of pleasure classes for technical reasons may be made at any time during the competition. Objections must be made to the Technical Delegate (or Show Secretary if no Technical Delegate) no more than one hour after the posting of class results.

#### **ARTICLE C202 NAME OF CLASS**

If show management wishes to offer a class described in Equestrian Canada rulebook, the class must be conducted as stated. If management wishes to alter a class to fit "house rules" they must change the name of the class to avoid confusing it with EQUESTRIAN CANADA rulebook class specifications. Such classes should be clearly stated in the Prize List and must include the "house rules" and judging criteria. In any case these altered conditions should conform to the spirit and intent of Equestrian Canada general rules for safety, conduct and cruelty.

1. Unless otherwise specified in the Prize List, these classes shall each be classified as a fully recognized EQUESTRIAN CANADA Points Class.
2. In the interests of safety, under no circumstances may wire wheeled vehicles be permitted on cross-country or in scurry classes, unless the Steward or Technical Delegate is satisfied that the vehicle is suitable.
3. Organizers wishing to present both pleasure driving and combined driving events concurrently may do so only if the disciplines are run as two separate competitions. Horses may not compete in both competitions.
4. Driven Dressage, Arena Driving and Two-Phase competitions may be presented concurrently with pleasure driving. Horses may compete in both competitions at management's discretion.

#### **ARTICLE C203 ENTRIES**

1. An entry is defined as a combination of horse(s), vehicle and driver and must be assigned a specific entry number. If a championship based on EQUESTRIAN CANADA rules is offered, a change of any part of the combination constitutes a different entry and must be assigned a separate number unless otherwise specified by the Organizer and published in the Prize List. In the event that a vehicle is disabled or judged unsafe to start or continue, management may authorize the substitution of another vehicle without issuing a new number.
2. All entries must have an entry number before entering any class. It is the driver's responsibility to display the proper number for the turnout entering the ring or obstacle

course. No award will be given to any Entry competing with an incorrect entry number.

3. An Entry may drive hors concours (H/C) in any competitions offered as part of a Pleasure Show at the discretion of the Organizer. See Article C236.

#### **ARTICLE C204 DIVISION OF LARGE CLASSES**

1. If conditions warrant, classes may be split by the judge, in consultation with the technical delegate and management. The size of the ring and the competition level of entries should be considered when determining if a class should be split. Unless the ring is very large, classes of more than 14 entries should be split .
2. The judge and/or management have discretion as to how the division is made, keeping in mind the following, when applicable:
  - Separation of multiple and single entries;
  - Separation of horses and ponies;
  - Separation of two- and four-wheeled vehicles.
3. Management has the option to have final placings determined by working off the leaders of each section or by awarding duplicate ribbons and/or trophies for each section as if they were separate classes.

#### **ARTICLE C205 DRIVER'S RESPONSIBILITY**

1. Excessive use of the voice, shouting or whistling to the horse may be penalized at the judge's discretion. The driver should strive to control the horse's movements with discreet use of vocal aids.
2. The driver must be prepared to enter the ring or obstacle course area when his/her class is called. After a reasonable wait, management may announce that a one-minute time limit will be invoked. When the appropriate time has elapsed, the gate or course will be closed and any entry not in the ring or at the course start will be excluded from the class. Management may give permission for the class to be held for an entry which requires an equipment change.
3. Prior notification must be given to the Technical Delegate of any drug administered to competing animals. All entries must give consent to having their animals tested by the Veterinarian. For information on permitted and prohibited substances, refer to the Rules of Equestrian Canada, Section A, General Regulations, Chapter 10 - *Equine Medication Control*.
4. In the case of an accident or equipment failure which necessitates repair or readjustment all groomers or passengers carried on the vehicle must dismount the vehicle. They should not remount until the problem has been corrected or the turnout deemed fit to continue. The exception would be in the case of a minor adjustment (such as trace down) when only the necessary groom need be put down. Appropriate penalties will be assessed according to class specifications.
5. All entries are expected to conform to the spirit and intent of the Equestrian Canada General Rules for safety. . It is the responsibility of each driver to ensure that harness and vehicle are in good repair, structurally sound, and safe for competition conditions. Turnouts without braking mechanisms (such as breeching, brakes, or tug stops with wrap girths) may be restricted from certain classes for safety reasons. Entries must not start any class with an unsafe turnout. The judge must eliminate an unsafe entry from any class. Repeated offenses may incur disqualification.

6. It is preferred that the driver sit on the right-hand side of the vehicle unless prevented by the construction of vehicle.
7. No change of driver is permitted except where specified in class conditions (i.e. Double Jeopardy Obstacles).
8. Drivers receiving outside assistance after the judging has begun will be penalized at the judge's discretion unless that assistance has been specifically allowed (example: assistance of groom/passenger heading a horse in a line-up or groom/navigator on Pleasure Drive).
9. While competing, outside assistance which requires elimination includes but is not limited to the following:
  - a) The use of auxiliary mechanical or electronic devices other than clocks or watches (eg. GPS devices, speedometers, heart rate monitors, etc. on the vehicle.
  - b) Directing the driver in any way except as permitted by individual class rules.
  - c) Anyone other than the driver handling the reins, whip, or brake.

## **ARTICLE C206 VEHICLES**

1. Management may restrict combined driving marathon vehicles from participation in pleasure driving competitions..
2. Wire wheeled and pneumatic tired vehicles may be permitted only at management's discretion and must be specified in the Prize List.  
**Exception:** antique vehicles with long wire spokes and hard rubber tires are allowed in all classes.
3. Management may allow the use of more than one vehicle under the same Entry number. This must be clearly explained in the Prize List.

## **ARTICLE C207 TURNOUT**

It is the responsibility of the driver to see that he and all attendants, grooms, passengers and horses are appropriately attired and turned out for the class in question. See Appendix 2-A for additional information.

1. **Attire for drivers, grooms, and passengers**
  - a) Drivers: Dress should conform to the type of turnout (i.e. Formal, Park, Country, Sporting, Commercial). Less traditional attire (example: Combined Driving Marathon attire) may be appropriate ONLY if it is specifically allowed in the Prize List or class description, otherwise a penalty or elimination may result. Except for certain commercial turnouts:
    - (i) Gentlemen must wear a coat or jacket while appearing in any class unless excused from doing so by the judge and/or show management. When accepting awards, gentlemen are requested to remove their hats unless wearing approved protective headgear (see C207.4).
    - (ii) Ladies must wear a conservative dress, tailored suit, or slacks. Floppy hats are discouraged.
    - (iii) Unless otherwise specified, the driver shall wear a hat, an apron or knee rug and gloves. (See Appendix 2-A - *Turnout and Appointments*)
  - b) Grooms: Grooms of either gender may wear stable livery in any but the more formal vehicles where full livery is appropriate. Where it is specifically allowed in a Prize List or class description, less formal attire may be appropriate, but it should always be neat and clean. In all competitions, grooms shall wear a hat or approved protective headgear (see C207.4).
    - (i) Stable Livery consists of one of the following:

- (1) A conservative suit, white shirt, dark tie, derby, dark shoes and leather gloves.
  - (2) A conservative jacket, jodhpurs or drill trousers, jodhpur or paddock boots, white shirt, stock or four-in-hand tie, leather gloves, derby or conservative cap.
  - (3) Hunting attire with a hunting derby or bowler.
  - (ii) Full Livery consists of a close fitting body coat with buttons of yellow or white metal to match the furnishings of the harness used (if possible), white breeches, black boots with tan tops, white stock, black top hat and brown leather gloves. The color of the coat remains the owner's preference, but preferred colors are conservative in nature and, where possible, complementary to the color of the vehicle.
  - c) Passengers: Dress should conform to the type of turnout (i.e. Formal, Park, Country, Sporting). Less traditional attire (example: Combined Driving Marathon attire) may be appropriate ONLY if it is specifically allowed in the Omnibus / Prize List or class description, otherwise a penalty or elimination may result. Except for certain Coaching and Commercial turnouts, all passengers should wear a hat, an apron or knee rug, and gloves. Approved protective headgear (see A905) is acceptable without penalty.
2. A **whip** should be carried in hand at all times while driving. A driver not in compliance may be eliminated or disqualified. The thong of the whip should be long enough to reach the shoulder of the farthest horse. A driver not in compliance with the above may be penalized. A whip with its thong tied in a manner which renders it incapable of reaching the farthest horse is not allowed. Failure to comply must be severely penalized.
3. **Harness**
- a) The harness should be in good condition, clean, fit properly and be appropriate for the style of vehicle.
    - b) Bridles should fit snugly to prevent catching on the vehicle or other pieces of harness. A throatlatch and a full noseband or cavesson are mandatory. Flash nosebands are strongly discouraged in pleasure driving classes. The use of a gullet strap is acceptable. Bits cannot be connected to reins by clips or snaps.
    - c) Black harness is considered appropriate with:
      - i) Painted vehicles
      - ii) Natural wood vehicle with iron parts painted any color except brown.
      - iii) Dash, fenders, shaft and pole trimmings should match the harness.
    - d) Russet harness is considered appropriate with:
      - i) Natural wood vehicle with brown or black iron
      - ii) Painted vehicle with natural wood panels with any color iron
      - iii) Vehicle that is painted brown with brown iron.
      - iv) Dash, fenders, shaft and pole trimmings should match the harness.
    - e) The collars of four-in-hand leaders are not to be tied together.
    - f) Boots - Bell boots, shin boots and wraps are allowed in Pleasure Driving classes and may be allowed in other classes, (except Driven Dressage), due to local conditions at the discretion of the judge. Boots protecting the sole of the foot are allowed in any pleasure class.
    - g) Standing Martingales are allowed for Stanhope or Park Gate Gig vehicles and George IV Phaetons, obstacle classes.
    - h) Check reins and martingales (except False Martingales) are prohibited in Obstacle classes. Failure to comply will incur elimination. In other classes,

check reins and martingales may be appropriate turnout for certain vehicles. See Appendix 1-A.

- i) Kicking straps are permissible but they should match the harness being used.
4. **Protective Headgear:** properly fastened, approved protective headgear – See Glossary, Section A – *Headgear Standards*. It must be properly fitted with harness secured. Approved protective headgear is appropriate for all competitors, assistants, grooms and passengers and may be worn without penalty in any class.
5. **Body Protectors (protective vests):** The use of body protectors is encouraged at all times when mounted or riding on a carriage. Judges may not penalize use of protective vests in any class.
6. **All juniors must wear approved protective headgear** defined above at all times while mounted or on a vehicle at the event location. Failure to comply will result in elimination. Approved protective headgear is appropriate for all competitors, assistants, grooms and passengers on the vehicle..

#### **ARTICLE C208 LEAVING ARENA**

1. No entry may leave the arena after judging has begun without permission from the judge.
2. Entries excused from any class must leave as instructed by the ringmaster or judge.
3. **Disqualify** - A Competitor, Horse, or Entry may be disqualified for being in violation of the Rules at any time.
  - a) Those who have been disqualified are prohibited from taking further part in the event and must forfeit all prizes won at the event.
  - b) Subsequent disciplinary action may be taken by Equestrian Canada.
4. **Eliminate** - An entry may be eliminated from a class as a penalty for contravening certain rules.
  - a) Elimination is listed with other penalties but it should be assumed that it may be applied where no other specific penalty is prescribed.
  - b) An eliminated entry is not eligible for an award in the class from which it is eliminated; however, the entry remains eligible to compete in the remaining classes of the show.
5. **Retire** - An entry not wishing to continue in any class for any reason may ask a judge for permission to retire.
  - a) A retired entry is not eligible for an award in the class from which it has retired; however, the entry remains eligible to compete in the remaining classes of the show.
6. **Withdraw** - An entry not wishing to continue competing for any reason may withdraw from the show.
  - a) A withdrawn entry is not eligible to compete in the remaining competitions of the show

#### **ARTICLE C209 GROOM/PASSENGER**

1. Minimum requirements
  - a) Four-in-hand and unicorn turnouts (except VSE): two grooms or passengers capable of rendering assistance at all times.
  - b) Pairs, Tandems, VSE four-in-hand and unicorn turnouts: one groom or passenger capable of rendering assistance at all times.
  - c) Single horse and pony turnouts: A groom/passenger is optional.

- Failure to comply may incur elimination or disqualification.
2. Passengers must be appropriately dressed and must wear a hat (see Article C113) or approved protective headgear.
  3. Grooms or passengers are not allowed to leave their respective positions on the vehicle while it is in motion or attempt to correct a problem without first being put down. Failure to comply will incur elimination.  
**Exceptions:** grooms dismounting to head the horses immediately prior to a halt or shifting weight to add balance to prevent an accident is permissible. Minor adjustments to harness may be made upon permission from the judge. A groom/passenger riding on the vehicle may be put down to assist with the adjustment without penalty except in dressage and obstacle classes. (See Articles C243.5 & C246.4)
  4. After judging begins, no attendant may enter the arena without the permission of the judge except in the case of accident or to prevent an accident.
  5. Leading a turnout into the ring or obstacle course start is considered outside assistance and is not permitted.
  6. Grooms may not stand behind the driver. If the vehicle does not permit the groom to sit behind the driver, permission must be obtained to allow the groom to sit beside the driver in obstacle classes. In Pleasure Driving ring classes, a groom/passenger may sit beside the driver.
  7. When a groom or passenger is put down to head the horse or horses during a line-up, he or she must remount when the driver moves off. This includes individual tests. Failure to comply shall be penalized. **Exception:** When receiving awards.
  8. A knowledgeable adult horseman, capable of rendering assistance in an emergency, must accompany Junior A and B drivers. (See Article C102.6).

## CHAPTER 2 - CLARIFICATION OF GAITS

### ARTICLE C210 DESCRIPTION OF GAITS

The following descriptions constitute Equestrian Canada approved standard for performance of each of the required gaits in a pleasure driving competition. Cantering and galloping are not allowed unless clearly stated in the Prize List. Management is strongly encouraged not to allow cantering or galloping in any class unless it is held in a securely enclosed area.

1. WALK – A free, regular and unconstrained walk of moderate extension is ideal. The horses should walk energetically, but calmly, with even and determined pace. The walk is a four-beat gait. A free, regular and unconstrained walk of moderate extension is ideal. The horses should walk energetically, but calmly, with even and determined pace. The walk is a four-beat gait.
2. TROT – The trot is a two beat diagonal gait.
  - a) SLOW TROT: The horse should maintain forward impulsion while showing submission to the bit. The trot is slower and more collected, but not to the degree required in the dressage collected trot. However, the horse should indicate willingness to be driven on the bit while maintaining a steady cadence.
  - b) WORKING TROT: This is the pace between the strong and the slow trot and more round than the strong trot. The horses go forward freely and straight; engaging the hind legs with good hock action; on a taut, but light, rein; the position being balanced and unconstrained. The steps should be as even as

possible. The hind feet touch the ground in the foot prints of the fore feet. The degree of energy and impulsion displayed at the working trot denotes clearly the degree of suppleness and balance of the horses.

- c) **STRONG TROT:** This is a clear, but not excessive, increase in pace and lengthening of stride while remaining well balanced and showing appropriate lateral flexion on turns. Light contact to be maintained. Excessive speed will be penalized.
3. **HALT:** Horses and vehicle should be brought to a complete square stop without abruptness or veering. At the halt, horses should stand attentive, motionless and straight with the weight evenly distributed over all four legs and be ready to move off at the slightest indication from the driver.
4. **REIN BACK:** Rein back is defined as a backward movement in which the legs are raised and set down simultaneously in diagonal pairs with the hind legs remaining well in line. To be performed in two parts:
  - a) The horse must move backward at least four steps in an unhurried manner with head flexed and straight, pushing the vehicle back evenly in a straight line. The driver should use quiet aids and light contact.
  - b) Move forward willingly to former position using the same quiet aids.
  - c) Road coaches and Park Drags are not to be asked to back up in the show ring.
5. **WORKING CANTER** – A forward, active pace with regular steps of three-time pace, the horse showing good balance, remaining on the bit without leaning on the hand and going forward with light cadenced steps and good hock action. A canter to the right, for instance will have the footfalls follow one another in the following sequence: left hind, left diagonal (simultaneously left fore and right hind), right fore, followed by a moment of suspension with all four feet off the ground before the next stride begins.

The quality of the canter is judged by the general impression, the regularity and lightness of the three-time pace. The horse must be on the bit and well engaged in the hindquarters with good hock action, and must have the ability to maintain his rhythm and natural balance throughout the movement and the transitions. The horse must remain straight on the straight lines.
6. **GALLOP** – A four-beat gait, faster than a canter.
7. **STRIDE** – A stride is defined as the cycle of movements that is completed when the horse's legs regain their initial positions. Length of stride refers to the amount of ground covered by an entire sequence.
8. **INTERMEDIATE GATE** – Breed specific gaits will be used in Divisions for non-trotting breeds.
9. In pleasure classes for mules and donkeys, the gaits are walk, slow trot, and working trot.
10. In Pleasure classes for Draft Equines, gaits may be limited to walk, slow trot, and working trot at the discretion of the organizer as published in the Prize List.
11. **PARK CLASS GAITS** – To be called for only in Park classes. See Article C221.

## ARTICLE C211 BREAK IN GAITS

Break in gait	Conditions	
<u>Break to canter or gallop</u>	4 or more full strides	
<u>Prolonged canter or gallop</u>	More than 6 full strides	
<u>Break to walk</u>	2 full strides at the walk	
<u>Break from walk</u>	3 full strides of any other gait or stopping	
<u>Stopping</u>	Obstacle classes. See Article C242	Pleasure Drives Pleasure Drive class rules. See C257

1. In a multiple turnout all horses must break for a penalty to be assessed.

## CHAPTER 3 - CLASS DIVISIONS

### ARTICLE C212 DIVISIONS BASED ON THE HORSE

1. If otherwise eligible, all equines are allowed to compete at any Equestrian Canada Pleasure Driving Show unless restricted by management. Such restrictions must be published in the Prize List.
2. Medium/large pony classes or divisions may be combined. Divisions are to be stated in the Prize List. Suggested divisions:

Horse	Over 14.2 hh	Over 148 cm *
Large pony	Over 13.2 hh to 14.2hh	Over 137 cm to 148 cm.*
Medium pony	12.2 hh to 13.2 hh	Over 120 cm to 137 cm.
Small pony	9.3 hh (39 in) up to 12.2hh	99 cm to 120 cm.
VSE	Under 39 in (9.3 hh)	Under 99 cm.
* Measurements unshod. Add 1 cm if shod.		
Note: Measurements for VSE, Small Pony and Medium Pony are shod/unshod.		

3. A registered horse of a breed permitting horses to be 14.2 or under (ie. Arabian, Morgan, Quarterhorse, etc.) may show in either division, but only one size division at the same show (ie. as a pony or a horse).
4. Draft Equine – Draft Equine classes or divisions may be divided. Suggested divisions:
  - a) Draft Pony – Under 14.2 hands, approximate weight less than 1200 pounds.
  - b) Draft Small – 14.2 to 16.2 hands, approximate weight 1200-1600 pounds.
  - c) Draft – over 16.2 hands, approximate weight greater than 1600 pounds.
5. Class or divisions offered for donkeys and/or mules may be divided by size.
6. A multiple turnout must be shown in the classes or division which accommodates the tallest horse.
7. The minimum competition age for a horse to compete is three years of age.
  - a) It is encouraged that three year olds be restricted to maiden, novice or limit classes and not be allowed to cross enter into other divisions.
  - b) In multiple turnouts the restrictions are to be applied considering the age of the youngest horse.
  - c) Restrictions must be clearly stated in the Prize List.
8. Pony height on USEF Measurement Cards will be honoured at EC-sanctioned Pleasure Events.



## ARTICLE C213 DIVISIONS BASED ON THE DRIVER

Divisions based on the status of the driver must be clearly described in the Prize List. Suggested divisions may include but are not limited to

1. Age (e.g., Junior, Adult).
1. Gender (e.g., Ladies' Driving Class, Gentlemen's Driving Class)..

## ARTICLE C214 DIVISIONS BASED ON EXPERIENCE

	Cumulative number of 1 <sup>st</sup> place wins	Minimum number of Pleasure Shows
Maiden	0	No minimum
Novice	< 3	3
Limit	< 6	3
Open	No limit	No minimum

1. Maiden \* - a driver or horse not having won a first-place ribbon in similar classes exceeding 3 or more entries in an EC-sanctioned driving competition.
2. Novice \* – a driver or horse not having won three first place ribbons in similar classes exceeding 3 or more entries in EC-sanctioned driving competitions.
3. Limit \* – a driver or horse not having won six first place ribbons in EC sanctioned driving competitions.
4. Open \* – open to all drivers and horses
5. Wins in classes of fewer than three entries and high point champion awards are not to affect Driver or Horse status.
6. Hors Concours entries (H/C) – See Article C236.

\* Note: Stallions are prohibited in all classes restricted to Juniors and Maiden, Novice or Limit drivers.

## ARTICLE C215 OTHER DIVISIONS

Restrictions for any division must be specified in the Prize List. Other Divisions may be offered including but not limited to the following:

1. Configuration of turnout – Single, Pair, Tandem, Unicorn, and 4-in-Hand.
2. Vehicle type – Antique, two-wheel, four-wheel, specific vehicle type, etc.
3. Special Vehicle Divisions – Organizers may define divisions by specific characteristics of and purposes for vehicles. Examples of special vehicle type divisions:
  - a) Marathon Division – open to marathon vehicles specifically built for the singular purpose of Combined Driving marathon use.
  - b) Traditional Division – open to vehicles with the traditional profile of an identifiable type, to resemble the design of a carriage built prior to the First World War. Vehicle may be of modern materials, but must have traditional springing
  - c) Contemporary Division – open to vehicles designed for use as a show vehicle, constructed primarily of modern materials with features including but not limited to: metal wheels, flush hubs, metal framing, metal shafts, torsion or shock absorber suspension, etc.
4. Local – for drivers residing within or horses stabled within a specified local area.
5. Breed – by breed or type of horse

## ARTICLE C216 DONKEYS AND MULES

21. All equines are allowed to compete unless restricted by management. Restrictions must be published in the Prize List.

**ARTICLE C217 CHAMPIONSHIPS AND YEAR-END AWARDS**

1. EC may accumulate points for entries at National sanctioned competitions for year-end awards, “high score”, or other cumulative championships for Driving.
2. When a championship for a division or a show is awarded on points:
  - a) All competitors must be given an equal opportunity to accumulate points.
  - b) All sections/divisions included in the championship must have an equal number of classes.
3. Management is strongly encouraged to post a scoreboard in a prominent place, updated throughout the competition and at least 30 minutes prior to making championship awards.
4. If a tie in championship points is to be decided either of the following will be used: the best placing in the Reinsmanship class or Working class if Reinsmanship is not offered or a drive-off using Pleasure Driving rules.
5. A tie for reserve may be decided by a coin flip if all parties agree.
6. All placings are final one hour after the conclusion of the show.

**CHAMPIONSHIP POINTS**

# entries →	6	5	4	3	2	1
1 <sup>st</sup> place	7	5	4	2	1	½
2 <sup>nd</sup> place	5	3	2	1	½	
3 <sup>rd</sup> place	3	2	1	½		
4 <sup>th</sup> place	2	1	½			
5 <sup>th</sup> place	1	½				
6 <sup>th</sup> place	½					

**CHAPTER 4 – CLASS SPECIFICATIONS**

**ARTICLE C218 TURNOUT**

1. A pleasure driving class in which entries are judged primarily on the performance and quality of each turnout.
2. To be shown both ways of the arena at a walk, slow trot, working trot, and strong trot. To stand quietly and to rein back.
3. To be judged:
  - 70% on the condition, fit and appropriateness of harness and vehicle, spares and appointments, neatness and appropriateness of attire and overall impression.
  - 30% on performance, manners and way of going.

**ARTICLE C219 WORKING**

1. A Pleasure Driving class in which entries are judged primarily on the suitability of the horse to provide a pleasant drive.

2. To be shown both ways of the arena at a walk, slow trot, working trot and strong trot. To stand quietly, both on the rail and while lined up, and to reinback.
3. All entries chosen for a workout may be worked both ways of the arena at any gait requested by the judge and/or may be asked to perform appropriate tests.
4. To be judged:
  - 70% on performance, manners and way of going of the horse(s).
  - 20% on the condition and fit of harness and vehicle.
  - 10% on neatness of attire.

#### **ARTICLE C220 LADIES' DRIVING CLASS**

1. Entries are judged primarily on the suitability of the turnout for a lady, with emphasis on manners.
2. To be shown both ways of the arena at a walk, slow trot, working trot, and strong trot.
3. Must rein back without resistance and must stand quietly at any location in the arena.
4. To be judged:
  - 50% on manners, elegance and suitability of the turnout for a lady,
  - 25% on skill of the driver,
  - 25% on Overall Impression.

#### **ARTICLE C221 GENTLEMEN'S DRIVING CLASS**

1. Entries are judged primarily on the suitability of the turnout for a gentleman, with emphasis on manners.
2. To be shown both ways of the arena at a walk, slow trot, working trot and strong trot. May show a degree of boldness but not excessive speed.
3. Must back without resistances and must stand still at any location in the arena.
4. To be judged:
  - 50% on manners and suitability of the turnout for a gentleman,
  - 25% on skill of the driver,
  - 25% on Overall Impression.

#### **ARTICLE C222 PARK**

1. A Pleasure driving class in which entries are judged primarily on gaits. (See Article C222.6).
2. This class is limited to park type horses and ponies.
3. TO be shown in an appropriate antique or antique-type vehicle. This class (division) can also be offered for Park Vehicles.
4. To be shown both ways of the arena at a park walk, park trot and show your horse (a smart trot without excessive speed). Clear rhythm and fluid action desired which is straight and true. To be judged on formality, performance, presence, manners and suitability and as a stylish harness horse.
5. TO BE PENALIZED: laboring action, mixed gaits; unbalanced action; pulling; tossing the head; fighting the bit; carrying the head to one side; leaving the hocks behind; strong out ; breaking of gait; loss of form due to excessive speed; bad manners. Entries should stand squarely and quietly in the lineup.
  - a) No overchecks, bicycle tires or martingales allowed.
  - b) Excessive length of toe or weighted shoe to be avoided.
  - c) Headers, if required, must come from the vehicle.
6. GAIT DEFINITIONS (to be called for only in Park classes):

- a) Park Walk: a four-beat collected gait, with good action and animation. It should have snap and easy control and be performed with great style, elegance and airiness of motion while displaying the horse good manners of the horse(s).
  - b) Park Trot: a two-beat, diagonal gait performed in a collected manner, with excessive speed to be penalized. The horse's energy should be directed toward animation rather than speed.
  - c) Show Your Horse: At this command, the driver has the privilege of showing the Park Driving Horse(s) to its (their) best advantage at the trot, but speed will be penalized.
7. TO BE JUDGED:
- 70% on performance, quality of horse, and manners
  - 30% on suitability of vehicle.

#### **ARTICLE C223 REINSMANSHIP**

- 1. A Pleasure Driving class in which entries are judged primarily on the ability and skill of the driver.
- 2. To be shown both ways of the ring at a walk, slow trot, working trot and strong trot. Drivers shall be required to rein back.
- 3. All drivers chosen for a workout may be worked at any gait requested by the judge and may be asked to perform appropriate tests.
- 4. The driver should be seated comfortably on the box so as to be relaxed and effective.
- 5. Either the one or two- handed method of driving is acceptable. Common to both methods: the elbows and arm should be close to the body with an allowing but steady hand enabling a consistent "feel" with the horse's mouth. Drivers should not be penalized or rewarded for using one general style over another.
- 6. TO BE JUDGED:
  - 75% on handling of reins and whip, control, posture, and overall impression of driver.
  - 25% on the condition of harness and vehicle and neatness of attire.

#### **ARTICLE C224 FREESTYLE REINSMANSHIP**

- 1. A Pleasure Driving class in which entries are judged individually on their ability and skill of the driver's execution of a self-designed driving test.
- 2. Eight required elements must be executed. The first element: enter/halt/ salute to be followed by these elements driven in any order.
 

Walk	Working trot	Slow trot
Strong trot	Halt (stand quietly)	Reinback

The final element, indicating the completion of the test: halt/salute/leave test area at a working trot. If an element is driven more than once, only the first occurrence will receive a score.
- 3. The suggested time limit is three minutes. Entries must complete the test within the time limit. Time begins at the signal from the judge after the entry has entered the test area. If the entry exceeds the time limit, no signal will be given until 30 seconds after the time limit at which time the entry will immediately leave the test area
- 4. Management must publish in the Prize List a description of the competition area including approximate dimensions.
- 5. Prior to the start of the show, entries must submit to the Organizer a clearly composed, legible description and diagram of their test on the Freestyle Reinsmanship Form.

6. Music may be allowed at management’s discretion.
7. Overall impression will decide ties.
8. Scoring: half-points may be used for scoring all elements.  
 Handling of reins and whip, control, posture, 8 elements  
 ..... maximum 10 points each.  
 Overall impression of the driver .....maximum 10 points  
 Best possible total score is 90 points.
9. Penalties:  
 Failure to perform any element.....0 points  
 Exceeding the time limit ..... 5-point deduction

**ARTICLE C225 SUPER REINSMANSHIP**  
 [reserved for future development]

**CHAPTER 5 – CLASS SPECIFICATIONS: COMBINED CLASSES**  
**Section A – Introduction and General Rules**

**ARTICLE C226 INTRODUCTION**

In combination classes the driver is asked to drive for a portion of the class and then to ride for the remainder of the class.

**ARTICLE C227 GENERAL RULES**

1. The entry must be shown by the same person in all sections or by one in the drive section and another in the ride section(s) at management’s discretion. The conditions must be clearly explained in the Prize List.
2. Up to 2 grooms or attendants may assist with unharnessing and saddling.
3. A bridle with reins attached and passed through the saddle terrets must be in place and in the hands of a competent person whenever a horse is put to a vehicle. Failure to comply will incur elimination. (See Article C106.1).
4. The judge may not request entries to be reharnessed after performing under saddle.
5. The judge may allow vehicles to remain in the arena or request that they be removed. If vehicles are removed, additional attendants may enter the arena to assist. If allowed to remain in the arena, a groom is permitted to attend the vehicle and wheel horse in a sporting tandem class.
6. Where approved protective headgear is required, it is the responsibility of the competitor (or Parent or Guardian in the case of a junior competitor) to see that the headgear complies with the current headgear standards and is properly fitted and in good condition.
7. In combination hunter and sporting tandem classes, jumps must be adjusted for horses and ponies, regardless of whether they are competing separately or one against the other. Ponies jump 2’- 2’6’’ (.609m-.762m) and horses 2’6’’-3’ (.762m-.914m). (See Article C117.)
8. Riders must be provided a practice jump prior to any class in which jumping is required. A diagram of the course must be posted at least one hour before class time.

**Section B – Class Conditions**

## **ARTICLE C228 DRIVE AND RIDE**

Single horse to be shown in two concurrent sections:

1. In Harness: To be shown to a suitable pleasure driving vehicle, both ways of the arena at a walk, slow trot, working trot, and strong trot. To stand quietly and to rein back.
2. Under Saddle: To be shown both ways of the arena at a walk, trot, and canter. To stand quietly and to rein back.
3. To be judged:
  - 50% on performance, manners, way of going and suitability in harness.
  - 50% on performance, manners, and way of going under saddle.

## **ARTICLE C229 COMBINATION HUNTER**

A Single horse entry to be shown in two or three successive sections:

1. In Harness: To be shown to a suitable pleasure driving vehicle, both ways of the arena at a walk, slow trot, working trot, and strong trot. To stand quietly and to rein back.
2. Under Saddle: To be shown under saddle both ways of the arena at a walk, trot, canter. To stand quietly and to rein back. Additional tests may include mounting and dismounting, opening a gate, etc.
3. Over Fences: To be shown over a course of no more than four fences (combinations are not permitted). Approved protective headgear must be worn. (See Article C102.10, and General Regulations, Article A905.
4. To be judged:
  - 40% on performance, manners, way of going and suitability in harness.
  - 30% on performance, manners, and way of going under saddle.
  - 30% on hunting performance over fences.
5. Show organizers may omit the Under Saddle section, in which case the following percentages shall apply:
  - 50% on performance, manners, way of going and suitability in harness.
  - 50% on hunting performance over fences.

## **ARTICLE C230 SPORTING TANDEM**

In sporting tandem classes, the leader and wheel horse need not be matched as to color, size, way of going, or breed. To be shown in two successive sections:

1. In Harness: To be shown to a suitable tandem vehicle with leader wearing a hunting saddle, hunting bridle and breast collar. To be shown both ways of the arena at a walk, slow trot, working trot and strong trot. When the wheel horse is performing the required trot gaits, the leader may be allowed to canter. To stand quietly, and to rein back. Entries may be asked individually to execute a figure of eight.
2. Under Saddle: The leader to be shown under saddle both ways of the arena at a walk, trot, canter, and hand gallop. To stand quietly and to rein back. Entries may be asked individually to jump two fences. Approved protective headgear must be worn (See Article C102.10, and General Regulations, Article A905).  
  
To be judged:
  - 60% on performance, manners and way of going in harness.
  - 40% on performance, manners and way of going under saddle.

## **CHAPTER 6 – CLASS SPECIFICATIONS: SPECIALTY CLASSES**

## **ARTICLE C231 CONCOURS D'ELEGANCE**

1. The class may be judged:
  - a) As a separate class.
  - b) In conjunction with a specific class or classes as designated by the organizer.
  - c) By overall impression throughout the competition.Whichever method is to be used, it must be clearly explained in the Prize List.
2. The entry fee for the class remains the option of the management, however, if the class is judged on an overall impression throughout the competition, it is recommended that no entry fee be charged and all participants be eligible.
3. Management may invite a local dignitary or celebrity to act as an honorary judge, and an EQUESTRIAN CANADA recognized driving judge may also be in the ring.
4. The essence of the competition is the word "Elegance". The winner will be the turnout which, in the opinion of the judge, presents the most elegant effect. This will include vehicle, harness, appointments, horses, driver, passengers, grooms, etc., but above all, general impression is most important. Vehicle and harness may be inspected to ensure thoughtful restoration and careful maintenance.
5. Attention will be paid to the personal appearance of the driver, grooms, and passengers as it contributes to the overall picture. Period costumes are definitely prohibited, unless otherwise stated in the Prize List. Performance will not be judged unless it detracts from the elegance of the turnout.

## **ARTICLE C232 CARRIAGE DOG CLASS**

1. Judged primarily on the suitability of the dog to serve as a companion (maximum of one dog per vehicle). To be judged both ways in the arena at a walk, slow trot and working trot.
  - a) The dog should be standing, lying down or seated on the vehicle or should run behind, beside or at the axle of the vehicle.
  - b) The dog must be under control at all times.
  - c) The dog must not be led on the ground from the vehicle or be restrained by being tied to the vehicle, driver or passenger.
  - d) The driver should not hold the dog, and the dog should not interfere with the driver in any way.
2. The dog may be of any breed.
3. To be judged:
  - 60% on the suitability of the dog to serve as a companion..
  - 30% on the performance, manners and way of going of the horse(s)
  - 10% on the overall impression of the turnout, including the dog.Entries with a dog clearly not under control may be eliminated.
4. As a variation, the spectators, in the form of applause, may judge this class. The judge would stand behind each entry and raise a hand, asking the spectators to respond. If this method of judging is to be used, it must be so stated in the Prize List.

## **ARTICLE 233 PICNIC CLASS**

1. A picnic appropriate to the turnout and number of participants must be carried on the vehicle. All picnic participants must be on the carriage during the ring section of the class and be present in the staging section.
2. A class in two sections: a performance section and a staging section. Percentages may be adjusted by the Organizer, provided the percentages are published in the Prize list.
  - a) Performance section – 25%
    - To be judged both ways of the ring at a walk, slow trot and working trot. Not to be asked for a strong trot. Park gaits (see Article 210.11) may be used if specified in the Prize list. May be asked to rein back. To stand quietly in the lineup.
    - To be judged on performance, manners, overall impression.
  - b) Staging section – 75%
    - At the conclusion of the ring section, competitors will be directed to the staging area to unhitch and set up a picnic. Horses to be removed to the stable area. The picnic will then be judged as part of the class. Staging area may include tables and chairs for use by each turnout.
    - To be judged on quality of picnic presentation.

## **CHAPTER 7 – CLASS SPECIFICATIONS: PLEASURE OBSTACLE DRIVING**

### **Section A – Introduction and Geeral Rules**

#### **ARTICLE C234 ATTIRE**

1. Drivers should dress appropriately when competing in any pleasure driving class, including obstacles. This should be recommended show attire unless otherwise specified in the Prize List or by a judge at the show. (See Article C113.)

#### **ARTICLE C235 PARTICIPATION**

1. A horse may not be entered more than once in the same obstacle class, except as part of a multiple.
2. A groom/passenger may compete as a driver on the same course.
3. No one may stand behind the driver unless the vehicle does not allow seating beside or behind the driver.
4. For hors concours (H/C) entries, see article C237.3

#### **ARTICLE C236 COURSE WALK**

1. Drivers must be allowed time to walk the course prior to the start of a class and to inspect each obstacle.
2. While walking the course, drivers shall not alter, adjust or in any way move an obstacle, or any part thereof. Should a competitor have any question regarding a specific obstacle, he/she should call it to the attention of the technical delegate for clarification and/or adjustment.

#### **ARTICLE C237 SCHOOLING, HORS CONCOURS (H/C)**

1. A practice obstacle must be provided for use in a specified area. Times for the use of the area may be controlled by management.



2. Unless expressly permitted by the Organizer, driving, leading, or riding horses or from permitting the horses to be driven, led, or ridden on any course used for competition at any time prior or after to that competition is prohibited. Failure to comply incurs elimination.
3. Within any Division, hors concours (H/C) entries may be allowed at the discretion of the Organizer as published in the Prize List. These entries are not eligible for competition and will receive no score or placing in any class. At the discretion of the organizer, a horse and/or driver may drive as an H/C entry on the same courses used in competition after they have competed on those courses.

**ARTICLE C238 THE COURSE**

1. The course may consist of Start and Finish markers, decorative materials and drivable obstacles consisting of a number markers and paired cones or other materials such as rails, fence panels, barrels, etc. Cone pairs may be numbered with markers placed on the cones themselves.
2. Unless otherwise specified in class rules, each obstacle must be numbered consecutively and marked with red on the right, white on the left (**Exceptions:** Scurry, Pick Your Route and Gambler’s Choice classes). In Reverse Psychology, Double Jeopardy classes, a different colored set of numbers may be placed to indicate the required “reverse” course. Any obstacle that cannot be clearly marked, for example, a figure eight or an obstacle that requires a back-up must have a clearly drawn pattern explaining the correct entrance, exit and required path on the course diagram. Within courses that consist of numbered obstacles, it is suggested that the number of an obstacle should be visible from the obstacle before it; i.e. #3 visible from #2; #4 from #3, etc. Only in Gambler’s Choice classes are point values displayed..
3. Obstacles requiring halt or backup are not permitted except in a Gambler’s Choice class.
4. Off-course – see Article C243.1.
5. When a disturbance or dislodgement occurs at a complicated obstacle (figure of eight, U-turn, L-turn, etc.), the intended pattern must be completed as closely as the disturbance or dislodgement will allow or the obstacle will be considered driven incorrectly and scored under the rules for each specific class.
6. A course diagram and applicable time allowed must be posted at least two hours before the start of the class.
7. Start and Finish lines for all obstacle courses should be a minimum of 3 metres wide.

**ARTICLE C239 WIDTH OF OBSTACLES**

1. The track width is measured at ground level on the widest track width of the vehicle. An allowance may be added for multiple horses that are wider than the wheel width of the vehicle.
2. a) Suggested obstacle clearances:
 

Classes emphasizing precision .....	8-10” .....	20-25 cm
Classes emphasizing speed	12-16”.....	30-40 cm
4-in-hand Classes .....	16-20” .....	40-50 cm

  - a) Junior, Maiden, Novice and Limit classes may benefit from wider clearances.
  - b) For classes that emphasize speed, it may suit local conditions to use one wide clearance for all entries, such as 80 inches (200 cm).
3. Following are minimum clearances for multiple obstacles:
 

L-shaped Obstacle .....	12 ft (4 m)
U-shaped Obstacle.....	12 ft (4 m) in & 16.5 ft (5 m) out

4. The metric conversion chart and the end of this publication is a guide for the use of management and/or course designer. Either system of measuring can be used depending on the equipment available and event tradition.

### ***TYPICAL OBSTACLE DESIGNS***

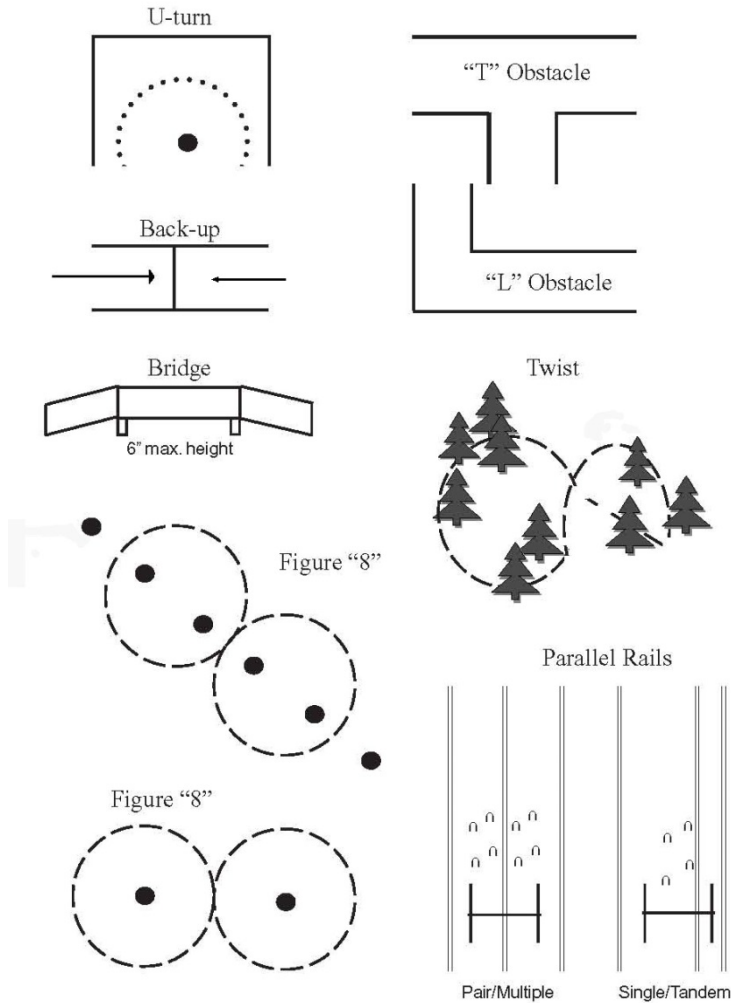

### **ARTICLE C240 MEASUREMENT OF OBSTACLES**

1. For "Traffic Cones", adjustment is made as follows:
  - a) The tread width of each vehicle should be taken at the ground on the widest pair of wheels. The allowance is added and the cones aligned and adjusted from corner to corner. (See Illustration below). This allows the greatest distance between the corner of the base and the upright portion of the cone. The taper of the cone provides clearance for normal hubs or whiffle trees or splinter bars.

- b) If a whiffle tree or splinter bar proves to be too wide for this arrangement, the cones may be adjusted using the whiffle tree's measurement plus the appropriate allowance, measured at a height on the cone at the same height that the whiffle tree is above the ground. (See Illustration of Cones.)

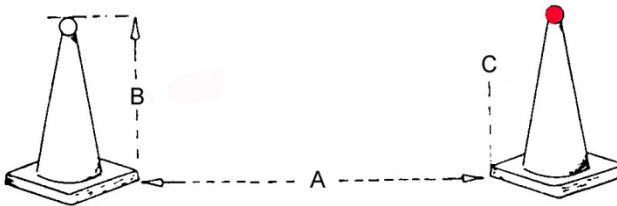

ILLUSTRATION OF CONES

2. On markers with perpendicular sides, adjustment for the widest part of the vehicle at the highest part of the marker may be made.
3. Care should be taken when numbers are placed to ensure that the numbers do not protrude inside the markers where they might be hit without hitting the obstacle itself. (See Article C237.2.)
4. It is the responsibility of the Technical Delegate to ensure that each set of markers is properly adjusted.

#### ARTICLE C241 TIME ALLOWED

1. All obstacle courses should be accurately measured with a measuring wheel, if possible, or tape line.
2. The time allowed is calculated by dividing the course measurement by the set speed for each class. Be sure to use a drivable line from obstacle to obstacle when measuring the course length.
3. Suggested Speeds:

VSE (Singles/pairs)	180 mpm	590 fpm
Singles/Pairs (Horse & Pony)	220 mpm	725 fpm
Tandem/4 Horses	200 mpm	650 fpm
Tandem/4 Pony	190 mpm	620 fpm
Tandem/4 VSE	170 mpm	560 fpm

4. Time Limits are twice the Time Allowed.
5. Any obstacle class in which placings are decided using a total time, does not require calculating a "time allowed". A time limit may be set at management's discretion, allowing a reasonably easy speed required to complete the course, keeping in mind the tightness of turns and limitations of the arena.

#### ARTICLE C242 TIMING

1. Timing with Stopwatches - Time is taken from the moment the first horse's nose crosses the starting line until the first horse's nose crosses the finish line, except where specifically noted in class specifications, i.e., Fault and Out, Progressive, etc.

2. Timing with Electronic Timers - Time is taken from the moment the photo cell beam is broken (by the first part of the turnout to reach the starting line) until the beam is broken at the finish.
3. Timing of Stop - If it becomes necessary to stop a competitor for any reason (marker blown over, unauthorized animal on course, etc.) a signal will be given and time stopped. The driver will be allowed to go back far enough to regain momentum and wait. A signal will be given when the driver must resume the course. The timing watch will be restarted when the competitor reaches the point at which time was stopped.
4. Signals from the judge to the driver should be audible signals such as a whistle, horn or bell.
5. Course time must be recorded manually or electronically to the hundredths of a second.

#### **ARTICLE C243    DISOBEDIENCE**

Disobediences are penalized as stated in the individual class specifications. They are defined as follows:

1. A run-out is defined as evading an obstacle to be driven or the finish line..
2. A refusal is defined as stopping and stepping back or sideways before an obstacle.
  - a) Stopping in front of an obstacle without dislodging it and without backing up followed immediately by driving cleanly through is not penalized.
  - b) If the halt is prolonged or if the horse backs even a single step voluntarily or not, a refusal is incurred.
  - c) If in the commission of the refusal any part of an obstacle is disturbed and class specifications require repair or resetting, the procedure outlined in Article C241.3 will apply.

#### **ARTICLE C244    OFF-COURSE**

1. Unless otherwise specified in individual class rules, a driver is off-course if:
  - a) a required obstacle is not driven;
  - b) the Start or Finish line is not driven;
  - c) an obstacle is driven in reverse direction, out of sequence or driven twice;
  - d) the Start or Finish line is driven in reverse direction, out of sequence or driven twice;
  - e) the entire turnout (all horses and all wheels of the vehicle) fails to pass through the obstacle or the Start/Finish markers; or
  - f) an entry disturbs any part of an obstacle out of its driving sequence

#### **ARTICLE C245    TIES IN PLACING**

1. Unless otherwise specified in individual class rules:
 

Low total time basis - For classes determined on a low total time basis, the competitor with the lowest course fault total will be placed ahead of competitors with higher course fault totals.

Low fault basis - For classes determined on a low fault basis, the competitor with the fastest time will be placed ahead of the competitors with a slower time.

High-point basis - For classes determined on a high-point basis, the competitor with the fastest time will be placed ahead of the competitor with a slower time.

In either case, if ties still remain, ties may remain or be resolved by the flip of a coin or a drive-off at the discretion of the judge in consultation with the organizer.

2. If two entries under the same ownership are tied, the owner may designate the order of finish.
3. Any competitor who advises the judge that he/she will not participate in a drive-off shall be placed last of the competitors in that drive-off. Should more than one of the tied competitors elect not to participate, all those not participating shall remain tied among themselves. Should there be only one remaining competitor, he/she is required to attempt at least the first obstacle in order to be placed first in the drive-off.
4. Except in the Fault-and-Out class, when two or more competitors incur elimination during a drive-off, they remain tied regardless of the cause of elimination or point at which it occurred. A competitor who voluntarily withdraws must always be placed after a competitor who has been eliminated in the same drive-off.

## **Section B – Obstacle Driving Class Conditions**

### **ARTICLE C246 SALUTE**

A salute is not required before competing in any Obstacle Driving Class.

### **ARTICLE C247 PENALTIES**

Unless otherwise specified, these penalties will apply to all Obstacle classes. Additional penalties will apply as specified in individual class rules. (See Article 211 Break in Gaits).

1	Knocking over start or finish marker	5 seconds
2	Knocking down or dislodging a ball or any part of obstacle any time while on course	5 seconds
3	Break to canter (See Article C211)	
	1st break to canter .....	5 seconds
	2nd break to canter.....	5 seconds
	3rd break to canter .....	5 seconds
	4th break to canter .....	Elimination
	Prolonged canter .....	Elimination
4	Disobedience or groom(s) dismounting (cumulative over course)	
	1st incident .....	5 seconds
	2nd incident .....	10 seconds
	3rd incident .....	Elimination
5	Starting before signal	Elimination
6	Failure to cross starting line within one minute of signal	Elimination
7	Off-course	Elimination
8	Outside assistance	Elimination
9	Failure to carry whip (Article C207.2)	Elimination
10	Use of a tie-down or overcheck	Elimination
11	Breakage of harness or vehicle	Elimination
12	Entries that overturn	Elimination
13	Failure of entire entry to pass through start or finish markers	Elimination

## **ARTICLE C248                   TIMED OBSTACLES**

1. To be driven over a prescribed course of obstacles. The number of obstacles shall be proportionate to the dimensions of the driving area. Not to exceed 20 obstacles.
2. After passing the starting line, the driver shall proceed through each obstacle in order to the designated finish line.
3. Course faults are assessed as penalty seconds and are added to the driver's elapsed time. Placings are determined on a low total time basis

## **ARTICLE C249   SPECIALTY TIME COMPETITIONS**

### **A. Scurry Obstacle**

1. To be driven over a course of unnumbered obstacles consisting of cones and balls, not to exceed 10 obstacles.
2. After passing through the Start markers from any direction, the driver shall proceed through each obstacle from any direction, in any order. Each obstacle must be driven once. Upon completion of the course, the driver must pass through the Finish markers from any direction, where time will be taken.
3. Refusals and run-outs will not be penalized.
4. Course faults will be scored as penalty seconds and added to the driver's elapsed time. Placings will be determined on a low total time basis. Ties for first place will be broken by a drive-off unless otherwise stated in the Prize List.
5. Ties for first place will be broken by a drive-off unless otherwise stated in the Prize List. (See Article C244 – Ties in Placing).
6. Penalties (See Article C246)

### **B. Town and Country Obstacles**

1. Same rules as Time Obstacles (Article C247) with the following **Exceptions**:
  - a) Obstacles are set at 2 meters (80 inches) for all competitors.
  - b) At least 30% of the obstacles must not be a pair of cones, but instead an obstacle that could be encountered while out driving through town or country (mail box and cones; trash barrel and cone; flagpole and cone; fence section and cone; bridge; poles set like guardrails; woodpiles; artificial animals. (These should be set at a distance from a pair of cones to avoid frightening animals).

### **C. Double Jeopardy Obstacles**

1. To be driven over a prescribed course of obstacles (paired markers) by an entry with two drivers. From 8-10 obstacles are recommended as a course length, but the number may be adjusted to be proportionate to the dimensions of the driving area.
2. After passing through the Start markers, the first driver shall proceed through each obstacle and through the designated Finish markers, where time is stopped. After the vehicle comes to a halt, the reins and whip are transferred to the second driver. Only after there is complete control of the reins and whip may the second driver proceed as follows: Beginning with the designated Start markers, the time is continued for the reverse course, continuing through the obstacles in reverse order and in the reverse direction and through the designated Finish markers for the reverse course. It is recommended that a different colored set of numbers be placed to indicate the required "reverse" course.
3. Failure to come to a halt before the exchange of reins and whip will incur elimination.

4. Course faults are as listed in Article C246 - Penalties. Course faults are scored as penalty seconds and are added to the driver's elapsed time. Placings are determined on a low total time basis. See C244 for ties.
5. Entries may be stopped by a signal from the judge before driving through the designated Start markers for the reverse course to allow dislodged/disturbed obstacles to be rebuilt. See Article C241.3.

**D. Reverse Psychology Obstacles**

1. To be driven over a prescribed course of obstacles (paired markers). From 8-10 obstacles are recommended as a course length, but the number may be adjusted to be proportionate to the dimensions of the driving area.
2. After passing through the Start markers, all the obstacles shall be driven in the correct sequence. After completing the highest-numbered obstacle, the driver will then turn and drive that obstacle in the reverse direction and continue to drive all the remaining obstacles in reverse order and in the reverse direction and through the Finish markers where timing will stop.
3. Course faults are as listed in Article C246.C. Course faults are scored as penalty seconds and are added to the driver's elapsed time. Placings are determined on a low total time basis. See C244 for ties.
4. Entries may be stopped by a signal from the judge after completing the highest-numbered obstacle to allow dislodged/disturbed obstacles to be rebuilt. See Article C241.3.

**E. Pick Your Route Obstacles**

1. To be driven over a course of obstacles (paired markers) with no set route. The number of obstacles to be proportionate to the dimensions of the driving area. Not to exceed 20 obstacles.
2. Typically obstacles in this type of class are not measured for each entry, but are set at 200 cm or 80 inches at the start of the competition, and only reset in the event of a knockdown.
3. After passing through the Starting markers, the driver shall proceed through each obstacle to the designated Finish markers, choosing his/her own route. Each obstacle and the start and finish lines to be negotiated once and only once, but may be driven in either direction.
4. Course faults are scored as penalty seconds and are added to the driver's elapsed time. Placings are determined on a low total time basis. See C244 for ties.
5. Penalties (See Article C246).

1	Driving through an obstacle again	Elimination
2	Missing an obstacle	Elimination
3	Exceeding time limit (2 X time allowed)	Elimination

**F. Your Route / My Route Obstacles**

1. To be driven over a course of 10 numbered obstacles (paired markers).
2. The suggested minimum obstacle clearance is 2 meters (80 inches) for paired markers and a minimum of 3.6 meters (12 feet) for multiple obstacles such as “L” and “U” shapes.

3. Your route: After passing through the Start markers, the driver shall drive through all 10 obstacles in the correct sequence and direction.
4. My route: After completing obstacle #10 the competitor will continue without passing through the Start/Finish markers by driving all obstacle a second time, in any sequence and in either direction. Time will be taken when passing through the Finish markers in either direction.
5. Entries may be stopped by a signal from the judge after completing the #10 obstacle to allow dislodged/disturbed obstacles to be rebuilt. See Article C241.3.
6. Course faults are assessed as penalty seconds and are added to the driver's elapsed time.
7. Placings are determined on a low total time basis. See C244 for ties.
8. Penalties (See Article C246).

1	Failure to drive obstacles 1-10 in order	Elimination
2	Omitting and obstacle or driving an obstacle twice in the second half of the round	Elimination
3	Passing through Start or Finish marker more than once	Elimination
4	Exceeding time limit (2 X time allowed)	Elimination

#### **ARTICLE C250 HIGH POINT COMPETITIONS**

1. Unless otherwise specified, these penalties will apply where applicable to all High-Point Competitions.
2. Additional penalties will apply as specified in individual class rules.
3. Penalties

<b>PENALTIES IN HIGH-POINT COMPETITIONS</b>	
Starting before the signal	Elimination
Failure to cross start line within one minute	Elimination
Outside assistance	Elimination
Failure to carry a whip (Article 207.2)	Elimination
Use of a tie-down or overcheck	Elimination
Breakage of harness or vehicle	Elimination
Entries that overturn	Elimination
Prolonged canter	Elimination
Failure of entire entry to pass through Start or Finish markers	Elimination
Off course	Elimination



## **A. Fault and Out Obstacles**

1. A timed course of numbered obstacles to be driven at the trot. The number of obstacles to be proportionate to the dimensions of the driving area and not to exceed 10 obstacles.
2. After passing through the Start markers, the driver shall proceed through each consecutively numbered obstacle, in order, until the allowed time expires or an obstacle is dislodged or disobedience occurs.
3. If all the obstacles are driven cleanly before the allowed time expires, the driver will begin the course again starting with Obstacle #1 without having to pass through the Start markers. However, passing through the Start Markers more than once is not considered "off course" and is not penalized.
4. Two points will be scored for each obstacle cleared before the time allowed expires, a disobedience occurs or an obstacle dislodged.
5. No points will be awarded for an incorrectly driven obstacle. If the obstacle is incorrectly driven but not disturbed, it may be attempted again.
6. When the allowed time expires, a disobedience occurs or an obstacle is dislodged, a signal will be given. The driver shall then proceed through the next consecutively numbered obstacle. The time will be taken when the rear axle clears this obstacle. If that obstacle is cleared, on point is scored. If it is dislodged, no points for that dislodged obstacle are scored, but the time is still taken.
7. The score of a driver who fails to drive the next consecutively numbered obstacle after the whistle is blown shall count, up to the point where the signal is given, but the competitor must be placed after those with an equal score and time.
8. Placings will be determined by the greatest number of points. Time will decide ties. If a tie remains with equal points and time, the winner will be decided by a drive-off.
9. Penalties (See Article C249.3).

## **B. Progressive Obstacles**

1. To be driven at the trot over a course of six numbered obstacles which will be adjusted to the following clearances: #1 - 20" (50 cm), #2 - 16" (40cm), #3 - 12" (30cm), #4 - 8" (20 cm), #5 - 4" (10 cm), #6 - 2" (5 cm).
2. After passing the starting line, the entry will proceed through each obstacle, in order, until finishing the course or dislodging an obstacle.
3. Scoring:
  - a) Time to be recorded when the rear axle clears the last obstacle. Points accumulated to that point count.
  - b) Time to be recorded when an obstacle is dislodged. Points accumulated to that point count.
  - c) For a disobedience or for going off course, points accumulated to that point count, however, no time will be recorded.
  - d) Two points given for each set of cones cleared. No points given for dislodged obstacle.
  - e) Placings determined on a high point basis. See C244 for ties.
  - f) Entries with accumulated points and no recorded time are placed after those with equal points and recorded times.
4. Penalties (See Article C249.3).

<b>PENALTIES IN PROGRESSIVE OBSTACLES</b>	
Dislodging an obstacle	Accumulated points and time recorded to that point
Break in gait (to canter or walk) see Article C211)	Accumulated points and time recorded to that point
Disobedience	Accumulated points count, no time recorded
Off course.	Accumulated points count, no time recorded
Groom(s) dismounting.	Accumulated points count, no time recorded

### C. Gambler's Choice Obstacles

- To be driven over a course of unnumbered obstacles each carrying a specific point value.
- Each driver has the same allowed time to negotiate as many obstacles as possible. Each obstacle is assigned a point value according to its degree of difficulty and each driver tries to amass as high a score as possible within the time allowed.
- After passing through the Start markers, the driver may drive through the obstacles, in any order, from any direction. Each obstacle may be driven twice, but not in succession. If driven a third time, no points will be awarded.
- No obstacle may be driven a second time once it has been disturbed. (**Exception:** obstacles which are designed to be knocked down.)
- No points will be awarded for an incorrectly driven obstacle. If the obstacle is incorrectly driven but not disturbed, it may be attempted again.
- If a horse should refuse or run out at an obstacle without disturbing it, the driver may elect not to attempt it and may drive to another obstacle without penalty. The obstacle may be attempted later. If it is correctly driven, the appropriate points will be recorded.
- A signal will sound at the end of the allowed time or when a break to a canter occurs and the driver must then exit through the Finish markers when the total time on the course will be recorded. (See Article C211).
- If the signal sounds when the competitor is committed to an obstacle, the competitor may complete the obstacle and receive the appropriate points, then proceed through the finish markers for total time to be recorded. Whether or not the competitor was committed to the last obstacle at the signal will be left to the discretion of the judge.
- Placings are determined on a high score basis. Time will decide ties. If a tie occurs in both points and time, the winner will be decided by a drive off.
- Penalties (See Article C246).

Dislodging a start or finish marker	5% of the total points accumulated
Break to canter will be penalized as follows (incident penalties are cumulative):	
1st incident .....	5% of total points accumulated
2nd incident .....	Additional 5% of total points accumulated
3rd incident .....	Additional 5% of total points accumulated
4th incident .....	Elimination

## ARTICLE C251 FAULT COMPETITIONS

### A. Cross Country Obstacles

1. To be driven over a prescribed course of natural and artificial obstacles designed to simulate those that might be encountered on a country drive (i.e., bridges, water, log pile, farm animal pens, etc.). Obstacles should be designed to be easily driven and are not to simulate Combined Driving Obstacles. Obstacles must be clearly numbered.
2. The suggested length of course is approximately 1 kilometer or .6 miles. Should the course design not allow judges to be able to see the entire course while judging, organizers may position spotters to observe and record course violations to be submitted to an event official for final scoring and spotters will also serve as observers for safety during this class. Spotters should be able to communicate with an event official during the class
3. After passing through the Start markers, the driver shall proceed through each obstacle, in order, keeping within the limits of the designated course markers and passing through the designated Finish markers.
  - a) Placings will be determined on a low fault basis (ie. those with fewer faults finish ahead of those with more faults).
  - b) Course faults and one fault for each commenced second over the Time Allowed are added together for a total score.
  - c) The Time Allowed is to be calculated as per Article C240
  - d) Time will decide ties for those with equal time fault totals.
4. Penalties

1	Exceeding time allowed per commenced second	1 fault
2	Knocking down or dislodging obstacle or course marker	4 faults
3	Break to canter (See Article C211) 1st break to canter ..... 2nd break to canter..... 3rd break to canter ..... 4th break to canter ..... Prolonged canter .....	5 faults 5 faults 5 faults Elimination Elimination
4	Disobedience or groom(s) dismounting anywhere on course (cumulative over course) 1st incident ..... 2nd incident ..... 3rd incident .....	3 faults 6 faults Elimination
5	Starting before signal	Elimination
6	Failure to cross starting line 1	Elimination
6	Failure to cross starting line within one minute of signal	Elimination
7	Exceeding time limit (2 x Time Allowed)	Elimination
8	Off-course	Elimination
9	Outside assistance	Elimination
10	Failure to carry whip (Article C207.2)	Elimination
11	Use of a tie-down or overcheck	Elimination
12	Breakage of harness or vehicle	Elimination
13	Entries that overturn	Elimination

14	Failure of entire entry to pass through start or finish markers	Elimination
----	---	-------------

## **B. Fault Obstacle**

1. To be driven over a prescribed course of numbered obstacles. The number of obstacles to be proportionate to the dimensions of the driving area. Not to exceed 20 obstacles.
2. As this class should be considered a test of precision driving, it is suggested that the obstacles be set at minimum allowances if the level of competition warrants.
3. After passing through the start line, the driver shall proceed through each obstacle in order and through the finish line.
4. Placings will be determined on a low fault basis (ie. Those with fewer faults finish ahead of those with more faults).
  - a) Course faults and one fault for each commenced second over the Time Allowed are added together for a total score.
  - b) The Time Allowed is to be calculated as per Article C240
  - c) Time will decide ties for those with equal fault totals.
5. Penalties are described in Article C250.A.4.

## **CHAPTER 8 – CLASS SPECIFICATIONS FOR PLEASURE DRIVES**

### **Section A – General rules**

#### **ARTICLE C252 GENERAL**

1. In any pleasure drive, all horse classes should start first followed by all pony classes.
2. On the course, repairs to the vehicle or harness may be made only by personnel actually riding on the vehicle. Outside assistance will incur elimination.
3. It is recommended that competitors be excused after completing the pleasure drive course and those awards be presented later in the show.
4. Dress should conform to Article C113 – *Dress of Driver and Passengers* and C207 - *Turnout* unless otherwise specified in the Prize List.
5. All rules of the road should be observed unless designated officials direct otherwise.

#### **ARTICLE C253 COURSE**

1. Pleasure drive courses must be carefully measured and the times accurately calculated.
2. All start and finish lines on the course must be clearly marked.
3. An accurate map indicating all pertinent course markings and directional changes and a listing of times allowed for each section must be made available to drivers prior to the opening of the course for inspection. A map and order of starting should be posted at least two hours before the start of the class.
4. Management has the choice of opening the course for inspection or running the pleasure drive “blind” (without course inspections). The option chosen must be clearly stated in the Prize List. If inspections are to be allowed, the times when the course will be open for inspection must be stated in the Prize List. No change in any part of a pleasure drive (course or time allowed) may be made after the posted inspection time without notifying every competitor.

5. It is recommended that Pleasure Drive course over 6 miles or 10 kilometers include a 5 to 10 minute rest stop.
6. A briefing meeting prior to the start is helpful to clarify any local conditions that might affect the competitor's performance.

#### **ARTICLE C254 TIMING**

1. The timing method must be clearly explained in the Prize List.
2. The course designer should take into consideration the terrain and road and path surfaces when calculating times allowed. It is the responsibility of the technical delegate to make adjustments when weather conditions dictate.
3. Suggested speeds are 8.7 mph (14 kph) for horses, 7.5 mph (12 kph) for Large ponies, 6.8 mph (11 kph) for Small ponies, and 5.6 mph (9 kph) for VSEs.

#### **ARTICLE C255 OBSERVERS ON COURSE**

1. The judge may, at his/her discretion, appoint assistants to be placed at strategic spots on the pleasure drive to officially observe and mark traffic or other course violations. Each observer's marked card must be submitted to the judge for final scoring.
2. In a walk section, official observers should be placed where the entire section may be easily seen in order to score breaks. It is recommended that there be a minimum of one observer for each 100 yard (91.44 m) increment. Each observer must submit a marked card for his/her assigned area recording the number of breaks of gait for each competitor.

#### **ARTICLE C256 SPARES AND APPOINTMENTS**

1. Spares must be carried on each vehicle during a pleasure drive. They are as follows:
 

-Wheel wrench to fit axle nuts	-Knife
-Length of rawhide, string or wire	-Leather punch
-Rein splice or spare rein	-Pliers
-Cooler or Quartersheet per horse	-Small hammer
-Trace splice or spare trace	-Hoofpick
-Halter and lead shank per horse	-Screwdriver
-Hames strap (if appropriate)	
2. One penalty point will be assessed for each item omitted. Complete omission of spares will receive 20 penalty points. Spares must be checked prior to the start of the pleasure drive. To insure that each vehicle actually carries the required spares, provision for random recheck at either the rest stop or immediately following the drive may be made (if explained in the Prize List).

#### **ARTICLE C257 PLEASURE DRIVE PARTICIPATION**

1. If scheduling permits, and except for courses that are to be driven without prior inspection:
  - a). A driver may compete more than once in a pleasure drive class.
  - b). A groom/passenger with one entry may compete as a driver with another entry.
  - c). A driver with one entry may compete as a groom/passenger with another entry.
2. Horses may not compete in more than one Pleasure Drive per competition day unless appropriate conditions exist and approval for all horses to do so is given by the Technical Delegate.

3. Grooms may not stand behind the driver. If the vehicle does not permit the groom to sit behind the driver, permission must be obtained to allow the groom to sit beside the driver..

### **ARTICLE C258 PLEASURE DRIVE PENALTIES**

Unless otherwise specified in class description, the following penalties apply to all Pleasure Drives. Additional penalties apply as per class descriptions.

1	Starting before the signal	Elimination
2	Failure to cross starting line	Elimination
3	Failure to cross starting line within one minute	Elimination
4	Off-course	Elimination
5	Exceeding time limit (2 x Time Allowed)	Elimination
6	Outside assistance (other than a navigator/groom indicating the route.)	
7	Failure to carry whip (Article C207.2)	Elimination
8	Use of a tie-down or overcheck	Elimination
9	Racing or otherwise endangering another vehicle or spectator	
10	Deviating from a direct route, stopping or walking to achieve correct times	Elimination
12	Entries that overturn	Elimination
13	Failure of entire entry to pass through start or finish markers	Elimination
14	Failure to complete the course	Elimination
15	Prolonged canter or gallop	Elimination
16	Spares: each item omitted	1 penalty point
17	Spares: completed omission	20 penalty points

### **Section B – Class Conditions**

#### **ARTICLE C259 PLEASURE DRIVE - TURNOUT**

Purpose: To give drivers the opportunity to turn out in their finest while competing in a pleasure drive.

1. Preliminary Judging: At the beginning of the class, drivers will be observed by the judge in a ring at a walk, slow trot, working trot and strong trot. Horses will be asked to halt and rein back. At the judge's discretion, entries need only work one direction of the ring.
2. Pleasure Drive Course: At the conclusion of the preliminary judging, each class will be sent out on course (order of go and timing to be at management's discretion). Drivers are encouraged to carry a groom/navigator who may assist in pointing out the route, but may not handle the reins, whip, or brake. The designated course may be of any length with no time limit. Care should be taken in designing the course to consider the antique vehicle and smooth tracks should be utilized when possible. The recommended gait is a trot, but the competitor may walk at his/her pleasure. Cantering is not permitted. Rules of the road must be obeyed, unless a uniformed police officer directs otherwise. Fitness may be checked at the conclusion of the drive by a veterinarian or, in the absence of a veterinarian, by the judge and may be considered accordingly.

3. **Final Judging:** At the conclusion of the pleasure drive, entries may again be observed by the judge in a ring. The judge may, at his/her discretion, ask entries to work only one direction of the ring. If the judge decides to work horses in one direction only in the Preliminary or Final phases of the class, it is recommended that they work one direction at the beginning of the class and the other direction at the end.
4. **Judging:**
  - 50% on overall impression
  - 50% on way of going, suitability of each entry as a pleasure to drive.

The following aspects will also be considered toward the overall impression:  
Horse - manners, way of going, condition, appropriateness and grooming.  
Harness - condition, appropriateness and cleanliness.  
Vehicle - condition, appropriateness and cleanliness.  
Driver - driving skills, posture, appropriateness and neatness of attire.
5. **Reasons for Elimination** – see Article C257.

#### **ARTICLE C260 PLEASURE DRIVE - TIMED**

**Purpose:** To allow the driver to compete against ideal time at both the walk and the trot. Simulated obstacles, not timed, may be added.

1. To be driven over a prescribed, measured course of any length (suggested length 3-6 miles or 5-10 kilometers), comprised of two sections, a trot section, followed by a walk section. Each section will be scored independently on a penalty point basis.
2. Time Allowed in the trot section shall be calculated from the distance and required speed. Minimum Time will be 2 minutes less than the time allowed.
3. A “Buffer Zone” must be placed between the finish of the trot section and the start of the walk section to allow for the change in gait. The recommended distance is approximately 50 meters (~50 yards).
4. The walk section of the timed pleasure drive should be 200-500 meters (200-500 yards) in length 400 meters (400 yards) recommended - 365.76 metres). Time Allowed in the walk section shall be calculated from the distance and required speed. Suggested speeds are 6 kph for horses, 5 kph for ponies. There is no Minimum Time in the walk section.
5. Obstacles may be added by management, however, it is encouraged that such obstacles be designed to promote safe driving while adding to the challenge of the event. Drivable opens in the obstacles should not be less than 8 feet 3 inches (2.5 meters) wide and “escape routes” are encouraged. A maximum of 4 obstacles is allowed.
6. Obstacles are considered part of the course and are not timed, but must be driven correctly or the driver will be eliminated. Up to 4 lettered gates (pair of red and white markers) should be placed in the obstacle to lead the driver through. Gates must be driven in consecutive order. Once driven, a gate is considered “dead” and may be driven in any manner to get to the next gate.
7. **Horse Inspection:** If a veterinarian is available for the cross country, he/she must be at the finish. All horses should be observed as they pass over the finish line. Whether or not a physical check is made is left up to the veterinarian and management, but if one is planned, all horses must be checked at the same time interval (i.e. 10 minutes after finishing). Competitors should be encouraged to cool their horses during this time. Management should provide water for drinking and washing down. Any horse that does not complete the course in good form, in the opinion of the veterinarian, will be penalized 10 points and so advised. In the absence of the veterinarian, the judge may assess the vet penalties for any horses in obvious distress.

8. Scoring:  
There is no penalty for arriving at the finish between the Minimum Time and Time Allowed.
  - 1 penalty per second under the Minimum Time.
  - 2 penalties per second over the Time Allowed.
  - 5 penalties for each break of gait as defined in Article C211 for 1st, 2nd, and 3rd breaks. The 4th break is elimination.
9. Ties: the judge shall determine the winner by selecting the horse most suitable to provide a pleasant drive. No entry which has received vet penalties may be placed over entries with no penalties.
10. Reasons for Elimination – See Article C257.

#### **ARTICLE C261 PLEASURE DRIVE - PACE**

Purpose: To test the driver on his/her skill in negotiating a cross country pleasure drive at a prescribed pace (similar to a hunter pace).

1. To be driven over a marked course of any length (suggested length 3-6 miles or 5-10 km). The mid-point of the course is marked with a “half-way” marker.
2. Drivers are given the distance of the course and the speed they are to drive and they must try to come to the finish line exactly on time.
3. Walk Section: Management has the option of adding a walk section near the midpoint, not to exceed 1 km. To be clearly marked with “walk” and “resume trot.”
4. Mandatory Trot: The last kilometer (.6 mile) must be driven at the trot. The start of the trot shall be marked “mandatory trot.”
5. One penalty is assessed for each second too early or too late. Five penalties for each break in gait as defined in Article C257.  
Walk Section and mandatory Trot Sections: 5 penalties for each break in gait as defined in Article C257 for 1st, 2nd and 3rd breaks, 4th break is Elimination
6. Horse Inspection: If a veterinarian is available for the cross country, he/she must be at the finish. All horses should be observed as they pass over the finish line. Whether or not a physical check is made is left up to the veterinarian and management, but if one is planned, all horses must be checked at the same time interval (i.e., 10 minutes after finishing). Competitors should be encouraged to cool their horses during this time. Management should provide water for drinking and washing down. Any horse that does not complete the course in good form, in the opinion of the veterinarian, will be penalized 10 points and so advised. In the absence of the veterinarian, the judge may assess the vet penalties for any horses in obvious distress.
7. Ties: In the event of a tie, the judge shall determine the winner by selecting the horse most suitable to provide a pleasant drive.
8. To be judged on: How close the driver’s time comes to the ideal time.
9. Reasons for Elimination – See Article C257.

*[Articles C262-266 reserved]*



## CHAPTER 9 – PUTTING-TO CLASSES

### Section A – General rules

#### **ARTICLE C267 INTRODUCTION**

This class is designed to test the skills and efficiency of the coaching team (driver, groom(s) and hostler). The conditions of the class simulate the custom of changing horses in a “yard”, but use only one horse or team of horses.

#### **ARTICLE C268 COURSE**

1. The class should be conducted in an enclosed area. There will be a start and finish line, an unhitching/hitching box.
2. The “unhitching/hitching box” is marked off with lime, chalk, sawdust or other appropriate material. The “box” must be large enough so that each type of entry competing in the class may stop the entire turnout within the enclosure.

#### **ARTICLE C269 TURNOUT**

Each turnout must comply with their entry type as specified below:

1. Four-in-Hand/Unicom - A driver, two grooms, a minimum of two passengers, one hostler to assist in the arena, four horses, and appropriate vehicle/harness.
2. Pair - A driver, one groom, a minimum of one passenger, one hostler to assist in the arena, the pair of horses and appropriate vehicle and harness.
3. Single or Tandem - A driver, one groom, one hostler to assist in the arena, the horse(s) and appropriate vehicle and harness.

The Hostler may not enter the arena until the vehicle is completely within the unhitching area.

### Section B – Class Conditions

#### **ARTICLE C270 BASIC FORMAT OF CLASS**

1. Upon entering the arena, the driver will drive through a set of starting markers, where timing will begin, and proceed to the unhitching area.
2. The entire turnout must be within the unhitching area, stopped, with grooms and passengers down before unhitching may begin. Passengers must dismount before the driver may leave the vehicle. The driver will dismount and remount from the off side.
3. The horses are unhitched by the driver, groom(s) and hostler.
4. After the horses are unhitched, the horse(s) must be led around the designated marker, brought back to the vehicle and rehitched properly to simulate changing teams.
5. When the horses are rehitched and the driver in place, the passengers and grooms remount and the turnout is driven across the finish line where time will be taken. Grooms may remount the vehicle as it moves off, but they must be seated as the coach crosses the finish line.
6. The driver is considered to be in place only after resuming his/her place on the box, properly attired, with lines and whip completely in hand.
7. Passengers may not assist in any way. They must dismount before any unhitching may begin and must remount only after the driver is in place.

8. Grooms must remain in complete livery when unhitching/rehitching.
9. The judge may inspect the turnout to be sure the horses have been rehitched properly.
10. The score is time elapsed plus penalties. The lowest score determines the placings.

**ARTICLE C271 SEQUENCE TO UNHITCH/HITCH -  
FOUR-IN-HAND UNICORN**

1. To Unhitch  
Leaders - inside traces, outside traces, then reins.  
Wheelers - loosen pole chains/straps, disconnect inside trace, out-side trace, pole chains/straps and then coupling reins.
2. To Hitch  
Wheelers – coupling reins, pole chains/straps loosely, outside traces, inside traces, then tighten pole chains/straps.  
Leaders - coupling reins, take reins back through terrets on wheelers, and then do outside traces and inside traces.

**ARTICLE C272 SEQUENCE TO UNHITCH/HITCH - PAIR**

1. To Unhitch  
Loosen pole chains/straps, disconnect inside trace, outside trace, pole chains/straps and then coupling reins.
2. To Hitch  
Coupling reins, pole chains/straps loosely, outside traces, inside traces, then tighten pole chains/straps.

**ARTICLE C273 SEQUENCE TO UNHITCH/HITCH - TANDEM**

1. To Unhitch  
Leader - Near trace, far trace, reins.  
Wheeler – Detach breeching, near trace, off trace, remove the horse from between the shafts, and then reins.
2. To Hitch  
Wheeler - Reins then place the horse between the shafts, attach near trace, off trace, then breeching.  
Leader - Reins, near trace and then far trace.

**ARTICLE C274 SEQUENCE TO UNHITCH /HITCH - SINGLE**

1. To Unhitch  
With reins attached to the bit and passed through the saddle terrets, detach breeching from each shaft, unfasten the overgirth or wrap straps, disconnect off trace, near trace, remove the vehicle from the horse.
2. To Hitch  
With reins attached to the bit and passed through the saddle terrets, bring the vehicle to the horse, placing the shafts through the tugs, attach near trace, off trace, fasten the overgirth or wrap straps and then breeching to the shafts.

**ARTICLE C275 PENALTIES**

1. Driver fails to remain seated with reins in hand until passengers have dismounted/remounted ..... 20 penalties
2. Outside assistance (other than the team of driver, 2 grooms, and hostler) ..... 20 penalties
3. Improper hitching/unhitching ..... 20 penalties
4. Unfastening any part of harness before vehicle is stopped and passengers are off ..... 10 penalties
5. Driver fails to carry a whip when vehicle moving ..... 10 penalties
6. Failure to pick up dragging trace/rein when leading horses ..... 10 penalties
7. Failure of grooms to be seated when crossing the finish line ..... 10 penalties
8. Failure to pass through start/finish or to go around designated cone ..... Elimination

**CHAPTER 10 – RULES FOR COACHING COMPETITIONS**

**Section A- General Rules**

**ARTICLE C276 GENERAL RULES**

1. This division for horse or pony four-in-hand teams put to a Road Coach, Private Coach or Park Drag or other suitable four-in-hand vehicles. Park Drags, Private Coaches and Road Coaches are not to be asked to back in any class.
2. The rules for competition are based on the old coaching traditions. More information on these turnouts is available in the following books: *On the Box Seat* by Tom Ryder; *Manual of Coaching* by Fairman Rogers; *Carriage Turnout and Appointments* by the Carriage Association of America and in Appendix 2-A – *Turnout and Appointments*.

**Section B – Class Specifications for Coaching**

**ARTICLE C277 CLASSES**

Classes may be offered in the following divisions: Open, Amateur, Working, Reinsmanship.

**ARTICLE C278 PLEASURE**

Entries to be judged both ways of the ring at an even trot, and may walk when reversing across the diagonal and when lining up. Horses to stand quietly. Judged on performance, quality, manners of the horses, and correct appointments. (See Appendix 2-A – *Turnout and Appointments*).

**ARTICLE C279 BEST TEAM**

Entries to drive at a smart trot, both directions of the ring. May walk when reversing across the diagonal and when lining up. Horses to stand quietly in the line-up. Emphasis on overall impression and quality of the team and its performance.

**ARTICLE C280 TURNOUT**

Entries to be shown at an even trot, both ways of the ring. May walk when reversing across the diagonal and when lining up. Horses to stand quietly in the line-up. Judged on performance, quality, manners of the horses, and correct appointments. (See Appendix 2-A *Turnout and Appointments*).

## Section C – Obstacle Driving

### ARTICLE C281 OBSTACLES

1. Drivers negotiate a course of paired markers (set at the widest track width plus 20 inches (50 cm)). The course should be posted at least two hours in advance and is driven from memory.
2. At the end of the course, the driver halts the team with his/her front hub on a line between a pair of designated markers. A measurement is taken of the distance of the hub from the line. Five faults are assessed for each foot (30 cm) or part thereof the center of the hub is from the line.
3. Two or more horses cantering at the same time will be considered a break in gait. Failure to correct a break in gait within 5 seconds will incur 10 faults for each commenced period of 5 seconds.

Faults are assessed as follows:

- a) Distance from halt marker ..... 5 faults/foot or part of ft (30 cm)
- b) Break in gait to canter or gallop  
exceeding 5 sec. ....5 faults/each comm. 5 sec
- c) Knocking down or dislodging obstacle or course  
marker 10 faults
- d) Groom down (first 2 times) .....20 faults/occurrence
- e) Groom down 3rd time.....Elimination
- f) Off-Course.....Elimination

### ARTICLE C282 TIMED OBSTACLES

To be judged over a course in the ring consisting of paired markers set 20 inches (50 cm) wider than the widest wheel track of each vehicle. The course is to be posted in advance and must be driven from memory, at a trot. Breaks of pace will be penalized as will displaced markers. Breaks of gait consist of the entire team walking or cantering for longer than 5 seconds.

Faults are assessed as follows:

- a) Displaced marker ..... 5 seconds
- b) Break of gait..... 10 seconds each commenced 5 seconds

## CHAPTER 11 – CONTINUOUS DRIVING

### Section A- Introduction and General Rules

#### ARTICLE C283 INTRODUCTION

The Continuous Driving Event (CD) consists of at least three driving competitions driven consecutively and separated by brief rest periods. Competitors may be divided in divisions by experience, age, gender, horse size, etc. Continuous Driving may be conducted in conjunction with other EC-sanctioned events unless specifically restricted by individual event rules.

#### ARTICLE C284 GENERAL RULES

1. A briefing meeting for competitors should be conducted by Officials prior to the start to clarify any local conditions and to answer questions.

2. The entry must be driven by the same person in all competitions unless otherwise specified by the organizer.
3. All rules of the road should be observed unless designated officials direct otherwise.
4. Spares are recommended but not required. Carrying a halter and lead rope on the vehicle is required.
5. Outside assistance, other than as specified by the rules, will incur elimination.
6. Entries eliminated from a competition are eligible to compete in the remaining competitions of the event.

#### **ARTICLE C285      OFFICIALS**

1. Judges must be EC and/or PTSO accredited in Pleasure Driving or Combined Driving or have an approved Guest Card, as shown in Appendix 1-A Event Summary Table.
2. A Technical Delegate is recommended with either a Pleasure Driving or Combined Driving licence and may judge Obstacle-Cones competition sections.
3. A Technical Delegate with either a Pleasure Driving or Combined Driving licence is required for events with 30 or more entries.
4. For events with fewer than 30 entries, a knowledgeable horseman may judge Obstacle-Cones competition sections.

### **Section B - Competition Conditions**

#### **ARTICLE C286      STARTING**

Each entry will be assigned a start time and will complete the competitions consecutively and in the order determined by the organizer. Rest periods of a few minutes should be allowed between each competition.

#### **ARTICLE C287      BOOTS**

Bell boots, shin boots, protective hoof boots and leg wraps may be used in all competitions at the discretion of the organizer as published in the Prize List.

#### **ARTICLE C288      ATTIRE**

1. Approved Protective headgear is required for all competitions. It is the responsibility of the competitor (or Parent or Guardian in the case of a junior competitor) to see that the headgear complies with the current safety standards and is in good condition and properly fitted and secured.
2. Attire should be the same for all competitions. Gloves and aprons/lap robes are required unless specified otherwise by the organizer as published in the Prize List.
3. Failure to carry a whip in hand while driving incurs elimination from a competition.
4. If Dressage is offered, a score will be given for presentation at the discretion of the organizer as published in the Prize List.

#### **ARTICLE C289      SCORING**

1. Unless specified by the organizer in the Prize List, the following scoring system must be used:

2. Each competition will be scored according to the EC driving rules for that competition and the entries placed accordingly.
3. Points for placings are as follows, 1st = 8; 2nd = 7; 3rd = 6; 4th = 5; 5th = 4; 6th = 3; 7th = 2; 8th = 1.
4. Points for each competition are combined for a winner in each division. (Highest point total wins.)
5. If an overall championship is awarded, the highest point total of all entries will be the Overall Event Winner.
6. For overall placing, entries eliminated in any ONE competition will finish below those who completed all competitions. Entries eliminated in any TWO competitions will finish below those who were eliminated in ONE competition, and so on.
7. Ties for each competition will be decided as specified in individual competition rules.
8. Ties for the overall event winner to be decided by the best score in the competition designated by the organizer as published in the Prize List

### **Section C – Competition Formats**

#### **ARTICLE C290            SUGGESTED FORMATS**

1. Option 1: Pleasure Drive – Pace (reference Article C260), a Driven Dressage Test, a second Pleasure Drive – Pace, followed by a Combined Driving Obstacles-Fault Competition (reference Article C976).
2. Option 2: A Driven Dressage Test, Pleasure Drive - Pace (reference Article C260), followed by a Combined Driving Obstacles-Fault Competition (reference Article C976.)

## APPENDICES

### APPENDIX 2-A – TURNOUT AND APPOINTMENTS

#### Section A - Attire

1. **Formal or Park** (Park Drag, Road Coach, Breaks, Mail Stanhope, Demi-Mail, Spider Phaetons, Stanhope or Park Gate Gig, George IV, Basket Phaetons, etc.)
  - a) Gentlemen to wear gloves a top hat or bowler, suit jacket and tie. Aprons should be of a solid colour material and harmonize with the upholstery. If the class is in the evening, gentlemen may choose to wear white or black tie.
  - b) Ladies to wear gloves, a stylish hat that may have a veil, long sleeved dress or blouse suitable for a formal affair. If the class is in the evening, ladies may opt not to wear a hat and may wear a formal gown.
  - c) Brown gloves are always appropriate for the driver unless rain gloves are needed.
  - d) Apron or lap robe should be of a solid colour material and harmonize with the upholstery (in warmer weather, tattersall or checked aprons are appropriate for day classes.)
  - e) Period costumes are not to be used, and conservative dress, appropriate to the style of the vehicle is encouraged.
2. **Sporting Vehicles** – Breaks, Four-Wheeled Dog Carts, Traps, Tandem Gig, Saylor Wagon, etc.).
  - a) Gentlemen to wear gloves, a bowler, boater, fedora, straw hat or cap, a suit or sport jacket and tie.
  - b) Ladies to wear gloves, a felt or straw hat (no veil), long sleeved dress or blouse suitable for a country outing.
  - c) Brown gloves are always appropriate for the driver.
  - d) Attendants to wear stable livery defined as:
    - i) Conservative suit, dark tie, derby, dark shoes and leather gloves
    - ii) Conservative jacket, jodphurs or drill trousers, jodphur boots or paddock boots, white shirt, stock or four-in-hand tie, derby or conservative cap and leather gloves.
    - iii) Hunting attire with a hunting derby or bowler and leather gloves.
  - e) Aprons may be of solid, checked or plaid material.
  - f) There are occasions when it may be appropriate for the driver to turn out more formally.
3. **INFORMAL OR COUNTRY** – (Village Cart, Two-Wheeled Dog Cart, Road or Jogging Cart, Four-Wheeled Buggy, Runabout, American Stanhope, Bronson Wagon, Surrey, Rockaway, etc.)
  - a) Attire and livery are the same as with a sporting vehicle.
4. **COMMERCIAL** – Attire should be traditionally correct for the type of commercial turnout.

## Section B – Vehicles

### 1. PARK DRAG OR PRIVATE COACH

- a) **DEFINITION:** A Park Drag should be of less heavy build than a Road Coach. The axles may be Mail or Collinges. The hind seat should be mounted on curved iron braces and be of the proper width for two grooms. The lazy-backs on the roof seats should be hinged and turned down when not in use. The door of the hind boot is often hinged at the bottom so that it may be used as a serving table when open. There should be no luggage rails or straps between the seats.

The driver may choose to have passengers on the Drag or Coach during coaching classes.

- b) **PAINT AND BODYWORK:** The paintwork should be well finished in traditional style. The sides of the front and rear boots, the upper quarters of the body, the steps and seat rails should be painted black. The under-carriage, the pole, the bars, the under side of the footboard and the seat-risers or cheeks should be painted the same colour; the lower panels of the body and the door of the rear boot may be painted the same or a different colour. A heraldic badge or monogram may be neatly painted on the crest panel of the door; on the rear boot door or on the underside of the footboard.

The outside seats may be trimmed in pigskin or wool broadcloth of a suitable colour with the underside of the cushions covered in waterproof material. The inside of the coach may be trimmed in Morocco leather or cloth or a combination of these materials. The inside floor may be covered with a Wilton carpet of solid colour. It is not usual to have seat-falls to the outside seats, but they may be fitted inside. The seat valances or borders of the outside seats may be made of patent leather fastened with a horizontal strip of bright metal beading of the same metal as the door handles and lock covers. The metal edging to the doors and hind boot should not be polished, but there should be bright metal on the seat-edge beading, door handles, and outer face of the hub caps. The glasses of the door windows should be plain and not quartered.

- c) **APPOINTMENTS:** There may be wine coolers and a glass case carried in the rear boot. A lunch chest or imperial may be carried on the roof but only when it is to be used as at a race meeting or similar occasion. Two spare lead bars, one side and one main, should be carried, and fastened to the back of the hind seat, with the main bar above. A folding iron ladder should be carried on brackets beneath the hind seat. The stick and umbrella basket is hung on the near-side, at the corner of the rear roof-seat, the drag shoe and safety hook should be hung under the coach on the off-side except in countries where they drive on the left of the road, in which case the drag is hung on the near-side. A spare jointed whip mounted on a board may be hung under the box-seat or inside the coach. The lamps may or may not be in their brackets in daylight hours, or may be carried in special fittings inside the coach. The window or stable shutters should be down and the windows in place when the owner or owner's representative is driving.

The coachman's apron when not in use should be folded outside out and laid on the driving cushion. Passengers' knee rugs or lap-ropes should be folded and laid on the front inside seat when not in use.

- d) **SPARES:** Spares may be carried in the rear boot or inside the coach. The usual: includes a small case of tools comprised of wrench, hammer, leather punch, screw driver, hoof pick, spare shoe and nails, or "Easy-boot," spare lead and wheel trace, spare lead and wheel rein or rein splicer, spare hame strap, length of strong cord or



wire. Loin or quarter rugs for the horses and halters should be carried in a convenient place.

- e) **HARNESS:** The harness should be of black leather with patent leather where appropriate. The harness should have solid draft eyes and kidney links with kidney link rings on the wheelers only. Bearing reins are permitted but should be on all the horses or none. A neat monogram or badge is permitted on the winkers, drops, pads, breastplate drops, and rosettes. The breastplates should be fastened round the collar as well as the kidney links for preference. Collars are not to be tied together. It is suggested that reins should be held in one hand, the other hand being able to assist as required.

The wheel traces should have metal loop ends or quick-release. The lead traces should be put on with screw heads of the cock-eyes uppermost, as also should be the lead-bar screws. Buxton bits are preferred and if bearing reins are used, they should be on all horses and be attached to separate bearing rein bits, not to the driving bit. Cruppers may be sewn or buckled on. The reins should be made of single brown leather. Appropriate straps should be lined and stitched. The bridles may have metal browbands on fronts, or they may be of other material to match the colour of the coach. Hame straps should be put on with the points inside. The metal furniture of the harness should be of the same metal as the buttons of the groom's coats and the door handles and beading of the coach. West End buckles are preferred.

The pole chains, the pole-head and the lead-bar hooks and mountings should be made of bright steel colour. The pole chains may have spring hooks at each end or may have open hooks with rubber securing rings at one end. Preferably the chains should be of a length that allows the snapping of both hooks into the pole-head ring. If too short, one end should be hooked into the pole-head ring and the other into a link with the snap down. If too long, one end should be snapped in the pole-head ring, snap down, and the other brought through that ring and snapped in a link at the appropriate length.

- f) **ATTENDANTS:** Two grooms in Livery should sit on the rear seat when the coach is moving, the senior groom on the right. When the coach is stopped, the senior groom stands by the right wheeler, able to take instructions from the driver, while the other groom stands at the leaders' heads.
- g) **HORSES:** Park Drag horses should be perfectly matched as to colour, size, style, action and temperament. They should be horses of quality but with sufficient substance to handle a loaded coach. Flashy coloring is not appropriate. They should have good manners, and should be capable of moving at a stylish trot with action but not excessively fast. They should stand quietly and move off together at a walk when asked to do so.

## **2. ROAD COACH**

- a) **DEFINITION:** A Road Coach is of stronger build than a Park Drag. The Coach may be finished as a Public or Private Road Coach, the latter carries no place names. The axles may be Mail or Collinges. The hind seat holds three persons besides the guard whose seat is on the near-side with an extra cushion. The lazy backs of the seats are usually not hinged. The guard should have a hand strap to take hold of when standing to sound the horn. There is a rail and luggage straps between the seats. The door of the rear boot is usually hinged on the off-side.
- b) **PAINT AND BODYWORK:** The distribution of black and colour in the paintwork follows the same pattern as a Park Drag, but the colours may be brighter. A Road Coach may have an appropriate name painted on the panel below the hind seat; a

figure or some device associated with the coach name may be painted on side and hind boot door panels. The names of places on the coach's route may be painted on the sides. If the wheels and other parts of the undercarriage are striped, it should be with a single broad stripe. The windows are usually quartered and the coach is driven with the stable shutters down. The outside seats may be trimmed in strong material such as coach carpet or Bedford cord, not leather. The inside of the coach is usually paneled in hardwood with seat cushions of drab cloth. The seat valances may be similar to the Park Drag or may be made of wood. The metal trim is similar to the Park Drag, except that the pole-head, lead-bar hooks and pole-chains may be painted black and not of bright steel.

- c) **APPOINTMENTS:** Two spare lead-bars, one side and one main, should be carried, fastened to the back of the hind seat with the main bar above. The folding ladder which may be made of wood is hung on brackets below the rear boot. The side lamps should be in their brackets, ready for use and a red rear light may be placed on a bracket below the rear seat on the near-side. It is usual for this lamp to have a clear lens on the right side so that it can illuminate inside the boot when the door is open. The stick and umbrella basket is hung on the near side at the corner of the rear roof-seat. The drag-shoe and safety hook should be hung under the coach on the off side. A spare jointed whip mounted on a board may be hung under the box seat or inside the coach. The coachman's driving apron and the passengers' rugs are carried also. Inside the coach there are leather pockets on the doors and leather hat straps on the roof.
- d) **SPARES:** These are the same as for the Park Drag and Private Coach, but the Road Coach may also carry a canvas bucket. Halters and loin or quarter rugs for the horses should be carried in a convenient place.
- e) **HARNESS:** The hardware of the harness should be of the same metal as the fittings of the coach. The harness is of black leather with most straps of single (unlined) leather. Collars may be of plain black or brown leather. Collars are not to be tied together. It is suggested that reins should be held in one hand, the other hand being able to assist as required. The hames should be of ring-draft type with short kidney links, chain and hook. Bearing reins are not usual but may be used on one or more horses if really necessary. The harness may be embellished with some symbolic device or the initial of the coach's name on the winkers, rosettes and pads. The wheel traces may have quick-release or French loop ends, and more rarely chain trace ends are used.
- f) **ATTENDANTS:** A Road Coach carries a guard who is usually dressed in a frock coat of appropriate colour, usually with strappings across the front and on the pocket flaps, breeches which may be white or of sponge-bag check, leather or canvas leggings, brown boots and a beaver hat. The guard carries a way-bill pouch slung over the shoulder with a pocket for a watch and a loop for the hind-boot key. He sits on the near side of the hind seat and his seat carries an extra cushion. The guard should have a hand strap to take hold of when standing to sound the horn. A groom in stable livery must also be carried.
- g) **HORSES:** Road Coach horses should be matched for size, weight, action, temperament, and way of going. They need not be matched perfectly for colour and flashy markings are not objectionable. They should be of sufficient weight to be able to pull the coach without appearing to labor at all. Although the wheelers may be the stronger horses, all the horses should be capable of working in the wheel. The horses should work evenly together all the time and be capable of moving at a good pace. They should stand quietly and move off together at the walk. It is acceptable for a

Road Coach team to have a grey near leader. Tradition holds that the colour would be more easily seen by oncoming traffic in the dark.

### **3. FOUR-IN-HAND BREAKS**

- a) **DEFINITION:** The Body or Wagonette Break, the Roof-Seat Break and an Omnibus with a roof-seat are vehicles in this category. All are classed as sporting vehicles.
- b) **PAINT AND BODYWORK:** The underside of the footboard, the rear boot door and the front seat risers may be painted in the same colour. The remainder of the body is usually painted black but the undercarriage may be painted in some bright colour. The seat cushions can be trimmed in Bedford cord, corduroy, leather or broadcloth. Seat falls are not usual. A stick basket, ladder if needed, spare bars and a spare jointed whip are carried. The side lamps are usually left in place ready for use.
- c) **SPARES:** Spares and other equipment are carried as for a coach and these are usually stowed in the rear boot.
- d) **HARNESS:** The harness is of a fairly simple kind without unnecessary embellishments. Breechings may be used on the wheelers if they are likely to be required. The wheel traces may have metal loops, French loops or quick-release ends. The hames may be solid draft with kidney links or ring-draft with short kidney links, chains and hooks. Liverpool or elbow bits are appropriate, except on formal occasions, with grooms in livery, when Buxton bits could be used.
- e) **APPOINTMENTS:** Sporting breaks are usually turned out informally with driver wearing country clothes and a bowler hat, the grooms in stable livery of trousers, jacket, shirt and tie with a bowler hat. However there are occasions when it may be appropriate for the driver to turn out more formally with a top hat and driving coat. The grooms could then wear livery. In such a case Buxton bits could be used.
- f) **HORSES:** The horses for a sporting break should be matched as to type and action. If they are matched as to colour, or “cross-matched,” that is diagonally matched as to colour, so much the better. They should move well together, be capable of a sustained active walk and a smart trot. They can be expected to rein back readily and to stand quietly. They should move off quietly and together, starting at a walk until asked to trot.

### **4. MAIL, STANHOPE, DEMI-MAIL, SPIDER GEORGE IV PHAETONS**

- a) **DEFINITION:** These vehicles are intended to be driven by the owner or a friend and are usually turned out in the more formal “park” style rather than in country style.
- b) **PAINT AND BODYWORK:** In all cases the body is usually painted black, except for the seat panel which may be finished in imitation cane or in a colour to match or blend with the colour of the undercarriage. The undercarriage may be painted in an appropriate bright colour and striped. The cushions may be covered in dark colored broadcloth with the seat back upholstered in black leather or, in the case of a Spider Phaeton without a top, in black patent leather. There may be a loose floor mat of heavy punched rubber over a floor covered with linoleum, or ribbed rubber may be laid on the floor boards. If there is a folding top, the valance may be of patent leather pinned in place with polished metal beading. The dash may have a folded waterproof apron attached or have leather loops for securing such an apron. A whip socket is usual. Lamps are of round dial pattern in most cases but show Spider Phaetons usually have square pattern lamps.

- c) SPARES: A small kit of tools, a wheel wrench and spare harness parts should be carried.
- d) APPOINTMENTS: A dashboard clock and waterproof coats are necessary.
- e) HARNESS: When it is possible to use a single horse with phaetons of this class, the harness has a bridle of square or D-shaped winkers; browband and rosettes of metal; Buxton bit; side-check bearing rein if any; Kay collar and hames with chain and ring coupling at the bottom; back-strap lined and stitched with crupper stitched on; breastplate; saddle of English pattern, 4 or 4-1/2 inches wide (10.16 or 11.43cm) with French or Tilbury tugs, reins of brown leather. Pair harness is similar in character with solid-draft hames with kidney links, short hame-tugs, straight panel pads, breastplates, trace bearers or loin straps optional, brown reins, bright steel pole chains. The hardware of the harness should be of the same metal as the polished metal parts of the vehicle. A Standing Martingale is required for a George IV Phaeton unless prohibited by individual class rules.
- f) ATTIRE: The driver usually wears a top hat, grey in the summer, black in the winter and in the evening indoors. A groom in livery occupies the rumble seat, but two grooms are considered proper with a Mail Phaeton.  
A Mail Phaeton may be turned out in country style with the wheel harness of a Road Coach and grooms in stable livery with Derby hats. The driver would then wear clothes of country style.
- g) HORSES: The horses used with these phaetons are upstanding horses of appropriate size for the vehicle, with high, stylish action, yet showing a good length of stride. They should be horses of quality with adequate substance. It is not usual to have the manes braided.

## **5. FOUR-WHEELED DOG CART, TRAP, OUTING WAGON**

- a). DEFINITION: These are informal vehicles of general utility. As such they may be painted to suit individual taste within the bounds of tradition and general practicality.
- b) HARNESS: The harness may have a bridle with D-shaped winkers, with or without side-check bearing rein; Liverpool or elbow bit; Kay or rim collar and hames; hames may have connecting chain at bottom of hame straps both top and bottom; saddle of English pattern with French or Tilbury tugs for four-spring vehicles, or a saddle similar to Surrey harness for three- or end-spring vehicles; breeching.  
Pair harness is similar, used with either trace bearers or breechings. Leather pole-straps are usual.
- c) ATTIRE: The driver wears country style clothes with a derby, felt or straw hat according to season and weather. The groom wears stable livery with a Derby hat.
- d) HORSES: The horse, or horses, usually stands 15.2 to 15.3 hands, has good all-round straight action, good head carriage and possesses adequate substance for the weight of the vehicle. Good manners are important and the horse should be capable of trotting at a smart pace.

## **6. STANHOPE OR PARK GATE GIG**

- a). **DEFINITION:** In North America these gigs were mostly used for show or park driving and were usually turned out in formal style.
- b). **PAINT AND BODYWORK:** They are painted to a high finish with black body, patent leather dash and fenders, with the dummy louvers on the Park Gate type or the seat back painted in colour. The undercarriage is painted in some quiet colour, tastefully striped. These gigs are never finished in natural wood.
- c). **HARNESS:** The harness has a bridle with square winkers, a gig or Buxton bit, sidecheck bearing rein, bridle fronts and rosettes of metal, Kay collar and well-fitted hames connected at the bottom with a chain and a ring. A breastplate or standing martingale is usual; the backstrap lined and stitched with the crupper sewn on; the saddle of English pattern with French or Tilbury tugs; a kicking strap is usually worn; brown driving reins. If the gig has a whiffletree, a breast collar of adequate size may be used.
- d). **SPARES AND APPOINTMENTS:** Small lamps of square pattern are usual and a small kit of tools and a wheel wrench should be carried. A dashboard clock and a whip socket are desirable.
- e). **HORSES:** A gig horse should be an attractive horse standing 15.1 to 15.2 hands, of good conformation and bold head carriage. He should be sharp moving with high stylish action with a good length of stride that allows him to cover the ground at a good pace.
- f). **ATTIRE:** The driver wears a grey top hat in the summer during daylight and a black top hat at other times. He wears an apron or knee rug. The groom wears dress livery.

## **7. VILLAGE CART, TWO-WHEELED DOG CART**

- a). **DEFINITION:** These carts are usually made to seat four people, back to back. There is an adjustable seat to achieve the proper balance and the driver should have an adjustable foot-rest. The balance should be adjusted to bring a small amount of weight on the horses back when the cart is loaded but not moving. The balance should NEVER be to the rear so that only the belly band prevents the cart from tipping up.
- b). **PAINT AND BODYWORK:** The body is usually painted black and the shafts, springs and wheels in colour and neatly striped.
- c). **HARNESS:** The harness has a bridle with D-shaped winkers, a noseband and a Liverpool or similar bit. A four-ringed or Wilson snaffle may also be used, but a Buxton bit is too dressy for such carts. The collar may be of Kay or rim design with hames connected at the bottom by a chain for preference. A false martingale or breastplate is usual. The saddle should be made on a tree with an inside channel through which the backband can slide freely. Open tugs are usual. The saddle should be well padded and 4-1/2 or 5 inches wide (11.43 or 12.7cm). The back-strap may have the crupper buckled or sewn on. A breeching or kicking strap is usual.
- d). **HORSES:** The horse should be well muscled, have good clean bone and be of the right size for the cart. He should have good manners with free striding, straight action.
- e). **ATTIRE:** The driver and passengers may dress informally and the groom, if one is carried, wearing stable livery.

## **8. ROAD OR JOGGING CART**

- a). **DEFINITION:** Light road carts are used for exercise and as personal conveyances. They may be painted to suit the individual's taste.
- b). **HARNESS:** The harness is similar to buggy harness and usually has a bridle with an overdraw check and a snaffle bit. A bridle with a normal noseband and a double-ring or Wilson snaffle or a Liverpool bit is acceptable and may be preferred by some judges. Although the saddle has little weight to carry, it should be well enough stuffed so that no weight bears directly on the horse's spine.
- c). **HORSES:** The usual road cart horse is of a fast trotting type.

## **9. FOUR-WHEELED BUGGY**

- a). **DEFINITION:** This is a vehicle of general utility.
- b). **PAINT AND BODYWORK:** The general style of painting was the body black and the running gear in some dark colour with or without striping.
- c). **HARNESS:** The harness should be of a simple kind with a bridle with square winkers, snaffle bit and overdraw check. A bridle with a noseband and a Wilson snaffle or a Liverpool bit is also quite appropriate. A breeching may or may not be used. Except for the heavier Goddard buggy, breast collars are usual.
- d). **HORSES:** The horse may be of trotting type, capable of moving at a good working trot. A pair may be driven to a buggy.

## **10. RUNABOUT, AMERICAN STANHOPE**

- a). **DEFINITION:** These small vehicles were popular at the turn of the century and may be considered as light phaetons.
- b). **PAINT AND BODYWORK:** Some were finished in natural wood; others were painted with a black body and undercarriage in sporting colours.
- c). **HARNESS:** The harness has a bridle with D-shaped winkers, noseband and a Liverpool or elbow bit, preferably no bearing rein. A breast collar is usual and a breastplate is optional. A breeching is also optional. The harness should be of good quality with most straps lined and stitched. Brown reins.
- d). **HORSES:** The horse should be a stylishly moving horse of great quality, able to trot at a smart pace. High action is not essential.

## **11. ROCKAWAY, DEPOT WAGON, CARRYALL, SURREY, CABRIOLET**

- a). **DEFINITION:** These are some of the types of family vehicles that were very popular throughout North America.
- b). **PAINT AND BODYWORK:** They were usually painted in sober style with the body black, the undercarriage in some fairly dark colour, tastefully striped. The cushions are usually covered in broadcloth of a colour matching the undercarriage, or in black leather. The dash and fenders, if any, are usually covered with patent leather. A Surrey may have a standing top with a fringe. Most are fitted with shafts or a drop pole that attaches to couplings on the front axle.
- c). **HARNESS:** The harness has a bridle with D-shaped winkers, bridle front of metal; side-check bearing rein or none at all; Liverpool or similar bit; collar of rim pattern with hames with chain connection at the bottom or with hame straps at top and

bottom; anchor or finger drafts; traces with slotted ends connected directly to the hames or to short hame tugs; saddle with straight or swell panels about 4 or 4 1/4 inches wide (10.16 or 10.70cm). Open or Tilbury tugs may be used and a breeching is normal. The harness straps may be lined and stitched or of single leather, the former preferred. A false martingale or breastplate is not essential.

Pair harness is similar in style with short hame tugs and trace loops on the pads. Trace bearers are usual.

A neck-yoke is used with a drop-pole, but if the pole is supported by a chain or strong spring, a crab pole-head and leather pole pieces may be used.

- d) HORSES: The horse (or horses) for a family vehicle should be 15.2 to 16 hands, with ample bone and weight for the work. High action is not wanted but a straight moving trot with a good length of stride and a regular active walk are what is needed. Good manners are essential.

## **12. COMMERCIAL VEHICLES**

a)DEFINITION: There is a wide variety of commercial vehicles used in the business of various trades. Each trade will have particular types and styles of vehicles, harness and horses suitable for that type of business.

b)PAINT AND BODYWORK: Vehicles are usually painted with signage indicating the proprietor, his location and the type of business and perhaps a business slogan.

c)HARNESS: The harness is well suited for the type of work and may also be decorated by the harness maker in order to attract attention and to be particularly memorable to the customers.

d)HORSES: The horse (or horses) for a commercial vehicle should be especially suited for the type of business. Commercial turnouts should be asked only for walk, slow and working trot and are expected to be able to back and stand quietly. Good manners are essential.

## **APPENDIX 2-B – PLEASURE DRIVING OFFICIALS REQUIREMENTS**

See Appendix 1A Event Summary Table for officials' requirements.

### **GUEST OFFICIALS** – see Article C610

**JUDGE INELIGIBILITY** - A judge may not judge an animal currently owned by or leased from the judge or an animal sold by said judge in a period of three months prior to the competition. A judge may not judge an animal that is boarded with or currently trained by the judge. A judge shall not judge a member of the official's immediate family, a person living under the same roof, nor a person with whom the official has a financial relationship. The judge may not judge anyone who has been instructed by that judge within a period of 30 days prior to the competition except for a group clinic.

**TD INELIGIBILITY** - A TD shall not be an competitor, judge (except as allowed by the rules), Driver, Course Designer, Organizer or Manager on the grounds where the competition is being held. A TD shall not officiate at any competition in which a member of his family, a person living under the same roof, a person with whom the judge has a financial relationship, clients or trainers are competing unless an emergency necessitates the replacement of the designated TD.



# PART THREE – DRAFT HORSE DRIVING COMPETITIONS

## CHAPTER 1 – DRAFT EQUINE RULES

### ARTICLE C301 GENERAL RULES

1. All EQUESTRIAN CANADA General Rules and Rules for Pleasure Driving apply except as specified below.
2. Draft equine are eligible for all EQUESTRIAN CANADA Pleasure classes provided they otherwise meet the class criteria.
3. Classes or divisions may be divided at the discretion of the Organizer as published in the Prize List.

### ARTICLE C302 THE HORSE

1. Type – The Draft Equine has the overall body, bone, and hoof that presents a larger, heavier structure and form than that of light horses or light ponies. The Draft-type equine should give the impression of size and substance combined with a pleasant and mannerly behavior with balanced and powerful movement at all gaits. Each horse should present a picture of soundness, strength, sturdiness and a willingness to work.
2. Gaits – as described under Article C211.  
**Exception:** Gaits may be limited to walk, slow trot, and working trot at the discretion of the Organizer as published in the Prize List.

### ARTICLE C303 TURNOUT

1. Harness - should be clean, safe; correctly fitting, appropriate to the vehicle and otherwise comply with Section C Rules.
  - a) A cavesson or full noseband, a throatlatch, and brakes or breeching are required
  - b) Check reins and martingales (except false martingales) are prohibited in Dressage and Obstacle classes. Failure to comply will incur elimination. For other classes, check reins and martingales may be appropriate turnout for certain vehicles. See Pleasure Driving Appendix.
  - c) Chain traces and heel chains are prohibited
  - d) A full neck collar, breast collar or Scotch collar may be used consistent with specific class conditions and the turnout as a whole.
  - e) Rein splitters are not allowed in obstacle classes
2. Vehicle - Any Pleasure Driving vehicle of suitable size and style for a Draft equine is allowed, such as, but not limited to, a wagonette, dog cart, country gig, or road cart. Individual class specifications may restrict certain vehicles. Unless specified in the class rules, farm type vehicles are not permitted. See the Pleasure Appendix for additional information on vehicles, appointments and turnouts
3. Feather, Mane and Tail - Draft equines may have thick, long feathering. Forelocks, manes and tails may be full and thick. Breeds may adhere to breed specific grooming/turnout practices with regard to trimming, roaching, braiding of manes and tails. No fixtures such as mane rolls or ribbons may be applied, except as specified in the Prize List.

**ARTICLE C304 DRESS**

1. Gloves and a hat (or approved protective headgear) are required. Aprons are recommended but optional. A whip should be carried in the hand or on the vehicle at all times while driving.

**ARTICLE C305 CLASS CONDITIONS**

1. Draft Equine classes may be the same as listed in the Pleasure Rules.
2. LADIES and JUNIORS: In classes for Ladies and Juniors, when applicable, emphasis should be placed on manners and the suitability for being driven by a lady or junior.
3. TANDEM: Lead horse tugs must be attached to the wheel horse's tugs behind the belly band or directly to the singletree. At no time shall lead tugs be attached to the hames of the wheel horse.

**ARTICLE C306 DRAFT HORSE OBSTACLES**

OBJECTIVE: The objective of this course is to drive a team through and around obstacles to simulate an actual farm situation.

1. An entry will consist of one teamster, one safety assistant, a team, and wagon of the same size and design (loaned or supplied if necessary).
2. Obstacles will include a gate; slalom course of pylons; a complete right and left hand circle; a square to stop the left front wheel in; a "barn" to back into; and coming to a precise stop on the finish line.
3. Accuracy is most important with time being used only as a tie-breaker.
4. Time in the course area will be restricted. If, in the Judge's opinion, a driver is spending an excessive amount of time at any obstacle, the teamster may be directed to move on to the next obstacle.
5. Time in the obstacle course starts when the center of the front wheels of the wagon cross the starting line.
6. Time stops when the teamster comes to a complete stop with the front wheels on the finish line.
7. The function of the safety assistant is to ride on the wagon and come to the aid of the teamster only if an emergency should arise. The assistant may not touch the lines or in any way speak or signal the teamster or team, or incur elimination.
8. Teams must walk or trot. Should a horse break into a lope and the teamster fails to rein them in, the entry will be eliminated.
9. Placing will be determined by the teamster with the highest points. Each teamster starts with 100 points.
10. In the event of a tie on points the teamster with the shortest time will win.
11. Penalties deducted:
  - a) Gate ..... 10 if any part of the gate is hit
  - b) Slalom..... 10 for hitting pylon or  
..... 10 if wheel is not within 3 feet of pylon
  - c) Left Circle..... 10 for hitting pylon or  
..... 10 if wheel is not within 4 feet of pylon
  - d) Right Circle ..... 10 for hitting pylon or  
..... 10 if wheel is not within 4 feet of pylon
  - e) Stop box ..... 10 left front wheel is not inside box  
..... 10 if wheel not stopped for 5 seconds
  - f) Barn ..... 15 if any part of the barn is hit
  - g) Stop line ..... 10 if front wheels do not stop on line

h) Off-course .. .....20 if there is a deviation from course.

**ARTICLE C307      OBSTACLE COURSE**

Enter the gate (timing starts when front axle crosses start line), drive to the left and perform the slalom, with a front wheel inside the barrier rings around each cone placed. Continue clockwise to the Figure of 8, a front wheel inside the ring, and travel each circle to cross own wheel tracks. Continue to the stop box and place left front wheel inside, not turning for 5 seconds. Next proceed to simulated barn, backing in, turning if necessary until the front axle of the wagon is inside.

The last obstacle is to be missed with the front wheels and straddled by the rear wheels. Timing stops with the front wheels stopped on the finish line.

# APPENDICES

## APPENDIX 3-A – SAMPLE OBSTACLE FOR DRAFT HORSE COMPETITIONS

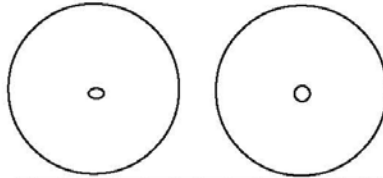

#2 - Figure 8 - 24 feet between cones, 4 foot barrier rings.

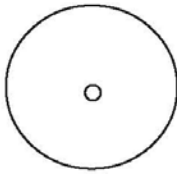

#3 Stop box - 18 inch square for left front wagon wheel.

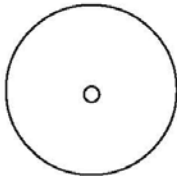

#1 slalom - 24 feet between cones, 3 foot barrier rings.

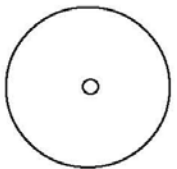

#4 Barn - back into "L" until front wheel are inside.

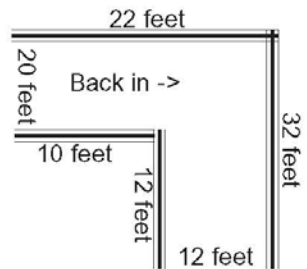

#5 obstacle



Start ○

○ Finish ○

# **PART FOUR – RECREATIONAL DRIVING COMPETITIONS**

## **CHAPTER 1 - TREC**

### **ARTICLE C401 OVERVIEW**

Technique de Randonnée Equestre de Compétition (TREC) originated for riders in France in the 1970s and was developed for driving by the British Driving Society a few years ago. TREC driving is presented with the cooperation and permission of the TREC Equestrian Association of BC. This is a very informal competition, ideal for the recreational driver offering a few similarities to Pleasure Driving obstacle-games and Combined Driving marathon and obstacle-cones competitions, but the formality, dress codes, volumes of pre-event information, regulation and volunteer requirements are greatly reduced.

The following articles describe the competition and are general guidelines that may be modified as necessary by the Organizer or person in charge. Safety, welfare of animals, and fairness must be maintained in a friendly atmosphere allowing good horsemanship and sportsmanship to prevail. Improvements and constructive comments are welcome and should be forwarded to Equestrian Canada.

### **ARTICLE C402 PRE-EVENT**

1. Basic planning considerations:
  - a) A suitable area to be located that must have sufficient parking and maneuvering room for participants' trucks, trailers, and horses as well as an area to put to and exercise prior to the event. The cross-country course may vary from approximately 5 km – 12 km; and an area with suitable footing is required for about 10 skill demonstrations laid out along a track up to 2 km.
  - b) Advertising must include an entry form stating the date, entry deadline, costs, and a general description of the terrain, footing and distances to be driven. The meeting time, detailed location directions, provisions for lunch and contact number for additional information.
  - c) A qualified individual in First Aid or an EMT and/or arrange for reasonable response time ambulance services. Contact information for a local veterinarian and farrier should be available.
  - d) A general meeting area, place for obtaining orientation and map briefings, viewing scores, and toilets to be available.
  - e) One or more routes for Part 2 - Cross-country considering level of drivers, terrain, footing and anticipated weather conditions are required.
  - f) One large-scale Master Map of the intended route to be posted at the driver orientation for viewing and note taking. Copies are not distributed to the participants.
2. Competitors are required to: complete an entry form; provide evidence of insurance; sign a liability release; pay required fees and provide a general description of driving experience.

### **ARTICLE C403 ARRIVAL**

1. Directions or assistance to parking, unloading, harnessing, putting to and exercise areas to be provided.
2. A suitable area for registration, general meeting, driver orientation and refreshments to be available.
3. An order of go for each Part to be posted in the meeting or arrival area is required.
4. Drivers must complete registration, receive a turnout number and map for the Orientation to be used in Part 2 – Cross-country drive

### **ARTICLE C404 ORIENTATION**

1. An informal introductory meeting to explain the day's activities; outline any important restrictions and general information; and answer questions is held following arrival, registration and before any competitions.
2. Drivers may view and record whatever information they may deem appropriate from the Master Map following the orientation. Signage on the route is minimal. Only the mandatory walk section start and end is required to be marked. Any additional signs will be indicated on the Master Map.
3. An "ideal time" for Part 1 – Cross-country is posted or announced for each of the available routes. The total distance is measured from start to finish marker. A mandatory walk section between 500 and 1,000 metres is included within each route. Drivers will be given the pace required based on equine size. The Ideal Time will be calculated on combining the total distance for trot at trot speed plus walk distance at walk speed.
4. Suggested maximum speeds based on experience of drivers and conditioning of equines, adjusted for terrain; footing; weather conditions:  
Horses; 14 kph; ponies 13 kph; small ponies 12 kph; Draft horses 10 kph; VSEs 9 kph.
5. There is no inspection of the cross-country by competitors prior to Part 2.
6. A course walk along the track for Part 3 is conducted to explain the purpose and requirements for each of the skill demonstrations.
7. Each driver starts with a score of 50 points.

### **ARTICLE C405 PART 1 – SAFETY CHECK**

1. A Safety Officer will review each turnout and may require any unsafe harness, hitching or vehicles to be corrected prior to starting. There is a list of specified spares to be carried throughout the event. It is recommended that each driver complete a Safety Checklist similar to Appendix 1-B.
2. Required items: 2 points are deducted for each item not present or not in good repair:
  - a) Spare halter and lead line for each horse
  - b) Spare rein or rein splice and hole punch
  - c) Spare trace or trace splice and hole punch
  - d) Spare hames strap if full collar is used
  - e) Signaling device for emergencies
  - f) SMV sign properly installed
  - g) Reflective vest or raingear (must be worn by driver and groom(s))
  - h) Human First Aid kit
  - i) Equine First Aid kit
  - j) Hoof pick

- k) Quick release trace, shaft loop and back strap connectors or knife
3. One point is awarded for additional personal choice safety-related items such as.
    - a) Length of rawhide or chord
    - b) Duct tape or bailing wire
    - c) Reflective tape on vehicle/harness for increased visibility
    - d) Easy boot and/or tool for removing loose shoes.
  4. Any vehicle or harness deemed “unsafe” or inappropriate for conditions will not be allowed to continue.

**ARTICLE C406 PART 2 – CROSS-COUNTRY DRIVE**

1. Drivers must have completed Part 1 prior to starting. Consecutive starts should be 4 minutes apart with spacing between different horse size groups. Starts may be 3 minutes apart if sufficient passing room is available throughout the course.
2. Two courses may be offered simultaneously from the same starting position – one relatively easy for novice drivers/horses; and a second with more challenge for the more experienced horse/drivers. The determining factors for the course choice may be made jointly by the organizer and competitor.
3. Drivers must pace their horses appropriately to arrive at the Ideal Time. One point is taken for each whole minute under or over the Ideal Time.
4. Horses must trot from the “Trot only” sign for the last 200 metres.

**ARTICLE C407 PART 3 – SKILLS DEMONSTRATION**

1. A number of skills demonstration areas are provided over a short course of about 1500 meters.
2. A volunteer observer is required at each skill positions to award points.
3. Points range from 1 to 10 for each skill position based on pre-determined requirements given to each driver at the orientation.
4. Drivers are timed between the start and finish line (same location) and must attempt the required skill at each skill demonstration area. Drivers are spaced approximately 2 skill areas apart to void hold ups.
5. A predetermined Time Allowed with a wide window, giving consideration to reduced pace or time taken at each of the skill demonstration areas. The object is only penalizing drivers who are excessively slow in completing this course and for unnecessary speed. One point deducted for each commenced minute outside the Time Allowed window.
6. Suggested skills (to be creative and imaginary; respecting safety, animal welfare, drivers’ experience and local conditions:
  - a) Driving a serpentine, penalties for knocking markers or paces other than a trot
  - b) Picking a flag from one cone and putting it in another; penalties for stopping, dropping the flag, failing to remove or replace the flag.
  - c) Halting in a square for 10 seconds; penalty for horse not remaining immobile or less than ten seconds
  - d) Driving a figure or shape defined by rails laying on the ground; penalties for horse or wheels touching the rails, pace other than a trot
  - e) Driving with left wheel(s) through a pair of rails spaced 15-20 cm apart; penalties for touching rails.

- f) Backing three paces; penalties for disobedience, horse not backing willingly or rearing
- g) Ascend or descend a short hill; penalties for disobedience
- h) Drive through a water splash; penalties for disobedience
- i) Passing through a lettered obstacle; penalties for improper order, contacting elements with horse or vehicle; pace other than trot
- j) Straddling a 20m circle with your wheels; penalty for each time a wheel crosses the line, for break to pace other than a trot.

**ARTICLE C408 SCORING**

1. Drivers may be grouped depending upon entries. Suggestions:
  - a) Experience: “Novice”, “Done it before”, “Previous winner” or other fun ways to give everyone a chance to be a winner.
  - b) Horses, ponies, VSE. For small numbers – for limited entries, Times Allowed in Part 2 allow all sizes to compete together
  - c) Groups competing on different routes in Part 2 – optional as results are comparable
  - d) Skill demonstrations – any group may not be required to drive every skill (group experience level determined by Organizer).
2. Points from each of part of the event are added together.  
 Each Driver starts with 50 points  
 Part 1: - 2 points for each listed item in good repair  
           + 1 point for each additional item (Safety Inspector’s discretion)  
 Part 2: - 1 point for each commenced minute early or late to Ideal Time.  
 Part 3: add 1 – 10 points for each skill demonstration according to schedule  
           - 1 point for each commenced minute over/under Time Allowed.
3. The driver with the highest total points wins
4. Sample score sheet:

**DRIVING RALLY RESULTS**

Driver →	1	2	3	4	5	6	7	8	9
Start	50	50	50	50	50	50	50	50	50
Part 1 – Safety	±								
Part 2 – Drive	-								
Part 3 – Skill 1	+								
Skill 2 +									
Skill 3 +									
Skill 4 +									
Skill 5 +									
Skill 6 +									
Skill 7 +									
Skill 8 +									
Skill 9 +									
Skill 10+									
T/A -									
<b>Total</b>									
<b>Place</b>									



## CHAPTER 2 – COUNTRY HERITAGE

### ARTICLE C409 OVERVIEW

A Country Heritage can be any organized driving activity containing elements of a competition where the public is invited to participate; there is a system of scoring involved, and there are placings, with or without ribbons or prizes.

The following articles describe the competition and are general guidelines that may be modified as necessary by the Organizer and person in charge. Safety, welfare of animals, and fairness must be maintained in a friendly atmosphere allowing good horsemanship and sportsmanship to prevail. Improvements and constructive comments are welcome and should be forwarded to Equestrian Canada.

### ARTICLE C410 GENERAL

1. Purpose is to preserve and celebrate our heritage in the use of horses and vehicle, demonstrating good horsemanship, driving skills, the care and preservation of harness and vehicles, and the intangible qualities of good sportsmanship.
2. Entries may be classified by turnout groups.
3. Grooms (capable of rendering assistance) and passengers are encouraged to participate: one groom for Single, Pair and tandem turnouts, 2 grooms for unicorn and four-in-hand turnouts. VSEs require one groom only for turnouts with more than one horse.
4. There are 3 parts: a Turnout Inspection; a Country Drive; and a Cones Course.
5. Horses may be of any breed or size, in suitable condition.
6. Harness must be in good condition, well fitted, and suitable for the vehicle being used. Leather harness is preferred over synthetic.
7. Vehicles must be in good repair. Antique or traditional reproductions are preferred over pure marathon styles.
8. Style of driving – English classical, Achenbach, Hungarian or North American are all acceptable however should be complimentary to the turnout. Driver must carry a whip in hand whenever the vehicle is not stationary.
9. Each turnout competes against ideal rather than other entries.
10. The optimum score is 100 points: with 50 possible for the Turnout Inspection; 25 for the Country Drive; and 25 for the Cones Course.
11. Awards are at the option of the Organizer, one winner per class is common.

### ARTICLE C411 TURNOUT INSPECTION

1. Each turnout competes against an ideal rather than with other entries, Ideal turnout specifications are published in Part II, Appendix A- Turnouts and Appointments.
2. No boots or bandages are allowed during Turnout Inspection.
3. Turnouts are judged by one, two or three knowledgeable judges:
  - a) At the halt - quality, cleanliness, safety and general impression of the horse(s), driver, passenger(s) and groom(s). Harness must be in good condition, well fitted, and suitable for the size and style of the vehicle. Vehicles must clean and in good repair. Dress for driver and passengers all to be consistent with style of vehicle; park or town turnouts in town attire; country turnouts in country attire. Grooms dress to be as a family member or consistent with turnout.
  - b) In motion – overall impression, way of going, style of driving, horsemanship, reinsmanship and obedience.

4. Points are awarded by each judge in five categories: Horses/ponies; harness; vehicle; driver/groom/passengers; and general impression. Points range from 1-10, with a 10 being “exemplary quality” to a 1 being “extremely poor”.
5. The total points (maximum 50) are the score for the Turnout Inspection. If more than one judge, the total points are average for the score.

#### **ARTICLE C412 COUNTRY DRIVE**

Object is to allow competitors to demonstrate their ability to drive safely in a variety of conditions and situations.

1. A route between 5 and 10 kilometres, suitable for all participating turnouts should be used, considering terrain, footing and weather.
2. Rules of the Road and common courtesy must be observed.
3. Anyone driving recklessly or unsafely will be asked to leave.
4. Gait is at the discretion of the driver taking into consideration the terrain, footing, weather conditions and condition of the horse(s)
5. A Time Allowed will be established by the Organizer based on the distance and average pace with a window of 2 to 4 minutes.
6. Suggested maximum speeds:  
Horses – 14 kph; Ponies 13 kph; Small ponies 12 kph; VSEs Donkeys and Heavy Horses 9 kph; Coaches 11 kph.
7. The route shall be flagged with mandatory gates to assist in maintaining the route and prevent short-cuts. Gates shall be a minimum of 3 metres wide, with a red marker on the right and a white on the left. One or both markers may be numbered, or a separate number posted below the red marker.
8. The route may include up to five simple Drivers’ Tests, either man-made or natural, and be completed in the overall time allowed.
9. Drivers’ Tests must not be hazardous in any way and be a minimum of 3 metres wide.
10. Each Driver’s Test will require a volunteer observer to record the results for each entry.
11. Examples of Drivers’ Tests:
  - a) Demonstrating appropriate road signals
  - b) Signaling and executing a turn
  - c) Executing a whip proper whip salute
  - d) Reinback a specified number of steps
  - e) Drive over a bridge
  - f) Drive up to a red carpet, halt, take up or let off a passenger
  - g) Drive up to a gate, stop, and put a groom down. Groom opens gate, turnout drives through and stops, groom closes gate and remounts vehicle.
  - h) Demonstrate a simulated repair to some part of the vehicle
  - i) Drive a figure of 8 indicated by cones
  - j) Drive up to a mail box and remove or deposit a letter.
12. Scoring the Country Drive – drivers start with the maximum of 25 points, then deduct the following (to a maximum of 25 points):
  - a) 2 points for each incomplete or unsuccessful Drivers’ Test
  - b) 5 points for not completing the Country Drive within the Time Allowed window.
  - c) 5 points for not passing through a mandatory course gate.

## **ARTICLE C413 CONES COURSE**

Purpose is to allow drivers to demonstrate their abilities to drive through a set course of cone pairs and to demonstrate the training and obedience of their horse(s).

1. It is recommended the Cones Course follow the Country Drive, however with limited space or time, the course can be incorporated into the Country Drive.
2. The course is to be driven at the trot. Reckless or unsafe driving must be halted and the driver asked to leave.
3. Organizers will determine the length and Time Allowed on course and order of go. This information and a map of the course must be posted at least 2 hours before the Country Drive.
4. A Time Allowed will be calculated based on the distance between start and finish cone pairs at a speed taking into consideration the course, footing, weather conditions, conditioning of equines, The following are suggested maximum speeds:  
Horses 180-230 mpm; Ponies and VSEs 150-215 mpm; Coaches 135-180 mpm; Heavy Horses 110-150 mpm; Donkeys 85-135 mpm.
5. A warm-up area of similar size and footing is recommended with a couple of cone pairs for practice.
6. The course design may have between 5 and 10 gates, with the start and finish being the first and last. The sequence may be numbered on or adjacent to the cones.
7. A gate is a cone pair, marked red on the driver's right and white on the driver's left, each with a dislodgeable ball on top
8. Clearance between cone pairs is based on individual vehicles wheel widths measured on the ground to the outside of the rear wheels. This may be done at the Turnout Inspection.
9. Recommended clearance is the vehicle wheel width plus: 50 cm for two wheeled and short four-wheeled vehicles; 60 cm for four-wheeled vehicles longer than 180 cm between front and rear axles. Three abreast turnouts should be a minimum of 210 cm.
10. Drivers shall enter the area, salute the judge and proceed after the bell is rung.
11. The judge may ring the bell if the course becomes unsafe or there is a noticeable safety issue with the turnout whereupon the driver must come to an immediate halt for further direction.
12. Time will be stopped or adjusted and the driver may proceed at the judge's discretion.
13. Scoring the Cones Course – drivers start with the maximum of 25 points, then deduct the following (to a maximum of 25 points):
  - a) 2 points for dislodging a ball
  - b) 2 point for cantering (each occurrence)
  - c) 5 points for exceeding the Time Allowed
  - d) 5 points for repairable equipment breakage
  - e) 10 points for taking a pair of cones out of order
  - f) 10 point for missing a pair of cones.

## **ARTICLE C414 SCORING**

1. There may be a prize for the winner of each competition, or one prize for the highest points for all three competitions combined.
2. Total points are calculated as follows:
  - a) Turnout Inspection – total points received by each entry (or average if more than one judge); plus.
  - b) Country Drive – point total (cannot be negative); plus
  - c) Cones Course – point total (cannot be negative).
3. The driver with the highest total points wins

## **CHAPTER 3 – SLEIGH RALLIES**

### **ARTICLE C415 INTRODUCTION**

The Sleigh Rally (SR) is an event consisting of various Pleasure Driving competitions, conforming to Equestrian Canada driving rules and conducted with sleighs on snow.

### **ARTICLE C416 GENERAL RULES**

1. Unless otherwise specified, and whenever possible, sleigh rally classes should conform to existing class rules for Pleasure Driving.
2. Obstacle classes:
  - a) Vehicle clearances for all obstacles classes should be set at a minimum of two meters.
  - b) Courses should be set with wide, flowing turns to accommodate the larger turning radius required by sleighs.
3. Entries must not be asked to rein back in any class.
4. Canterng is not allowed.
5. A Technical Delegate is recommended but not required.
6. Extra care should be taken to maintain safe conditions due to limitations placed on horses, competitors, assistants, volunteers and spectators from low temperatures, bulky clothing, and slippery or deep footing.

### **ARTICLE C417 CURRIER AND IVES**

The class may be judged: (a) as a separate class, or (b) by overall impression throughout the competition. The judging method must be clearly explained in the Prize List.

1. The entry fee for the class remains the option of the management. However, if the class is judged on an overall impression throughout the competition, it is recommended that no class fee be charged and all participants be eligible.
2. The essence of the competition is the presentation of the classic winter turnout in the late 19th and early 20th century as notably depicted by Currier & Ives. The top placings will be the turnouts which best capture this effect. This will include vehicle, harness, appointments, horse(s), driver, passengers, grooms, etc., but above all, general impression is most important. Vehicle and harness may be inspected to ensure thoughtful restoration (where antiques are used) and careful maintenance. Attention will be paid to the personal appearance of the driver, grooms, and passengers as it contributes to the overall picture. Performance will not be judged unless it detracts from the elegance of the turnout.

## **PART FIVE –DRIVEN DRESSAGE COMPETITIONS**

*The Articles in this section apply to stand-alone Driven Dressage competitions or classes held in conjunction with a Pleasure Driving Show. Whenever a Driven Dressage competition is held in conjunction with an Arena Trial, Driving Trial or Combined Driving Event, the rules for Driven Dressage in Part Nine, under Chapter II - Driven Dressage must be used.*

*General Regulations, (Chapters 1 through 8) apply to Driven Dressage competitions unless superseded by rules in this Part Five – Driven Dressage Driving Competitions.*

### **CHAPTER 1 – GOVERNING REGULATIONS**

#### **ARTICLE C501 OBJECT OF DRIVEN DRESSAGE**

1. The object of Dressage is the harmonious development of the physique and ability of the horse. Through progressive training the horse becomes calm, supple, and flexible as well as confident, attentive and keen in his work.
2. These qualities are revealed by:
  - a) The freedom and regularity of the paces;
  - b) The harmony, lightness and ease of movement;
  - c) The lightness of the forehand and the engagement of the hindquarters, originating in a lively impulsion;
  - d) The acceptance of the bridle, without any tenseness or resistance.
3. The horse, confident and attentive, submits generously to the driver, remaining straight in any movement on a straight line and bending accordingly when moving on curved lines.
4. His walk is regular, free and unconstrained. His trot is free, supple, regular, sustained and active.
5. Because the horse has impulsion and is free from resistance he will obey without hesitation and respond to the various aids calmly and with precision, displaying a natural and harmonious balance both physically and mentally.
6. In all his work, even at the halt, the horse should be 'on the bit'. A horse is said to be 'on the bit' when the hocks are correctly placed, the neck is more or less raised and arched according to the stage of training and the extension or collection of the pace, and he accepts the bridle with a light and soft contact and submissiveness throughout. The head should remain in a steady position, as a rule slightly in front of the vertical, with a supple poll as the highest point of the neck, and no resistance should be offered to the driver.

### **CHAPTER 2 – MOVEMENTS**

#### **ARTICLE C502 THE HALT**

At the halt, the horse should stand attentive, motionless and straight, with the weight evenly distributed over all four legs if a multiple, all must be square and aligned with one another. The horse may quietly champ the bit, while maintaining a light contact with the driver's hand, and should be ready to move off at the slightest indication.

The halt is obtained by the displacement of the horse's weight on the quarters by properly used aids, driving the horse forward toward a restraining but allowing hand, causing an almost instantaneous but not abrupt halt from the previously fixed pace.

### **ARTICLE C503 WALK**

The walk is a marching pace in which the footfalls of the horse's feet follow one another in four-beat time, well-marked and maintained in all work at the walk.

When the four beats cease to be distinctly marked, even and regular, the walk is disunited or broken.

It is at the pace of the walk that imperfections in progressive training are most evident.

The following walks are recognized: Free walk on a long rein, working walk, lengthened walk.

1. **FREE WALK:** The free walk is a pace of relaxation in which the horse is allowed the freedom to lower and stretch out his head and neck to the utmost. The reins must be long enough to allow for this stretch, however, they should not be loose enough to loop. It is desirable that the hind feet touch the ground clearly in front of the foot prints of the fore feet (over tracking).
2. **WORKING WALK:** A regular and unconstrained walk. The horse should walk energetically but calmly with even and determined steps with distinct, marked, four equally spaced beats. The driver should maintain a light and steady contact with the horse's mouth ("on the bit"). The horse's hind feet should at least step into the prints of the forefeet.
3. **LENGTHENED WALK:** This a more determined and ground-covering walk than the working walk. The main difference between the free walk and the lengthened walk is that the driver now actively asks the horse to produce more push from behind and thus lengthen his stride. The horse must flex his poll somewhat and is expected to work into the bit on a soft contact. The horse should not stretch as long and as low as in the free walk, but has to show a definite lengthening and lowering of the frame compared to the working walk. Some overtrack is expected.

### **ARTICLE C504 TROT**

The trot is a pace of two-time on alternate diagonal legs (near fore and off hind leg and vice versa) separated by a moment of suspension.

The trot, always with free, active and regular steps, should be moved into without hesitation.

The quality of the trot is judged by the general impression, the regularity and elasticity of the steps – originated from a supple back and well engaged hindquarters — and by the ability to maintain the same rhythm and natural balance.

The following trots are recognized: Collected trot, Working trot, Lengthen stride in the trot, and Extended trot.

1. **COLLECTED TROT:** In the collected trot the horse is expected to move with more impulsion and engagement than in the working trot. Therefore his haunches must be more compressed, his loins more strongly coiled and his croup lowered. As a result the horse's neck and head will be raised higher and his center of balance will be shifted permanently more toward the rear, thus enabling the shoulders to move with greater ease and freedom with the poll the highest point. The nose should not be over bent or the neck restricted. As the horse's frame is shorter than in other trots, his steps will also be shorter but must be more elevated, and he appears lighter and more mobile

throughout. Hollowing and/or stiffening the back are severe faults. Only a moderate degree of collection should be expected from a driving horse.

2. **WORKING TROT:** A regular and unconstrained trot, in which a horse, even if not yet trained and ready for collected movements, shows himself properly balanced and remaining on the bit, goes forward with even elastic steps and good hock action. The expression “good hock action” means here a free and energetic forward swing of the hind legs with hocks brought well forward underneath the horse’s body, aiding in his free forward movement.
3. **LENGTHEN STRIDE IN THE TROT:** This trot is used as a preparation for the extended trot. While maintaining the same rhythm, the horse covers more ground than in the working trot. He must lengthen and lower the frame and stride while remaining on contact.
4. **EXTENDED TROT:** The horse covers as much ground as possible. Maintaining the same rhythm, he lengthens his step to the utmost as a result of great impulsion from the hindquarters. The driver allows the horse, remaining on the bit to lower and extend his neck in order to prevent his action from becoming higher.

#### **ARTICLE C505 WORKING CANTER**

A forward, active pace with regular steps of three-time pace, the horse showing good balance, remaining on the bit without leaning on the hand and going forward with light-cadenced steps and good hock action. A canter to the right, for instance, will have the footfalls follow one another in the following sequence: left hind, left diagonal (simultaneously left fore and right hind), right fore, followed by a moment of suspension with all four feet off the ground before the next stride begins. The quality of the canter is judged by the general impression, the regularity and lightness of the three-time pace. The horse must be on the bit and well-engaged in the hindquarters with good hock action, and must have the ability to maintain his rhythm and natural balance throughout the movement and the transitions. The horse must remain straight on the straight lines.

#### **ARTICLE C506 REINBACK**

The reinback is a backward movement in which the feet are raised and set down simultaneously by diagonal pairs. The feet should be well raised and the hind feet remain well in line.

At the preceding halt as well as during the reinback, the horse, although standing motionless and moving back respectively, should remain on the bit, maintaining his desire to move forward.

Anticipation or precipitation of the movement, resistance to or evasion of the hand, deviation of the quarters from the straight line, spreading or inactive hind legs and dragging fore feet are serious faults.

If, in a dressage test, a trot is required after a reinback, the horse should move off immediately into his pace, without a halt or intermediate step.

#### **ARTICLE C507 SHOULDER-IN**

Shoulder-in for the driven horse is performed in Collected Trot. The leaders are positioned so that the outside leader's tail is in front of the head of the pole. The leaders' shoulders are taken to the inside with a constant angle of approximately 30 degrees and a slight but consistent bend in the neck. The inside hind leg steps forward into the line of the outside front leg so that the horses are working on three tracks. Impulsion, rhythm and engagement

must be maintained throughout. Too much bend in the neck results in loss of rhythm and suppleness. The wheelers must remain straight with no counterbend.

#### **ARTICLE C508 DIAGONAL YIELD**

Horse nearly parallel to Center line, crossing legs diagonally, hind direction diagonal front together, with slight flexion to the inside.

#### **ARTICLE C509 STRETCHING THE FRAME**

Athletes lengthen the reins gradually to the Horse(s) using a guided hand, to encourage and enable the Horse's neck to stretch forwards and downwards. As the neck stretches forwards and downwards, the Horse's mouth should reach the horizontal line corresponding with, but not lower than, the top point of the shoulder. An elastic and consistent contact with the Athlete's hands must be maintained and at no point should slack or loose rein be visible during the exercise. The same rhythm and impulsion will be maintained, and the Horse should remain light in the shoulders with the hind legs well-engaged. As soon as stretching of the frame has been demonstrated, the Athlete will bring the Horse(s) back to the preceding head carriage by retaking the reins during which the Horse must accept the contact without resistance in the mouth or poll.

#### **ARTICLE C510 TRANSITIONS**

The changes of pace should be clearly shown when the horse's nose arrives at the prescribed marker; they should be quickly made, yet must be smooth and not abrupt. The rhythm of a pace should be maintained up to the moment the pace is changed or the horse halts. The horse should remain light in hand, calm and maintain a correct position.

In the lower divisions, transitions from trot to halt and from halt to trot may be executed progressively through the walk by making two or three well-defined walk steps.

#### **ARTICLE C511 HALF-HALT**

The half-halt is a hardly visible, almost simultaneous, coordinated action of the aids, (voice, whip, and hands of the driver), with the object of increasing the attention and balance of the horse before the execution of several movements or transitions to lesser and higher paces. In shifting slightly more weight onto the horse's quarters the engagement of the hind legs and the balance on the haunches are facilitated for the benefit of the lightness of the forehand and the horse's balance as a whole.

#### **ARTICLE C512 CHANGES OF DIRECTION**

At the changes of direction, the horse should adjust the bend of his body to the curvature of the line he follows, remaining supple and following the indications of the driver without resistance or change of pace, rhythm or speed.

#### **ARTICLE C513 FIGURES**

1. SERPENTINE: This is a series of half circles from one side of the arena to the other, connected by straight lines. Starting and finishing by driving into the corners is incorrect. The number of loops are prescribed in the tests.
2. FIGURE OF EIGHT: This figure consists of two exact circles of equal size as prescribed in the test, joined at the center of the eight. The horse should straighten an instant before changing direction at the center of the figure.
3. HALF-CIRCLE: This movement consists of a half-circle of stated diameter followed by a return to the original track on a straight line. In a pair or four-in-hand, the pole



should touch the center line briefly at the end of the half circle before returning to the track on a straight line.

4. THE DEVIATION: A gradual movement away from the long side of the arena to reach a maximum value prescribed with a gradual movement back to the track.

#### **ARTICLE C514                      COLLECTION**

1. The aim of the collection of the horse is:
  - a) To further develop and improve the balance and equilibrium of the horse, which has more or less been displaced by the additional weight of the vehicle.
  - b) To develop and increase the horse's ability to lower and engage his quarters for the benefit of the lightness and mobility of his forehand.
  - c) To add to the "ease and carriage" of the horse.
2. Collection is, in other words, improved and effected by engaging the hind legs, with the joints bent and supple, forward under the horse's body.
3. The position of the head and neck of a horse at the collected pace is naturally dependent on the stage of training and in some degree, on its conformation. It should, however, be distinguished by the neck being raised and unrestrained, forming a harmonious curve from the withers to the poll the poll being the highest point, with the head slightly in front of the vertical.

#### **ARTICLE C515                      SUBMISSION**

Submission does not mean a truckling subservience, but an obedience revealing its presence by a constant attention, willingness and confidence in the whole behavior of the horse, as well as by the harmony, lightness and ease he is displaying in the execution of the different movements. The degree of submission is also manifested by the way the horse accepts the bridle with a light contact and a supple poll or with resistance to or evasion of the driver's hand, being either "above the bit" or "behind the bit" respectively.

Putting out the tongue, keeping it above the bit or drawing it up altogether, as well as grinding the teeth and swishing the tail, are mostly signs of nervousness, tenseness or resistance on the part of the horse and must be taken into account by the judges in their marks for the movement concerned as well as in the collective mark for "submission". .

### **CHAPTER 3 – SPECIFICATIONS**

#### **ARTICLE C516      POSITION AND AIDS OF THE DRIVER**

1. The driver should be seated comfortably on the box so as to be relaxed and effective. Either the one- or two-handed method of driving is acceptable. Common to both methods, the elbows and arms should be close to the body with an allowing but steady hand enabling a consistent "feel" with the horse's mouth. Drivers should not be penalized or rewarded for using one style over another.
2. The use of the whip and the voice are important aids in driving. They should be used as effectively and unobtrusively as is reasonably possible.

#### **ARTICLE C517 DRESS**

Competitors are reminded that neatness should be the first requisite. The dress of the competitor and grooms must conform to the style of vehicle and harness used. Period costumes, however, are not desirable.

Driving aprons, hats, gloves and whip in hand are required for competitors. The whip must be of suitable style and adequate length.

#### **ARTICLE C518 ARENA AND EXERCISE AREAS**

1. The arena should be on as level ground as possible. The large arena is 100 meters long and 40 meters wide. The small arena is 80 meters long and 40 meters wide (see Section H, Appendix F for arena size options for VSEs). The following tests must be held in the large arena: Intermediate, Advanced, and FEI division tests. Arena measurements are for the interior of the arena enclosure. Arenas should be separated from the public by a distance of at least 5 meters, 10 if possible. The enclosure itself should consist of a low fence (boards, breakable chain, etc.) Letter A should be easy to remove, to let competitors in and out of the arena in a suitable way, and must be replaced at least 5 meters away from the arena.
2. The letters outside the enclosure should be placed about 0.5 meters from the fence and clearly marked. It is permissible to decorate the letters with flowers or greenery to enhance the appearance of the arena.
3. The marking of the center line, throughout its length, and the three points D, X, and G is required; they must be as clearly marked as possible without being of a nature to frighten the horses. On that account is recommendable: on a grass arena, to mow the grass on the center line shorter than the other parts of the arena, and on a sand arena to roll or rake the center line in a suitable way. In such cases the three points D, X, and G should be suitably mowed, raked or rolled about two meters straight across the center line.
4. In the case of inclement weather or during winter, the use of an indoor arena may be desirable with the necessary modifications to meet local conditions. The requirements for the outdoor arena, however, apply as far as is possible.
5. An exercise area must be provided far enough away from the arena so as not to disturb the competitors during their tests. It should be of sufficient size for several competitors to prepare their horses at the same time. If possible a practice arena with perimeters and letters should be provided.

### **CHAPTER 4 – DRIVEN DRESSAGE TESTS**

#### **ARTICLE C519 DRIVEN DRESSAGE TESTS**

The American Driving Society approves and issues dressage tests for use in EQUESTRIAN CANADA sanctioned driving competitions (including pleasure shows and combined driving events). The FEI is responsible for issuing tests for international competitions and may be used in Advanced Division competitions. Tests cannot be modified or simplified without the approval of the ADS Dressage Committee or the FEI Driving Committee.

1. For use in national competitions:
  - a) ADS Training Division Tests: The purpose of these tests is to establish that the correct foundation is being laid for the training of the driving horse requiring the green horse to move freely forward in a free walk on long rein and the working

trot, in rhythm while accepting the bit with relaxation, through transitions and 40 m. circles. This division is also intended to encourage the inexperienced driver.

- b) ADS Preliminary Division Tests: The purpose of these tests is to establish that the horse has acquired a degree of balance and suppleness in addition to the rhythmical, free forward motion expected at the Training Division. While consistently accepting the bit the horse exhibits more activity of the haunches in the working trot and lengthened walk. To be demonstrated in: 30 m. circles, 20 m. half circles, 3 loop serpentine, and lengthened trot.
  - c) ADS Intermediate Division Tests: The purpose of these tests is to establish that the horse has become more freely forward with greater use of the haunches than at the Preliminary division, while remaining light in hand without resistance. To be demonstrated in the working walk and trot, the lengthened trot, the 5 second halt, the reinback, and the five loop serpentine.
  - d) ADS Advanced Division Tests: The purpose of these tests is to establish that the horse has acquired a greater degree of suppleness, balance and lightness in hand than at the Intermediate division while remaining reliably on the bit, producing more impulsion through further strength in the haunches and relaxation of the back and poll enabling the driver to collect and extend the trot. To be demonstrated in the collected and extended trot, the reinback, and the 10-second halt on the bit.
2. **National Championships** (Advanced classes) and Advanced Division competitions shall use the current prevailing FEI tests as stipulated for the turnout.
  3. **Freestyle Tests.** Provided it is not part of a Combined Driving Event, Organizing Committees may arrange a Freestyle dressage competition with or without music. The method of scoring must be clearly explained in the Prize List. In principle, the Judges should give one set of marks for content and another for general impression. The program selected by the Competitor may not exceed six minutes. The President of the Ground Jury must ring the bell for the first time after five minutes. The bell will be rung again after six minutes to indicate that the Competitor must bring the performance to an end immediately. Criteria for judging are set out in Appendix 5E – *Freestyle Dressage Score Form*

## **ARTICLE C520 EXECUTION OF THE TESTS**

1. The dressage test must be driven from memory except for the Training Division tests where the test may be called. If the test is called, it is the responsibility of the competitor to arrange for a person to call the test. Lateness and errors in announcing the test will not relieve the driver from “error penalties”. Announcing the test is limited to reading the movement as it is written, once only. Additional repeating of movements by the caller may be penalized at the discretion of the judge. A competition cannot require competitors to use callers employed by the show management. Any outside assistance (other than ‘calling’ at the Training Division) is forbidden and will result in elimination.
2. No passengers are permitted and grooms must sit in their correct places. One groom is optional for singles; one groom is mandatory for pairs and tandems and VSE unicorn and four-in-hands; and two grooms are mandatory for horse and pony unicorns and four-in-hands. A knowledgeable adult horseman must accompany a Junior driver in accordance with Article C102.6. No additional grooms or passengers are permitted. Failure to comply incurs elimination.

3. At the salute, drivers must take the reins in one hand. A lady shall raise the whip vertically in front of her face; a gentleman shall remove his hat (except when wearing approved protective headgear) and let his arm drop loosely along his body or may render the salute as does the lady. The whip salute is used to acknowledge the judge at the start and finish of an individual test or at the beginning and end of a dressage test. The whip salute is also performed in the following ways.
  - a) By moving the whip, held in the right hand, to a vertical position, the butt end even with the face.
  - b) By moving the whip, held in the right hand, to a position parallel with the ground, the handle before the face.
  - c) A gentleman may place the whip in his left hand and remove his hat.
4. Error of Test: If a competitor attempts to perform a movement, or attempts to maintain the pace required and fails to do so, but does not deviate from the track, the President of the Ground Jury may either treat it as an "Error of Course" (see (5) below), or he may decide to leave the judges to give the movement an appropriate mark.
5. Error of Course: It is an "Error of Course" when a competitor deviates from the required track or when a movement is performed at the wrong pace or omitted altogether.
  - a) In the event of a competitor making an Error of Course, the President of the Ground Jury will ring the bell and stop the competitor. The competitor must then resume the test from the beginning of the movement where the error was made. If the competitor is in any doubt, he may approach the President of the Ground Jury for instructions.
6. For "*an error of course*" or if a groom dismounts, penalty marks will be levied as follows:
  - a) First incident: ..... 5 penalty marks
  - b) Second incident: ..... 10 penalty marks
  - c) Third incident: ..... Elimination
7. If the Jury has not noted an error, the competitor has the benefit of the doubt.
8. Disobedience – any resistance in the forward movement, kicking or rearing is considered to be disobedience and will be penalized as:
  - a) First incident: ..... 5 penalty marks
  - b) Second incident ..... 10 penalty marks
  - c) Third incident ..... Elimination
9. Penalty points are noted only on the judge's sheet held by the President of the Jury.
10. Disconnected or broken harness: Should the rein, pole strap, chains or trace become disconnected or broken, or should the horse get a leg over the pole, trace or shaft, the President of the Ground Jury will ring the bell and a groom must dismount and reconnect or repair the broken part. The competitor will be penalized for a groom(s) dismounting.
11. In a case of marked lameness, the Judge or President of the Jury informs the competitor that he/she is eliminated. There is no appeal against this decision.
12. A competitor who does not enter the arena within 90 seconds after the entry bell is rung for his/her test shall be eliminated. No competitor can be required to drive prior to his/her scheduled time.

13. If, during the test, the entire turnout leaves the arena, the competitor is eliminated at the discretion of the Jury. If part of a turnout leaves the arena, it shall be scored as a poor movement and appropriate marks awarded.
14. A competitor leaving the arena at the end of a test in any way other than prescribed in the test will be penalized by an error. A competitor leaving the arena at the end of his/her test at any point other than "A" shall be eliminated.
15. Competitors shall be allowed to drive the outer perimeter of the arena before entering whenever deemed possible by the TD and approved by the President of the Jury.
16. Competitors will not be allowed to school in or around the arena while a class is in progress.
17. The judge may allow a competitor to restart a test, if in his/her discretion some unusual circumstance has occurred to interrupt a test.
18. Any intervention by a third party not riding on the vehicle, whether solicited or not, with the object of facilitating the task of the Competitor or his horses, is forbidden as Outside Assistance. Grooms must remain seated in their proper places between entering and leaving the arena. They are not permitted to handle the reins, the whip or speak unless they are dismounted and the vehicle is stationary.

#### **ARTICLE C521 TIME**

The execution of the tests is not timed. The times shown on the test sheets are for scheduling information only.

### **CHAPTER 5 – SCORING**

#### **ARTICLE C522 MARKING**

1. All movements, and certain transitions from one to another which have to be marked by the judge(s), are numbered on the judge's sheets.
2. They are marked from 0 -10, with 0 being the lowest mark and 10 the highest mark, half marks acceptable.
3. The scale of marks is as follows:
 

10 Excellent	4 Insufficient
9 Very Good	3 Fairly Bad
8 Good	2 Bad
7 Fairly Good	1 Very Bad
6 Satisfactory	0 Not Executed
5 Marginal	Half-marks are allowed.

"Not executed" means that practically nothing of the required movement has been performed.

4. Collective marks are marked after the competitor has finished his/her performance for:
  1. Gaits
  2. Impulsion
  3. Submission
  4. The driver's handling of the reins and whip; correctness and effect of the aids.
 Each collective mark is awarded from 0 to 10, half marks acceptable.

5. The collective marks, as well as certain difficult and/or infrequently repeated movements, can be given a co-efficient of more than 1, which is fixed by EQUESTRIAN CANADA and appears on the test.
6. The mark for each movement should first establish the fact of whether the movement is performed insufficiently (four or below) or (marginal or better, five or above). The judge should state the reason for each mark, as far as possible, but particularly for marks 5 downward.
7. Accuracy (moderate) should be a factor only if the inaccuracy avoids the difficulty of the movement, i.e., a larger circle avoids the difficulty of a 20 m circle. A movement which must be carried out at a certain point of the arena should be done at the moment when the horse's nose is above this point.
8. If a problem appears once, it may be treated lightly by the judge. If it appears successively, he/she will score it more harshly each time, i.e., nodding, stumbling, shying, etc.
9. Signs of tenseness or resistance on the part of the horse should be considered in the marks for each movement where they appear, as well as in the collective marks. Horses which get their tongues over the bit or perform with an open mouth shall be marked down.
10. The levels of dressage are offered as a means of evaluating a horse that is changing. The purpose of each test is printed thereon. The horse shall be considered in the light of the degree of training it should have achieved to be shown at that division.
11. Allocation of marks: The judges will allocate their marks individually, and there will be no consultation among judges once the competitor has commenced the test.
12. Multiple Turnouts: Pairs, Tandems, and Four-in-Hands will be judged as a whole and not as individual horses.
13. Pace: The definition of paces - movements will apply to all types and breeds of horses.
14. Terminology: The following must be considered when judging Driven Dressage movements:
  - a) Obedience and Lightness - willing response to aids without resistance; correctness of bend.
  - b) Regularity - the regularity, evenness and rhythm with which the horse puts his feet to the ground.
  - c) Contact - the tension in the reins between the driver's hands and the horse. It should be light and flexible and maintained at all times.
  - d) Impulsion - the willingness of the horse to go forward energetically at all times and to respond quickly and evenly to changes of pace. The horse must remain in balance while maintaining the same tempo with steps of equal size.
  - e) Straightness - carrying the head, neck and body in a straight line with the weight evenly divided among the legs.
  - f) Collection - roundness and engagement with good hock action, elevated poll allowing the shoulders to move with ease. The horse's energy is contained in a more deliberate pace than in the Working Trot. The haunches are more compressed, the croup is lowered, and the forehead is elevated to the same degree. The stride is shorter but more powerful than the working trot and the front legs will move from the shoulder with greater agility resulting in lightness and greater mobility throughout. The neck should be more arched. The shortening of the frame is not and never should be a result of pulling back but rather of asking and allowing the horse to move forward into the driver's hand.
  - g) Accuracy - Accuracy of turns, circles, serpentines, alongside rails, deviations.

## **ARTICLE C523            GENERAL IMPRESSION**

1. Principle: There are five boxes at the end of the Judges' Score Sheets for marks on General Impression.
2. Paces/Gaits: Regularity and freedom (if Four-in-Hand, Pair or Tandem, maintenance of pace/gait by all horses). The quality of paces/gaits in each movement is marked under the appropriate movement. The mark for the general impression must reflect paces/gaits and transitions during the whole test.
3. Impulsion: Moving forward, engagement of the hindquarters (if Four-in-Hand, Pair, or Tandem, all horses working). The level of impulsion may vary between movements and pace, but the mark for impulsion must reflect the performance of the horses through the test.
4. Obedience and Lightness/Submission: Response to aids, willing and without resistance. Correctness of bend. Suppleness.
5. Competitor: Use of aids, handling of reins and whip, position on the box, accuracy of the figures. The mark must reflect the consistent level of accuracy and quality of transitions.
6. Presentation
  - a) Appearance of competitor and grooms, cleanliness, fitness, matching and condition of horses, vehicle and harness.
  - b) Bandages and brushing boots are not permitted under any circumstances. Failure to comply entails 10 penalty points.

## **ARTICLE C524            CLASSIFICATION AND SCORING**

1. After each performance and after each Judge has given his/her collective marks, which must be done with due consideration, the judges' sheets pass into the hands of the scorers.
2. In Driven Dressage competitions, scores may be shown as the average score of all judges minus the penalty points from the Head Judge. At the discretion of the organizer, scores may be calculated as in combined driving or shown in percentages as in ridden dressage. See Appendix 5-D. For Combined Driving Events, scoring shall be according to Article C958.
3. In driven dressage competitions, the winner is the competitor having the highest total points or percentage, the second, the one with the next highest and so on. In the case of equality, the competitor with the highest marks received under General Impressions shall be declared the winner. When the scores for General Impressions tie, the judge may be required to decide on a winner after review of either score sheets or the Entries may remain tied at the Judge's discretion.

## **CHAPTER 6 – DRESSAGE OFFICIALS AND MANAGEMENT**

### **ARTICLE C525    GROUND JURY**

1. The invited judges compose the Ground Jury and must be selected from the current list of EC and/or PTSO Officials for Combined Driving or Driven Dressage Judges, or a qualified foreign judge with a Guest Card approved by EC. Article C610 - *Guest Cards*.
2. If there is only one judge, he/she is placed 5 meters from the end of the arena opposite the letter C. When two or three judges are used, one is placed at C, the second at B or E and the third should be placed 2.5 meters from the long side of the arena at H or M (if the second judge is at B, the third should be at H and vice versa). If this is not

possible, all three judges should be placed at the end of the arena, one at C, one 3 meters from the long side of the arena at M and the other 3 meters from the long side of the arena at H.

3. A separate enclosure (tent, trailer, etc.) should be provided for each judge. It should be raised at least 0.5 meters (20 inches) above the ground to give the judge a good view of the arena.

#### **ARTICLE C526 TECHNICAL DELEGATE**

1. There must be a Technical Delegate selected from the current list of EC and/or PTSO Officials of Pleasure Driving TDs or Combined Driving TDs or a qualified foreign Technical Delegate with a Guest Card approved by EC, under Article C610 - *Guest Cards*.

#### **ARTICLE C527 RESPONSIBILITIES OF MANAGEMENT**

1. Classes should be divided by similar turnouts (singles, pairs, fours, etc.). Horses may not be entered more than once in any dressage class. At Pleasure Driving Competitions or Driven Dressage Competitions, competitors may enter two consecutive divisions with the same horse and driver combination, e.g., Training and Preliminary or Preliminary and Intermediate.
2. No judge shall be required to officiate longer than eight hours in one day. A scheduled 10 minute break must be provided for every two hours of judging.
3. A tentative class schedule must be included in the Prize List. If the day of competition is changed, forcing a competitor to withdraw, his/her entry fees must be refunded.
4. Organizers should prepare a time schedule including all driving times. If possible, competitors should be notified of their driving time in advance. In preparing the schedule consideration should be given to drivers entered in more than one class.
5. Time intervals should be scheduled between classes to allow for judges' breaks and award presentations. The time schedule should be posted in a conspicuous place by noon the day before the competition.
6. Following the presentation of awards for each class, the judge's score sheet should be given to the competitor.

### **CHAPTER 7 – WELFARE OF THE HORSE**

#### **ARTICLE C528 CRUELTY**

The General Regulations refer to cruelty (see Article [C104](#)).

#### **ARTICLE C529 EQUIPMENT**

1. Any kind and type of riding snaffle or driving bit (similar but not limited to those pictured below) is permissible, so long as it conforms to Article C121. Style of harness or vehicle should not influence the type of bit being used. Bits cannot be connected to reins by clips or snaps. Bitless bridles and chain bits are prohibited.
2. Bandages and brushing boots are not permitted. Failure to comply entails 10 penalty points.
3. Auxiliary reins, including any type of check reins or martingales are not permitted. Side checks may be used in Training division only.



**EXCEPTION:** Martingales are appropriate to Park Gate and Stanhope Gigs and George IV Phaetons.

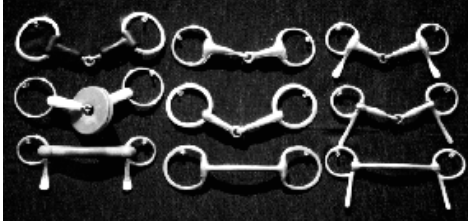

Examples of Snaffle bits: Egg butt (rubber) jointed mouthpiece; Egg butt-thick; Half cheek egg butt - thick; Happy mouth ring snaffle with discs; Ring snaffle-thin; Half cheek-loose cheek; Vulcanite half cheek-straight bar Mullen; Egg butt - Mullen straight; Half-cheek mulling – thin.

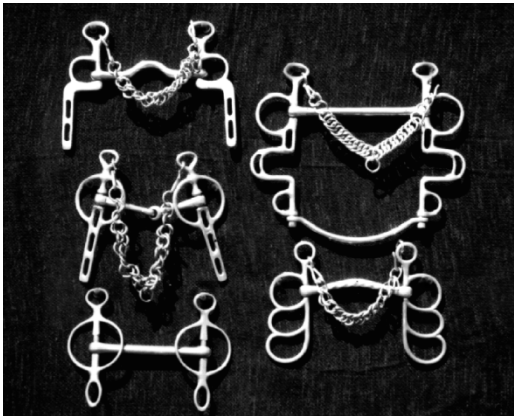

Examples of Liverpool (clockwise from top left): Liverpool "Military" elbow curb mouth; Buxton (with pair bar); Butterfly Mullen mouth; Liverpool straight bar; Liverpool loose-cheek snaffle.



Examples of French Link (top to bottom): Egg butt French link, Ring snaffle French link, Egg butt French link with copper roller, Dee Ring Egg butt French Link Snaffle (top), Buxton (bottom)

## APPENDICES

### APPENDIX 5-A – ABBREVIATIONS

@.....	at	L. ....	left
abr. ....	abrupt	lat. ....	lateral(ly)
attn. ....	attentive	ld. ....	lead
bal. ....	balance	let. ....	letter
bd. bdg. ....	bend, bending	lngth. ....	lengthening
bef. ....	before	long. ....	longitudinal
beh. ....	behind	o. ....	circle
bet. ....	better	ob. ....	obedient
bk. ....	back	obv. ....	obvious
b. ....	bent	outw. ....	outward
btwn. ....	between	pos. ....	position
c-ln. ....	centerline	prec. ....	precise, precision
cfl. ....	counter flexed	r.bk. ....	rein-back
col. ....	collected, collection	reg. ....	regular, regularity
cor. ....	corner	res. ....	resistant, resistance,
corr. ....	correct	rhy. ....	rhythm
cant. ....	canter	rt. ....	right
d. ....	driver	sal. ....	salute
dep. ....	depart	sat. ....	satisfactory
diag. ....	diagonal	serp. ....	serpentine
dir. ....	direction, direct(ly)	slt. ....	slight(ly)
disob. ....	disobedient	sm. ....	small
eng. ....	engaged, engagement	Y.....	square
ext. ....	extended, extension	Y fr. o. ....	square front only
flex. ....	flexed, flection	st.b.....	stepped back
fwd. ....	forward	str.....	straight
gd. ....	good	strg.o. ....	strungout
h. ....	horse	thru.....	through
ha. ....	haunches	tr. ....	trot
ht. ....	halt	trans.....	transition
hur. ....	hurried	↑ trans.....	up transition
imp. ....	impulsion	↓ trans.....	down transition
inattn. ....	inattentive	unus.....	unusual
incomp. ....	incomplete	us. ....	usual(ly)
incor. ....	incorrect	v. ....	very
inw. ....	inward	vert. ....	vertical
irreg. ....	irregular	wr. ....	Wrong

## APPENDIX 5-B – LARGE AND SMALL ARENAS

Diagram of Large (100m) Arena

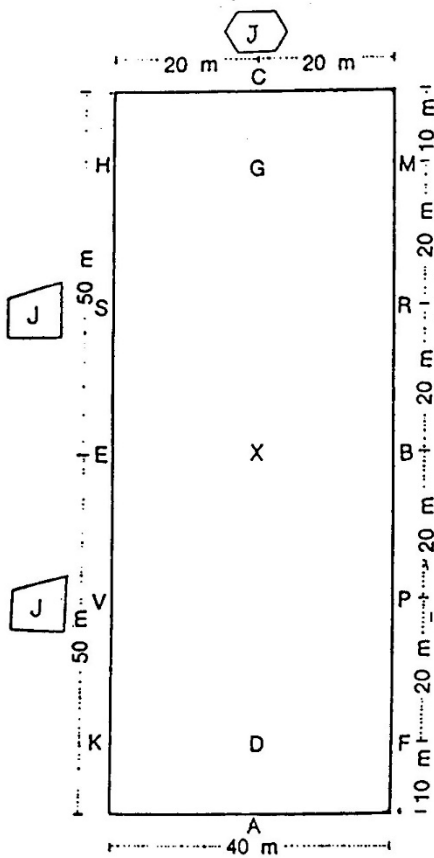
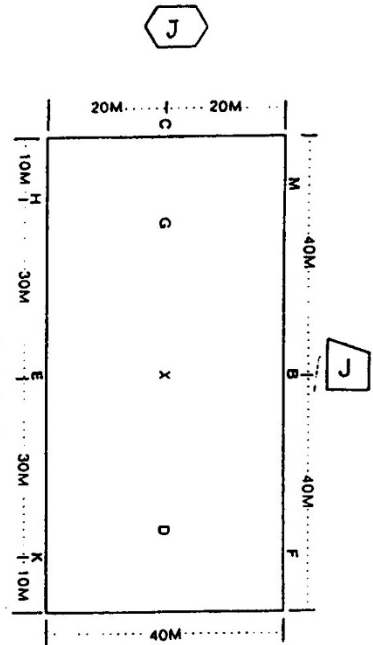

Diagram of small (80m) arena



For size-adjusted arenas suitable for VSEs, see Appendix 9-F.

## APPENDIX 5-C – LIST OF DRESSAGE TESTS

ADS Dressage Tests are authorized for use at EC-sanctioned competitions and are available from the event Organizer or can be downloaded from the ADS Website: [www.americandrivingsociety.org](http://www.americandrivingsociety.org). FEI tests: [www.fei.org/](http://www.fei.org/)

### DRIVEN DRESSAGE TESTS

TEST	AVERAGE DRIVING TIME 40mx80m Ring*	SCHEDULE TIME MIN. TIME BETWEEN TESTS **
Training A	6 min	8 min
Training B	6½ min	8 min
Training C	5½ min	7 min
Preliminary A	7½ min	9 min
Preliminary B	7 min	9 min
Preliminary C	8 min	10 min
Intermediate A	8½ min	10 min
Intermediate B	8½ min	10 min
Intermediate C	8 min	10 min

Tests driven by tandems and four-in-hands should be driven in a 40 x 100 meter arena, but are allowed in 40 x 80 meter.

\* Add 1 minute to Schedule/minimum time between drivers for any class driving in 40m x 100m ring.

\*\* Schedule extra time for VSE Classes held in 40m x 80m ring. Do not add time for VSE classes held in size adjusted rings, refer to Appendix 9-F for size-adjusted arena options.

### ARENA TRIAL DRESSAGE TESTS

TEST	AVERAGE DRIVING TIME*	SCHEDULE TIME MIN. TIME BETWEEN TESTS
AT Training A	5½ min	7 min
AT Training B	5½ min	7 min
AT Preliminary A	6 min	8 min
AT Preliminary B	6 min	8 min
AT Intermediate A	6 min	8 min
AT Intermediate B	6 min	8 min
AT Advanced	7 min	9 min

\* Time dependent on ring size and access.

## APPENDIX 5-D – DRESSAGE TEST SCORING

### Combined Driving Competitions (See Article C956)

1. Points awarded by all Judges are averaged (Average Total Points)
2. Average Total Points x factor = Adjusted score
3. Maximum possible (160) – Adjusted score + additional penalties = penalties.

### Driven Dressage Competitions only (alternative method – Article C523)

1. Points awarded by all Judges are averaged (Average Total Points)
2. Average Total Points – additional penalties = Total score
3. Total Score ÷ Total Points x 100 = Test %

<b>TEST Includes Presentation Score</b>	<b>TOTAL POINTS</b>	<b>FACTOR (MAX. 160)</b>
Training A	160	1.000
Training B	180	0.889
Training C	170	0.941
Preliminary A	190	0.842
Preliminary B	190	0.842
Preliminary C	200	0.800
Intermediate A	200	0.800
Intermediate B	210	0.762
Intermediate C	210	0.762
<b>ARENA TRIALS</b>		
<b>2020 AT Tests (Include Turnout Scores)</b>	<b>Total Points</b>	<b>Factor (Max 160)</b>
AT Training A	180	.889
AT Training B	180	.889
AT Preliminary A	190	.842
AT Preliminary B	200	.800
AT Intermediate A	190	.842
AT Intermediate B	190	.842
AT Advanced	190	.842

## APPENDIX 5-E - FREESTYLE DRESSAGE SCORE FORM

Time allowed 4-6 minutes                      Entry # \_\_\_\_\_  
 (40m x 80m Arena) Description: \_\_\_\_\_

**Requirements:**

- Three distinct gates, minimum 20m each. No cantering
- Circle or half circle both ways (No dimension specified)
- Serpentine of 3 loops
- Halt and Salute at end of test (optional at start of test)
- Costumes allowed
- Provide a written list of movements for the judge

**Technical Scores**

Gaits		mark	Score
1		10x2	
2		10x2	
3		10x2	

**Movements**

Gaits		Mark	Score
1	Left Circle or half Circle	10	
2	Right Circle or half Circle	10	
3	Serpentine	10	
4	Halt and Salute (end of test)	10	
TOTAL		100	
Factor		X .4	
TOTAL TECHNICAL			

**Artistic Scores**

Description	Mark	Score
Rhythm, energy, elasticity (impulse, relaxation)	10	
Harmony between Horse and Driver (submission)	10	
Choreography, use of arena, inventiveness (phrasing of music / movements, cohesive pattern)	10x4	
Degree of Difficulty (suitability to horse's ability)	10	
Choice of music and its interpretation	10x3	
TOTAL		100
Factor		X .6
TOTAL ARTISTIC		

<b>TOTAL TECHNICAL &amp; ARTISTIC</b>	
---------------------------------------	--

## PART SIX – LICENSED OFFICIALS

### CHAPTER 1 – COMPETITION OFFICIALS

#### ARTICLE C601 COMPETITION OFFICIALS

##### 1. GENERAL REQUIREMENTS:

- a) Judges, Technical Delegates Course Designers and Driving Stewards must hold a Gold Sport Licence and pay their respective Officials fees.
- b) Only Equestrian Canada licensed Driving Officials in good standing or officials in possession of a valid Guest Card may officiate at EC-sanctioned driving competitions.
  - i. PTSO licensed Driving Officials may officiate at select EC sanctioned driving competitions per Appendix 1A, Event Summary Table.
  - ii. All EC Driving Officials are allowed to officiate additionally at PTSO-sanctioned events, in accordance with Section A, Article A1301.8
- c) Persons who wish to gain experience to become a Judge, Technical Delegate, Course Designer or Driving Steward must register in the EC Driving Officials Learner Program before receiving credit for any competition experience.
- d) Individuals must have separate qualifications for each division in order to be qualified to officiate.
- e) Guest Cards Guest cards may be issued in special situations as specified under Article C610 - *Guest Cards* with the approval of Equestrian Canada office.
- f) Equestrian Canada Driving Learner Experience and Evaluation forms are only completed and retained for individuals who are registered in the Learner program or are current Recorded officials.

##### 2. JUDGES

Judges shall be classified as Pleasure Driving, Combined Driving and Driven Dressage and Draft Horse Driving. The three levels of judges are Learner, Recorded and Senior. See the following articles:

- a) Classification and Description
  - i) Pleasure Driving – Article C602
  - ii) Combined Driving – Article C605
  - iii) Driven Dressage – Article C606

##### 3. TECHNICAL DELEGATES

Technical Delegates shall be classified as to Pleasure Driving or Combined Driving. The three levels are Learner, Recorded and Senior. See the following articles:

- a) Classification and Description
  - i) Pleasure Driving – Article C603
  - ii) Combined Driving – Article C607

##### 4. COURSE DESIGNERS

Course designers shall be classified as to Pleasure Driving or Combined Driving. The three levels of Course Designers are Learner, Recorded and Senior. See the following articles:

- a) Classification and Description
  - i) Pleasure Driving – Article C604
  - ii) Combined Driving – Article C608

##### 5. DRIVING STEWARDS

There are two levels for Driving Steward – Learner, Licensed.



## 6. LEARNERS

- a) Individuals interested in becoming EC Driving Officials must enroll in the EC Driving Officials Learner program. Learner Officials must provide two letters of recommendation, one of which must be from a current Senior Driving Official, the second from either a Driving Official or an experienced competitor, both of whom are senior Equestrian Canada Sport Licence holders in good standing. Those persons giving such recommendations must have reasonable knowledge of the applicant. The foregoing conditions must be completed prior to commencing their practical experience or monitoring requirements as set out in these rules. In order to apply as a Learner, the applicant must be at least 18 years old and have had experience in driving as competitor, trainer, driver or competition official. A non-refundable fee is required for the initial application in each category. Note: Learner Officials are not covered by Equestrian Canada officials' insurance.

**Note:** Learner Officials are not covered by Equestrian Canada officials' insurance.

- b) Responsibilities and Restrictions of a Learner:
- i) Permission for an approved Learner to participate at a sanctioned Competition must be first obtained from the Organizing Committee for a specific competition, and then from the Senior Licensed Official with whom the Learner will work.
  - ii) A Learner shall be provided with an appropriate technical package and a Judge's Card to evaluate the various entries but must not consult with the Judge until a class is completed, unless given specific permission to do otherwise by the Head Judge or the President of the Jury.
  - iii) A Learner has no authority as to the merits of a competitor and must not attempt to influence a Judge's decision.
  - iv) There shall be no limit to the number of times a person may participate as a Learner.
  - v) There shall be no more than one Learner per Senior Official working at an Event, unless approved in writing by EC prior to the Event.

## ARTICLE C602 JUDGES - PLEASURE DRIVING

### 1. CLASSIFICATION AND DESCRIPTION

- a) **Senior Pleasure Driving Judge** – an individual who has been approved in this classification, and is listed in the Official's Directory as "S". A Senior Judge is entitled to officiate alone at any competition in the classification for which he is approved including Pleasure Driving Technical Delegate. A Senior Pleasure Driving Judge who is also licensed as a Senior Pleasure Driving Technical Delegate may serve in both capacities at the same show if that show offers no more than 15 classes with no more than 2 obstacle courses. A Senior Pleasure Driving Judge may officiate at all EC-sanctioned Pleasure Driving Competitions including Pleasure Drives and may act as a Pleasure Driving Technical Delegate. After one year on probation, a Senior Pleasure Driving Judge may officiate at National Championships.
- b) **Recorded Pleasure Driving Judge** – an individual who has been approved in this classification, and listed in the Officials Directory as "r". A Recorded Pleasure Driving Judge may officiate alone at any Pleasure Driving Competition that does not exceed one day or 15 classes spread over the duration of the show. They may also be a Judge, when accompanied by a Senior Pleasure Driving

Judge, at shows that are greater than 15 classes or one day in length. Applicants will be considered for promotion to Senior Judge after achieving ‘r’ status in the Pleasure Driving division, based on satisfactory evaluations from at least four Pleasure Driving shows from EC, USEF or ADS Recorded Judges.

- c) **Learner Pleasure Driving Judge** – an individual who has been accepted into the EC Driving Official learner program in this classification. A Learner Pleasure Driving Judge may not officiate. They may shadow judge and monitor only, under the supervision of an EC Senior Pleasure Driving; or a USEF or ADS Recorded Judge. The purpose of the Learner status is to gain experience, educate and familiarize the Learner with the duties, obligations and requirements of the Pleasure Driving Judge and to afford an avenue for advancement and be a prerequisite for advancement to the Recorded status.

## **ARTICLE C603 TECHNICAL DELEGATE – PLEASURE DRIVING**

### **1. CLASSIFICATION AND DESCRIPTION**

- a) **Senior Pleasure Driving Technical Delegate** – an individual who has been approved in this classification, and listed on the Officials Directory as “S”. A Senior Pleasure Driving Technical Delegate may officiate at in EC-sanctioned Pleasure Driving Competitions including Pleasure Driving Marathons and National Championships, subject to the provisions of Article C601.3 - *Classifications*. They may officiate as a Pleasure Driving Technical Delegate, subject to the restrictions imposed by the Officials licence status under this article. A Senior Pleasure Driving Technical Delegate who is also licensed as a Senior Pleasure Driving Judge may serve in both capacities at the same show if that show offers no more than 15 classes with no more than 2 obstacle courses. After one year on probation, a Senior Driving Technical Delegate may officiate at National Championships.
- b) **Recorded Pleasure Driving Technical Delegate** – an individual who has been approved in this classification, and listed on the Officials Directory as “r”. A Recorded Pleasure Driving Technical Delegate may officiate alone at any Pleasure Driving Competition that does not exceed one day or 15 classes. A Recorded Pleasure Driving Technical Delegate may judge obstacle classes at a Pleasure Driving Competition at which he is **NOT** the Technical Delegate. Applicants will be considered for promotion to Senior Technical Delegate after having achieved ‘r’ status, in the Pleasure Driving division based on satisfactory evaluations from at least four Pleasure Driving competitions from EC, USEF or ADS Officials. An applicant’s competitive experience may be considered during the promotion process.
- c) **Learner Pleasure Driving Technical Delegate** – an individual who has been accepted into EC Driving Official learner program in this classification. A Learner Pleasure Driving Technical Delegate may not officiate. They may accompany and monitor only, under the supervision of a Senior Pleasure Driving Technical Delegate or under the supervision of a Senior Pleasure Driving Judge who is acting in the capacity of the competition’s Technical Delegate. The purpose of the Learner status is to gain experience, educate and familiarize the Learner with the duties, obligations and requirements of the Pleasure Driving Technical Delegate and to afford an avenue for advancement and be a prerequisite for advancement to the Recorded status.

### **2. DUTIES**

- a) A Technical Delegate at a given event shall not be a competitor. If management elects to form a type of hearing committee, it is a natural progression to appoint the Technical Delegate to the committee. However, if the appeal is against the decision or action of the Technical Delegate, he must declare a conflict and remove himself from the appeal process for this specific appeal.
- b) A Technical Delegate shall not officiate at any competition in which a member of his family is competing.
- c) Prior to submitting the *Competition Application Form for Driving Events* to the EC Competitions department, the Technical Delegate is responsible for reviewing and signing the Prize List for conformation to these rules. For Events not requiring a Technical Delegate, the review and approval are the responsibility of the Head Judge or most senior EC official involved.
- d) If an emergency necessitates the replacement of a designated Technical Delegate, the above restrictions shall not apply.
- e) Although a Technical Delegate may design or construct a course, the Technical Delegate is not intended to be a Course Designer or a Course Builder. The Technical Delegates primary goal and duty is, and must remain, to assure that a course is constructed in a safe and appropriate fashion and within the framework of the Rules.
- f) A Technical Delegate should clearly understand that he has no authority in connection with the management and judging of any event. He is the representative of Equestrian Canada and should point out in a diplomatic manner any instance where the rules and directives are not enforced. He should not dictate to judges or management, but should immediately report to the appropriate officials any violations of the rules, which might invalidate a class or induce disciplinary action by Equestrian Canada. He should keep himself available to judges, competitors and management at all times to clarify the application of Equestrian Canada rules and investigate any situation in which the rules are not upheld. Additional duties include, but are not limited to, the following:
  - i) To protect the interests of the competitors, judges, and management.
  - ii) To report to the management any misrepresentation or substitution of entry without waiting for a protest.
  - iii) To ascertain that judges either are approved in divisions to which assigned or that the competition has a guest card for the divisions not covered.
  - iv) To measure all animals required to be measured according to the rules.
  - v) To inspect, prior to each class, each obstacle course to insure that the specifications are followed. **NOTE:** The technical delegate must bear in mind that he has no right to alter a course for aesthetic reasons. Alterations are in order only if the plan violates a specific rule or is clearly undrivable or unsafe.
  - vi) To inspect any marathon course or permanent cross country course at a time early enough to allow any changes or alterations to conform to the rules and directives for safety and drivability, to ascertain that any “allowed times” are reasonable considering terrain and weather and supervise the briefing of competitors by the course designer
  - vii) To satisfy himself that all accommodations for horses, if present on the competition site, are adequate and that schooling areas are suitable and safe.
  - viii) To report to the management any offense or violation of the rules and prefer charges against violators if not properly handled by management.

- ix) To furnish Equestrian Canada with a written report as to the conduct of the event, including any offense or violation of the rules, within 14 days of its completion, on the Equestrian Canada forms.
- x) To inspect all timing equipment assuring that it is in good working order and adequate for specific timing duties; to ascertain that adequate provision has been made for back-up timing during each applicable event and to instruct all timers how the equipment is to be used.
- xi) To complete evaluation forms for any Learner or Recorded Technical Delegate who is participating, at the competition and mail it to Equestrian Canada office.
- xii) To ascertain that scoring of all competitions is prompt, and that scoring procedures are correct; in particular, that the collection of data, posting of scores and ranking of competitors follows the procedures outlined in these rules.

## ARTICLE C604 COURSE DESIGNER – PLEASURE DRIVING

### 1. CLASSIFICATION AND DESCRIPTION

- a) **Senior Pleasure Driving Course Designer** - an individual who has been approved in this classification by the Licensed Officials Committee, is listed in the Official's Directory as "S", and entitled to design at all Pleasure Driving competitions.
- b) **Recorded Pleasure Driving Course Designer** - an individual who has been approved in this classification by the Licensed Officials Committee, is listed in the Official's Directory as an "r", and entitled to design at one or two day Pleasure Driving Competitions. Applicants will be considered for promotion to Senior Course Designer after achieving 'r' status in the Pleasure Driving division and serving as a Course Designer in at least three Pleasure Driving competitions based on satisfactory evaluations.
- c) **Learner Pleasure Driving Course Designer** – an individual who has enrolled in the EC Driving Official Learner Program and may not officiate. The purpose of the Learner status is to gain experience, educate and familiarize the Learner with the duties, obligations and requirements of the Course Designer and to afford an avenue for advancement and be a prerequisite for advancement to the Recorded status.

### 2. DUTIES

- a) Responsible for the design and supervision of construction of Obstacle Driving Courses and Pleasure Driving cross-country courses.
- b) To provide:
  - i) For Show management's approval: diagrams and material lists necessary for the construction of all obstacle and cross country- courses in sufficient time for their proper construction
  - ii) For the Technical Delegate: diagrams of all obstacle courses and marathon maps including their lengths and respective timing requirements, including any alternations planned should ties occur which necessitate a "drive-off"
  - iii) For the Show Secretary: maps and course designs for posting at proper times.

- c) To oversee the placement of temporary obstacles/road cone before each class and insure that each obstacle conforms to the course diagram before each individual round.
- d) To insure that each obstacle conforms to the dimensions specifications under these Rules.

## ARTICLE C605 JUDGE - COMBINED DRIVING

### 1. CLASSIFICATION AND DESCRIPTION

a) **Senior Combined Driving Judge** - is an individual who has been approved in this classification, and listed on the Officials Directory as “S”. A Senior Combined Driving Judge is entitled to officiate alone at any EC-sanctioned Combined Driving Competition in the classification for which he is approved. After one year on probation, a Senior Combined Driving Judge may officiate at National Championships. A senior Combined Driving Judge may be President of the Jury.

b) **Recorded Combined Driving Judge** - is an individual who has been approved in this classification, and listed on the Official’s Directory as “r”.

A Recorded Combined Driving Judge may officiate alone, or be President of the Jury at any Combined Driving Event for the Training and Preliminary divisions. A Recorded Combined Driving Judge may officiate at competitions offering the Intermediate and Advanced divisions but may not be President of the Jury. Applications will be considered for promotion to Senior Judge after achieving ‘r’ Judge status in the Combined Driving division based on satisfactory evaluations from at least four upper division Combined Driving Events from FEI; EC; USEF or ADS Recorded Judges.

c) **Learner Combined Driving Judge:**

A Learner is a person who has been accepted into the EC Driving Official Learner Program in one or more classifications. A Learner Combined Driving Judge may not officiate. They may shadow judge or monitor under the supervision of a Senior Combined Driving Judge. The purpose of the Learner status is to gain experience, educate and familiarize the Learner with the duties, obligations and requirements of the Combined Driving Judge and to afford an avenue for advancement and be a prerequisite for advancement to the Recorded status.

## ARTICLE C606 JUDGE – DRIVEN DRESSAGE

### 1. CLASSIFICATION AND DESCRIPTION

a) **Senior Driven Dressage Judge** – is an individual who has been approved in this classification, and listed on the *Officials Directory* as “S” and does not hold similar classification as a Combined Driving Judge. After one year on probation, a Senior Driven Dressage Judge may officiate at National Championships. A Senior Driven Dressage Judge may officiate at Driven Dressage Competitions, Dressage Classes offered as part of Pleasure Driving Competitions, or as a member of Jury at a Combined Driving Event with at least two other Combined Driving Judges (see Article C987.1.5). A Driven Dressage Judge may not act as President of the Jury at a Combined Driving Event.

b) **Recorded Driven Dressage Judge** – is an individual who has been approved in this classification, and listed on the *Officials Directory* as “r” and does not hold

similar classification as a Combined Driving Judge. They may officiate at any Combined Driving Event at the Training, Preliminary, Intermediate and Advanced divisions but may not be President of the Jury. A Recorded Driven Dressage Judge may officiate alone at Dressage Classes offered as part of Pleasure Driving Competitions, or as a member of Jury at a Combined Driving Event with at least two other Combined Driving Judges (see Article C987.1.5). Applications will be considered for promotion to Senior Driven Dressage Judge after having achieved 'r' status based on satisfactory evaluations from at least four Driven Dressage Competitions or Combined Driving Events from FEI; EC; USEF or ADS Recorded Judges.

- c) **Learner Driven Dressage Judge** – is an individual who has been accepted into the EC Driving Official Learner Program in one or more classifications. A Learner Driven Dressage Judge may not officiate. They may shadow judge or monitor under the supervision of a Senior Combined Driving Judge or a Senior Driven Dressage Judge. The purpose of the Learner status is to gain experience, educate and familiarize the Learner with the duties, obligations and requirements of the Driven Dressage Judge and to afford an avenue for advancement and be a prerequisite for advancement to the Recorded status.

## ARTICLE C607 TECHNICAL DELEGATE – COMBINED DRIVING

### 1. CLASSIFICATION AND DESCRIPTION

- a) **Senior Combined Driving Technical Delegate** – an individual who has been approved in this classifications, and listed on the *Official's Directory* as "S". A Senior Technical Delegate is entitled to officiate alone at any competition. They may officiate at all EC-sanctioned Combined Driving Competitions. A Senior Technical Delegate is a person who has been approved in this classification. They are entitled to officiate alone at any competition in the classification for which he is approved. After one year on probation, a Senior Combined Driving Technical Delegate may officiate at National Championships.
- b) **Recorded Combined Driving Technical Delegate** – is an individual who has been approved in this classification, and listed on the *Officials Directory* as "r". A Recorded Combined Driving Technical Delegate may officiate alone at any EC-sanctioned Combined Driving Competition offering Training, Preliminary and/or Intermediate division classes only. A Recorded Technical Delegate may not officiate alone at the Advanced division of a Combined Driving Competition. Applicants will be considered for promotion to Senior Technical Delegate after having achieved 'r' status and completing at a minimum of 3 events in the Combined Driving division based on satisfactory evaluations from at least two Combined Driving Advanced Division events while working with a FEI, EC, USEF or ADS Recorded Technical Delegates.
- c) **Learner Combined Driving Technical Delegate** - is an individual who has been accepted into the EC Driving Official Learner Program in this classification. A Learner Combined Driving Technical Delegate may not officiate. They may accompany and monitor only, under the supervision of a Senior Combined Driving Technical Delegate. The purpose of the Learner status is to gain experience, educate and familiarize the Learner with the duties, obligations and requirements of the Combined Driving Technical Delegate and to afford an avenue for advancement and be a prerequisite for advancement to the Recorded status. A Learner may work with the official Technical Delegate

and consult with him throughout the competition. A Learner, if requested, may assist the official Technical Delegate in any way, but has no authority in regard to any decision that has to be made and must not attempt to influence the Technical Delegate's decision. There shall be no limit to the number of times a person may participate as a Learner.

## 2. DUTIES

- a) A Technical Delegate at a given event shall not be a competitor. If management elects to form a type of hearing committee, it is a natural progression to appoint the Technical Delegate to the committee. However, if an appeal is against the decision or action of the Technical Delegate, he must declare a conflict and remove himself from the appeal process for this specific appeal.
- b) A Technical Delegate shall not officiate at any competition in which a member of his family is competing.
- c) Prior to submitting the *Competition Application Form for Driving Events* to the EC Competitions department, the Technical Delegate is responsible for reviewing and signing the Prize List for conformation to these rules. For Events not requiring a Technical Delegate, the review and approval are the responsibility of the Head Judge or most senior EC official involved.
- d) If an emergency necessitates the replacement of a designated Technical Delegate, the above restrictions shall not apply.
- e) Although a Technical Delegate may design or construct a course, the Technical Delegate is not intended to be a Course Designer or a Course Builder. The Technical Delegates primary goal and duty is, and must remain, to assure that a course is constructed in a safe and appropriate fashion and within the framework of the Rules.
- f) A Technical Delegate should clearly understand that he has no authority in connection with the management and judging of any event. He is the representative of Equestrian Canada and should point out in a diplomatic manner any instance where the rules and directives are not enforced. He should not dictate to judges or management, but should immediately report to the appropriate officials any violations of the rules, which might invalidate a class or induce disciplinary action by Equestrian Canada. He should keep himself available to judges, competitors and management at all times to clarify the application of EC rules and investigate any situation in which the rules are not upheld. Additional duties include, but are not limited to, the following:
  - i) To protect the interests of the competitors, judges, and management.
  - ii) To report to the management any misrepresentation or substitution of entry without waiting for a protest.
  - iii) To ascertain that judges either are approved in divisions to which assigned or that the competition has a guest card for the divisions not covered.
  - iv) To measure all animals required to be measured according to the rules.
  - v) To inspect, prior to each class, each obstacle course to insure that the specifications are followed. NOTE: The technical delegate must bear in mind that he has no right to alter a course for aesthetic reasons. Alterations are in order only if the plan violates a specific rule or is clearly undriveable or unsafe.
  - vi) To inspect any marathon course or permanent cross country course at a time early enough to allow any changes or alterations to conform to the

- rules and directives for safety and drivability, to ascertain that any “allowed times” are reasonable considering terrain and weather and supervise the briefing of competitors by the course designer.
- vii) To satisfy himself that all accommodations for horses, if present on the competition site, are adequate and that schooling areas are suitable and safe.
  - viii) To report to the management any offense or violation of the rules and prefer charges against violators if not properly handled by management.
  - ix) To furnish Equestrian Canada with a written report as to the conduct of the event, including any offense or violation of the rules, within fourteen days of its completion, on the forms furnished by Equestrian Canada.
  - x) To inspect all timing equipment assuring that it is in good working order and adequate for specific timing duties; to ascertain that adequate provision has been made for back-up timing during each applicable event and to instruct all timers how the equipment is to be used.
  - xi) To complete evaluation forms for any Learner or Recorded Technical Delegate who is participating, at the competition and mail it to Equestrian Canada.
  - xii) To ascertain that scoring of all competitions is prompt, and that scoring procedures are correct; in particular, that the collection of data, posting of scores and ranking of competitors follows the procedures outlined in the rules.

## **ARTICLE C608 COURSE DESIGNER – COMBINED DRIVING**

### **1. CLASSIFICATION AND DESCRIPTION**

- a) Senior Combined Driving Course Designer - an individual, who has been approved in this classification, is listed in the *Official's Directory* as “S”. A Senior Combined Driving Course Designer is entitled to design for all divisions of Combined Driving competitions.
- b) **Recorded Combined Driving Course Designer** - an individual, who has been approved in this classification, is listed in the *Official's Directory* as an “r”. A Recorded Combined Driving Course Designer is entitled to design for divisions other than Advanced Division Combined Driving Competitions. Applicants will be considered for promotion to Senior Course Designer after having achieved ‘r’ status and completing at a minimum of 3 events in the Combined Driving division based on satisfactory evaluations from at least two Combined Driving Advanced Division events while working with a FEI, EC, or USEF Course Designer.
- c) **Learner Combined Driving Course Designer** – an individual who has been accepted into the EC Driving Official Learner Program. A Learner Combined Driving Course Designer may not officiate. The purpose of the Learner status is to gain experience, educate and familiarize the Learner with the duties, obligations and requirements of the Course Designer and to afford an avenue for advancement and be a prerequisite for advancement to the Recorded status.

### **3. DUTIES**

- a) Responsible for the overall layout of the event under the supervision of the Technical Delegate, including layout for stabling, parking, exercise areas, competition rings, and the design, measurement, supervision of construction and gating for obstacles, the marathon track, and Obstacle competition course.



- b) To provide:
  - i) For Show management’s approval: diagrams and material lists necessary for the construction of all obstacles and courses in sufficient time for their proper construction.
  - ii) For the Technical Delegate: with diagrams of all obstacle courses and marathon maps including their estimated lengths and respective timing requirements, including any alternations planned should ties occur which necessitate a “drive-off”
  - iii) For the Show Secretary: maps, course routes and course designs for posting at proper times.
- c) To oversee the placement of temporary obstacles before each class and insure that each obstacle conforms to the course diagram before each individual round.
- d) To insure that each obstacle conforms to the dimension specifications under these rules.

## ARTICLE C609 DRIVING STEWARDS

### 1. CLASSIFICATION AND DESCRIPTION

- a) **Licensed Steward** - an individual, who has been approved in this classification, is listed in the *Official’s Directory* as “R”, and entitled to steward at all combined driving competitions.

### 2. DUTIES

- a) Goals - goals of stewarding are to HELP, to PREVENT, and to INTERVENE. Stewards represent EC, the event, competitors, officials, the welfare of animals, and drug and medication control.
- b) Purpose of Stewarding – to provide fair sport for all by ensuring:
  - i) safety;
  - ii) welfare of animals;
  - iii) fairness in competition
- c) The process of stewarding is outlined in Article A1317 and in the *FEI Manual for Driving Stewards*, and/or as directed by the President of the Ground Jury.

## CHAPTER 2 –ADVISORY PROCESS

### ARTICLE C610 GUEST CARDS

#### 2. GENERAL:

- a) At the request of the competition management and under extraordinary circumstances, or by reciprocal agreements with USEF and/or ADS, applications for guest cards may be considered by EC.
- b) All requests for guest cards must be sent to Equestrian Canada Competitions Coordinator, Equestrian Canada, on the prescribed form, and a letter explaining why a guest card is required, the qualifications of the person for whom a guest card is being requested, and his or her knowledge of Equestrian Canada Driving Rules.
- c) Applicable fees must accompany the application. The fee will be refunded should the guest card be denied. Licensed officials holding current FEI, USEF or ADS cards in the category requested are exempt from fees for a Guest Card.
- d) All Guest Card applications must be approved by EC and will not be issued to anyone who has unresolved complaints on file from previous events including disregard for EC rules or failure to file required reports in a timely manner.
- e) Only officials licensed by the FEI, USEF, or ADS or by another national federation may adjudicate alone with a Guest Card, subject to a working knowledge of these Equestrian Canada driving rules and possession of a current Rulebook
- f) Permission to officiate shall not be granted to any person more than twice in a particular classification unless the person resides in a foreign country.
- g) The majority of officials for any event should be selected from the EC roster unless sanctioned by the FEI.

#### 3. Guest Judge:

- a) A Guest Judge must be a current member and accredited by the FEI, USEF, ADS or a foreign National Federation and fully familiar with the Equestrian Canada driving rules.
- b) Restrictions of a Guest Judge:
  - i) A competition may request a Guest Card for a non-judge only under extraordinary circumstances such as sudden illness of the already contracted judge or financial hardship due to geographic isolation.
  - ii) Under no other conditions may a Guest Judge officiate alone without special permission of EC.

#### 4. Guest Technical Delegate:

- a) A Guest Technical Delegate must be a current member and accredited by the FEI, USEF, ADS or a foreign National Federation and fully familiar with the Equestrian Canada driving rules.

#### 5. Guest Course Designer:

- a) A Guest Course Designer must be a current member and accredited by the FEI, USEF, ADS or a foreign National Federation and fully familiar with the Equestrian Canada driving rules.

#### 6. Guest Driving Steward:

- a) A Guest Driving Steward must be an accredited Driving Steward by the FEI, USEF or a FEI member national federation.

## **ARTICLE C611 FILING REPORTS**

1. All Event Organizers and officials shall file all applicable post-event reports and evaluations with Equestrian Canada within the specified time limits. Detailed and constructive suggestions are required wherever possible.
2. Event Organizers shall ensure accurate listing of competition results including a minimum of placings, name of Competitors and horses are filed within 14 days following the competition.
3. Licensed Officials who accept Learners at sanctioned events must complete the "Learner Verification" form at the end of the event and return it to the Learner. A separate, confidential evaluation must be completed and forwarded to Equestrian Canada within 14 days of the Competition. These reports assist in determining promotions. All applicant information is confidential.

## **ARTICLE C612 ADVISORY PROCESS**

1. The purpose of the Advisory Process is to keep the standard of officiating at the highest level, to ensure that concerns of competitors are addressed; and to ensure fair competitions.
2. The Advisory Process may be invoked by EC when warranted when:
  - a) Three letters of the same complaint are received by the LOC on the same subject within 5 years;
  - b) One complaint, in writing, of an extremely serious nature is received by the LOC; or
  - c) A series of complaints, in writing, are received by the LOC regarding the same official.

**Note:** A written complaint may be by mail, fax or e-mail and must be dated and signed.
3. Complaints must be investigated, using a reasonable investigation process to make a good faith determination that sufficient cause, based on reasonable grounds, exists to warrant some degree of advisory or disciplinary action. The process must provide for a thorough understanding of all sides of an issue and allow for a structured, measured and fair investigation.
4. If a conflict of interest exists between an individual concerned with investigating a complaint and the individual under investigation, the former will remove him/herself from the process.
5. Complaints will be addressed after sufficient investigation by the LOC as deemed appropriate:
  - a) A verbal advisory warning followed with a summary of the conversation in writing.
  - b) A written advisory warning.
  - c) Non-renewal of licence.
  - d) No action.

## CHAPTER 3 – NON-LICENSED COMPETITION PERSONNEL

### NON-LICENSED OFFICIALS

The successful operation of every show, event or competition requires a number of dedicated individuals to accept the responsibility for various tasks. The following list includes key positions and a general division of responsibilities.

#### ARTICLE C613 Organizing Committee (OC)

The OC is responsible for the pre-event planning, the overall operation including selecting venue, dates, current Licensed Officials, event managers and financial obligations. Additional responsibilities include, but are not limited to:

1. The date application and approval process
2. Obtaining required insurance coverage and permits
3. Obtaining contracts with Licensed Officials, Land Owners and suppliers
4. Appointing event management capable and effective in managing the event
5. Sending the draft Prize List to the Technical Delegate for approval. See *Guidelines-Application for Driving Competitions*. For competitions where a Technical Delegate is not required, the Prize List must be approved by the event's Head Judge or the most senior Judge on the EC roster.
6. Submitting the completed *Competition Application Form for EC-sanctioned Driving Events* with the approved Prize List and Entry form, prior to publication, with applicable fees to Equestrian Canada and copy to the Technical Delegate and President of the Ground Jury at least 60 days in advance of the competition/event.
7. For EC sanctioned events sending the approved Prize List, Entry form and copy of the event permit to EC prior to the event.
8. Ensure all officials officiating under Guest Card privileges have a copy of the EC driving rules immediately following Guest Card approval.
9. Ensuring all post-event reports and obligations are completed in a timely manner.
10. Ensuring document retention. A copy of all original documents such as Entry Forms, waivers, declarations, records of results, accident/incident report, and significant correspondence shall be retained for at least 12 months following the event and made available to Equestrian Canada upon request.
11. Overseeing scheduling. At Combined Driving events, judges may not judge more than eight hours in one day, not including a short morning and afternoon break and a minimum 45-minute break for lunch. A pleasure driving competition may not hold classes more than 16 hours out of any 24 hour period

#### ARTICLE C614 EVENT MANAGEMENT

Event Management is responsible for the effective operation of the event, show or competition including the liaison with licensed officials and competitors, and ensuring compliance with the rules. Management personnel are not permitted to compete, nor serve as a Licensed Official. Additional responsibilities include, but are not limited to:

1. To review Article C108 – *Emergencies* and arrange required services and distribute and post related information as required.
2. Ensure all Licensed Officials are in the current EC Officials Directory or apply for Guest Card under Article C610.
3. To disqualify any competitor who has made an entry of any horse, driver or vehicle that is ineligible.

4. To pay officials and employees fees and other agreed indebtedness by the close of the event.
5. To provide adequate timing equipment, in good working order, for use by the appointed timekeepers.
6. providing qualified medical personnel (as defined by provincial or local regulations, either present or on call (except marathon); a means of communication for accident notification to the central command area; a means of patient retrieval (by stretcher, etc.) from inaccessible areas; and a means of transporting stretcher cases to a hospital. Events that include a marathon or cross-country must provide qualified medical personnel on site (on call for Arena Trials) from the start of the marathon or cross-country until the last horse completes the course;
7. preparing an Emergency Preparedness Plan to address injury of persons or horses and severe weather conditions and to brief all parties mentioned in the plan prior to the start of the event;
8. completing and filing Organizer reports, and ensuring reports for Accident/Injury, Alleged Abuse, Eyewitness and competition results are completed and filed in a timely basis as required.

#### **ARTICLE 615      EVENT OR SHOW SECRETARY**

Event or Show Secretary is directly responsible to Event Management providing liaison with the Competitors and Event Management. Not permitted to compete, nor serve as a Licensed Official. Additional responsibilities include, but are not limited to:

1. Prepare information packages for Licensed Officials and Competitors
2. To obtain and hold required Passports, Health papers for all horse at the event location and disclaimers of liability from all competitors and anyone riding on vehicle or horses while the event is in progress.
3. To assess and collect all non-member fees and verify competitor insurance obligations.
4. To assign and control entry numbers for vehicles and bridle numbers for horses in conjunction with commonly accepted class and scoring procedures
5. To provide officials with means of identification
6. To provide Judges with score cards or dressage tests and scribes
7. To post obstacle course maps and maintain the official notice board
8. To notify competitors and officials at the earliest possible time when schedules are changed or classes added or cancelled.
9. To furnish the Ringmaster with correct ribbons and trophies in time for presentations.
10. Waiver identification: Management shall provide and install a non-transferable wrist bracelet to each person signing the required disclaimers/liability waivers. No person at an EC-sanctioned event shall ride on or in a vehicle anywhere at the event location without such identity readily displayed. Management, officials, or volunteers responsible for safety checks, entrance to competition arenas, and or section starters on the marathon may stop any vehicle with persons not displaying this identification.

## **ARTICLE 616 VETERINARIANS**

Veterinarians are covered under specific rules for Combined Driving and the Veterinary Regulations. In all other cases, the Veterinarian or a qualified associate is on duty or on call during the hours of an event and shall be prepared to handle all duties in the arena or at the event location. The Veterinarian shall assist management in all matters pertaining to the health and welfare of the animals in competition. Unless otherwise stated, his recommendation shall be final for excusing an entry from the event. The Veterinarian's recommendation, if requested by the Judge, shall be final for the purpose of awarding ribbons. If the Veterinarian is not immediately available or not called upon by the Judge, the Judge's decision as to the soundness of a horse shall be final.

## **ARTICLE 617 RINGMASTERS**

Ringmasters are responsible for the conduct of each class during its performance. Duties shall include, but are not limited to:

1. Communication with the paddock marshal and announcer, to ensure all eligible entries are assembled before judging begins
2. Communicate the Judge's directives to the competitors by any efficient means
3. Communicate, by a clearly understandable signal, the start, expiration of time and necessary eliminations during obstacle competitions.
4. Communicate class results to the announcer.
5. Present or supervise the presentation of awards at their proper time to the proper recipients.

## **ARTICLE 618 PADDOCK MARSHALS AND GATE ATTENDANTS**

Paddock Marshals and Gate Attendants are responsible for assisting with the entrance and exit of competitors to their respective classes. Duties shall include, but are not limited to:

1. Coordinate with the Secretary and post an "Order or Go" for each class.
2. Ascertain that all eligible entries are in the arena before judging begins.
3. To keep all access and gate areas clear and expel all unauthorized vehicles, horses, and persons.
4. To take any appropriate action to enhance safety and/or welfare of the horse at all times.

## **ARTICLE 619 TIMEKEEPERS**

Timekeepers are responsible for taking and recording of all times necessary for official placings in each obstacle class and/or marathon. Duties shall include, but are not limited to:

1. Familiarity with timing equipment and correct operational techniques.
2. Report any defective equipment to Management and immediately to the Technical Delegate regarding any suspected inaccuracy or need for corrective action or a technical ruling.

## **ARTICLE 620 SCORER**

The Scorer reports to the Technical Delegate. Responsible for collecting the score cards, dressage tests and observer reports and compiling the scores for the competition. The Scorer must be familiar with these rules and how points are tabulated and classifications made. Discrepancies, questions of interpretation and awarding of additional penalties must be approved by a Judge, member of the Ground Jury or Technical Delegate. Responsibilities include preparation and distribution of clipboards with scoring forms to scribes, timers and observers.

## **ARTICLE 621 SAFETY INSPECTORS**

Safety Inspectors report to the Technical Delegate. Requires a knowledgeable horseman with driving experience to assist drivers with acceptable harnessing and putting to and identifying potential safety problems. Responsible to collect signed a “Safety Checklist” for each turnout departing in a marathon or cross-country. May deny a start to anyone in violation of approved protective headgear regulations; driving an unsafe vehicle, improper or unsafe harness; not filing a required liability waiver or completed *Safety Checklist*; or to any entry with serious safety concerns until such time as the Technical Delegate or Jury member is informed of the situation.

## **ARTICLE 622 PRESENTATION JUDGE**

Presentation Judge reports to the President of the Jury. Requires a working knowledge of turnouts and appointments as well as being a knowledgeable horseman with driving and showing experience. Must be capable of assessing harness and vehicles for safety, cleanliness and suitability and overall impression. Must be able to convey constructive comments to the Competitor.

## PART SEVEN – PARA-DRIVING

### **PREAMBLE**

*Drivers drive at their own risk. Neither the OC nor the FEI accepts responsibility for any accident or illness that may befall any horse, competitor, groom or any other persons. The same applies in the case of damage to carriages harness, equipment, horse boxes, cars and all other objects (including damage by theft, loss and fire).*

*All owners and competitors are personally responsible for damage to third parties caused by themselves, their employees or their horses. They are advised to take out third party insurance and to keep the policy up to date.*

### **CANADIAN ADDENDA**

*Wherever an addition or exception is required under these FEI rules, more specifically to address competition at Training, Preliminary, Intermediate and non-FEI sanctioned Advanced divisions, the text will appear within the article; be identified with the word **Canada** or **Canadian** in bold print; and be written in this style of italic type.*

### **ARTICLE C701 GENERAL**

1. The FEI approves and promotes equestrian competitions on behalf of the International Paralympic Committee (IPC).
2. This FEI Supplement is to be used in conjunction with the current FEI Driving rules and General Regulations.
3. This supplement to the present FEI rules for carriage driving competitions are effective from January 2011. From this date on, all other texts covering the same matter (other editions and all other official documents) issued previously are superseded.
4. Nations are encouraged to organise and attend international competitions and courses.
5. Definitions and the words and phrases shall, where the context permits, have the meanings ascribed to them in Appendix I.
6. Where International competitions are run in conjunction with National competitions, the International and National results must be kept separate.
7. Only competitions officially approved by FEI may use the FEI name for that event.

### **ARTICLE C702 CATEGORIES**

1. Paralympic Games. International Championship organised by a host city in connection with and following the Olympic Games.
2. World Championships. International Championship, open to FEI nations throughout the World.
3. Regional Championships. International Championship restricted to members nations of a particular FEI region. Regional Championships may include open competitions. Regions may combine their Championships.
4. International Competition. International competition with 4 or more nations competing.
5. Local and National. Competitions organised and/or governed by the country's NF or driving for the disabled organisation.

***In Canada, Competitions will be governed by EC at the Training, Preliminary and Intermediate levels.***



6. Regional Championships and World Championships are Major Championships. All Major Championships must be approved by FEI. Entries for Major Championships may be limited by FEI or the host city/nation.  
*In Canada, Regional Championships offering Training, Preliminary and Intermediate will be governed by EC.*
7. All International Competitions shall be approved by FEI.  
*In Canada, International competitions offering Training, Preliminary and Intermediate will be governed by EC.*
8. Invitational Competitions. International and Regional Championship competitions that are limited to specific nations (e.g. Pacific Rim or European).
9. Where possible, nations should enter drivers from both Grades.
10. Competitions may be open to all people with disabilities that are eligible by FEI rules, or restricted to specifically invited nations or group of individuals (refer to FEI Classification Manual).
11. Dates of FEI competitions and training courses are published in the FEI Equestrian Calendar, on the FEI website [www.fei.org](http://www.fei.org).

### **ARTICLE C703 OBJECTIVE**

1. The FEI resolves to provide competition opportunities for equestrian athletes with disabilities, to achieve their personal best performance in their chosen discipline.
2. The object of carriage driving is to improve balance, control, mobility, general fitness, memory and freedom.
3. **FEI CODE OF CONDUCT**
  - 3.1 FEI Code of Conduct must be adhered to.
  - 3.2 In all equestrian sports, the welfare of the horse must be considered paramount. In the interest of the horse, the fitness and competence of the driver must be taken into consideration.

### **ARTICLE C704. REQUIREMENTS FOR ORGANISING COMPETITIONS**

1. **SANCTIONING AND APPROVAL**
  - 1.1. Major Championships. Shall be officially approved by the FEI. The Organising Committee (OC)'s National Equestrian Federation must seek request for sanctioning and approval.
  - 1.2. Invitations shall not be sent until the FEI has approved the Schedule.
  - 1.3. For a Major Championship to receive sanctioning from FEI an official Bid Document must be obtained from, completed and submitted by the respective National Federation to the FEI. A site visit by FEI officials may be required. Expenses for the site visit shall be borne by the nation submitting the Bid.
  - 1.4. There must be an OC consisting of suitably experienced people, who will organise the competition and liaise with FEI.
  - 1.5. A representative nominated by FEI shall attend all competitions sanctioned by FEI. This representative may fulfil other duties at the competition. All expenses of this representative must be met by the organising committee.
2. **INVITATIONS**
  - 2.1. Invitations for Major Championships shall be sent as early as possible in the relevant year. Invitations for other competitions shall be sent as early as possible but in any case at least 4 months before the competition to allow for fund-raising and planning.
  - 2.2. The OC shall send a Letter of Confirmation (containing such information as the FEI shall from time to time require) to all the NFs that have entered the competition.

## **ARTICLE C705 ELIGIBILITY**

1. Qualification for entry in a Major Championship must be decided by the NF.
2. Major Championships Drivers may compete from the beginning of the year in which they reach their 16th birthday for singles and 18th birthday for pairs.  
*In Canada, there is no minimum age for drivers at the Training, Preliminary levels, however, a driver under the age of 14 yrs must be accompanied by a knowledgeable adult horseman capable of rendering assistance in an emergency.*
3. For International competitions, a competitor or horse that has been withdrawn from competition due to medical reasons may be re-entered into the competition with the permission of the Technical Delegate and the OC, with submission of certification from either the Medical Delegate or the Veterinary Delegate, as relevant, that the driver or horse is again fit to compete.
4. A driver may enter a higher Grade than his classification indicates.
5. A driver may not enter a lower Grade than his classification indicates.
6. If the Grades are combined in the same class all drivers will compete against each other.
7. Teams and individual drivers are required to provide their own necessary personal support staff in order for them to compete. The OC is not responsible for providing staff or helpers for competitors or grooms for the horses.

## **8. DOPING AND USE OF DRUGS FOR DRIVERS and HORSES**

- 8.1. The FEI forbids competitors the use of banned substances to enhance performance. Competitors may be subject to random doping tests both in and out of competition. Any competitor guilty of using any banned substance will be disqualified from all competitions associated with the event. All competitors participating in FEI sanctioned events agree by their entry and participation to adhere to the provisions, rules and regulations outlined in the current FEI Medical and Anti-Doping Code.
  - 8.2. Other than when administered in the event of an emergency by or on the orders of a registered medical practitioner or a member of the official medical team, no driver may be given any drug, including the administration of oxygen, morphine, etc. whilst he is in the main competition area before, during or after the conclusion of the competition. (For further information contact FEI or driver's NF).
  - 8.3. All drugs and medicines used by drivers must be declared on the entry form, unless registered with FEI through the Medication Advisory Panel (M.A.P.). Teams may register the drugs and medications taken by their drivers with FEI Headquarters in accordance with the procedures outlined in the current FEI Medical and Anti-Doping Code (WADA).
  - 8.4. Horses/ponies may be dope tested.
- ## **9. SUBSTITUTION OF DRIVERS and/or HORSES**
- 9.1. Major Championships, after the Closing of Definite Entries and prior to declaration of the team members a driver may be substituted by another driver of the same Grade. A medical doctor's certificate stating the illness or injury incurred by the original team member must be submitted to the OC and that the substitution does not alter the composition of the team (See Rule 6.1).
  - 9.2. Substitution of horses: see FEI driving rules. Art. 921.
  - 9.3. At all other competitions, in the event of a driver becoming unable to compete from the final entry to the start of the competition, a substitution of a driver or horse and driver from the same nation and the same or a different Grade may

be approved by the OC provided such horse(s) or Driver(s) are shown on that Nation's Nominated Entry list.

## **ARTICLE C706 TEAMS**

1. A Team is comprised of 2 or 3 drivers and horses and must include at least one driver from Grade I. Teams should not include more than 2 drivers from any one Grade.
2. Each competing nation may enter the Team competition providing it complies with the above Rule. The team is determined by adding together the scores of the best 2 competitors in each national team with the least number of penalties in each Competition. Only the scores of those team members who have completed all 3 Competitions can be counted towards the final team scores (see FEI article 925).

## **ARTICLE C707 OFFICIALS**

### **1. GENERAL**

- 1.1. Major Championships. FEI is responsible in conjunction with the OC for appointing the Technical Delegate(s), Classifiers, Ground Jury, Jury of Appeal and Chief Steward. FEI is also responsible for appointing the FEI Representative.
- 1.2. For International Competitions, The FEI is responsible for appointing the FEI Representative and/or the Technical Delegate or Technical Advisor as relevant. For smaller international competitions, the same person may hold one or more positions.
  - 1.2.1. *In Canada, the ground jury is appointed by the OC at non-FEI competitions*
- 1.3. The OC is responsible for the travel expenses of all FEI appointed officials from the officials' home address, accommodation, food and transport for transfer from the place of arrival and departure and to and from the accommodation and the venues.
  - 1.3.1. *In Canada, the OC is responsible for the travel expenses of all appointed officials from the official's home address, accommodation, food, and transport for transfer from the place of arrival and departure and to and from the accommodation and the venues.*
- 1.4. The OC should inform the officials of all arrangements made on their behalf at least three weeks prior to the competition. Officials may also make their own arrangements for travel, and be reimbursed by the OC.

## **ARTICLE C708 APPOINTMENT AND RESPONSIBILITIES**

### **1. TECHNICAL DELEGATES**

- 1.1. Major Championships. A Technical Delegate, with an assistant if deemed necessary by FEI or OC, shall be appointed by FEI.
- 1.2. Other competitions shall have one Technical Delegate appointed by FEI.
- 1.3. For smaller competitions, a Technical Advisor may be appointed.
- 1.4. At least one Technical Delegate should be in attendance at meetings of the Jury of Appeal, and may call such a meeting.
  - 1.5. *In Canada, all competitions will have 1 TD selected by the OC.*

### **2. TECHNICAL ADVISER**

- 2.1. For Invitational Championships and small International competitions, one person may be appointed by FEI in conjunction and consultation with the OC as a joint Technical Delegate and President of the Jury of Appeal. This person shall be known as a Technical Adviser. This person may also be the official FEI representative.

3. **CLASSIFIERS**

- 3.1. Major Championships. At least 2 international FEI Status Classifiers from different nations shall be appointed by FEI.
- 3.2. For International competitions the OC, in consultation with FEI, shall appoint at least two classifiers of different nationalities, with one of these classifiers being of international FEI status.
- 3.3. International and National classifiers are encouraged to observe at both International competitions and Major Championships.

4. **GROUND JURY (JUDGES)**

- 4.1. Major Championships. The Ground Jury shall be appointed by FEI and FEI shall appoint the President of the Ground Jury at least three months prior to the event.
- 4.2. For International competitions, the OC, in consultation with FEI shall appoint the Ground Jury.
- 4.3. The Ground Jury shall consist of FEI accredited judges.
- 4.4. *In Canada, the Ground Jury will be appointed by the OC for non FEI competitions.*

5. **COURSE DESIGNER**

- 5.1. Major Championships. The Course Designer shall be appointed by the FEI.
- 5.2. For International competitions the OC in consultation with FEI, shall appoint the Course Designer.
- 5.3. The Course Designer is responsible for the Dressage, Marathon and Obstacle Driving Courses.
  - 5.3.1. *In Canada, the Course Designer will be appointed by the OC at non FEI events.*
- 5.4. The Course designer together with the Technical Delegate is responsible for conducting a tour of the Marathon Course and obstacles for all competitors.

6. **CHIEF STEWARD**

- 6.1. Major Championships. The Chief Steward shall be appointed by FEI.
- 6.2. For other competitions, the OC, in consultation with FEI, shall appoint a suitably qualified person for this position.
- 6.3. The Chief Steward has the overall responsibility and control of the horses, carriages and harness including the application of special equipment rules, regulating and organising the duties of the stewards appointed by the OC and for overseeing the Stable Manager(s). The Chief Steward shall liaise with the Technical Delegate and other officials as necessary.

7. **JURY OF APPEAL**

- 7.1. Members of the Jury of Appeal must have appropriate experience. They must be available at the venue throughout the competition.
- 7.2. Major Championships. The Jury of Appeal and its President shall be appointed by FEI.
- 7.3. At every international competition, there shall be a multi-national Jury of Appeal. The President will be appointed by FEI and 2 members appointed by the OC in conjunction with FEI.
  - 7.3.1. *In Canada, the Jury of Appeal is appointed by the OC in conjunction with EC or CPEC.*
- 7.4. For all other competitions, the OC shall appoint the Jury, in consultation with FEI.
  - 7.4.1. *In Canada, for all other competitions, the OC shall appoint the Jury.*

**ARTICLE C709 VETERINARY INSPECTIONS**, examinations and identification (FEI art: 922)

1. All horses must pass a veterinary inspection upon their arrival. The Veterinary Delegate shall perform this inspection.  
*In Canada, the first examination is not required.*

**ARTICLE C710 OTHER REQUIREMENTS FOR ORGANISING COMMITTEES** (see FEI guidelines for organisations and officials)

1. Other requirements for holding an FEI International Equestrian Competition for drivers with disabilities include the following:
  - 1.1. Scoreboard and Score Board attendant. The Scoreboard shall be of a size and in location where it is easy to read both standing and from a wheelchair.
  - 1.2. Transport Manager with drivers and suitable vehicles for transporting riders, sponsors and officials and for emergency vehicles.
  - 1.3. Wheelchair accessible ramps for all facilities used by competitors.
  - 1.4. A convenient area and table for the IPEC Information Stand, which also sells relevant articles. The IPEC Secretary shall be consulted on this matter.
2. **EQUIPMENT FOR OFFICIALS AND STAFF**
  - 2.1. The current Supplement for carriage driving, the FEI driving Rule Book, the FEI Classification Manual and FEI General Regulations must be available in a convenient area for officials' use.
3. **ADVERTISING**
  - 3.1. The OC or their designated Press officer shall be responsible for promoting the competition.
  - 3.2. All materials published about the competition shall incorporate the term "International Para-Equestrian", FEI and the name of the country hosting the competition and the venue.
  - 3.3. It is recommended that national and local media be sent a press release in English and in the host nation's language no less than 6 weeks prior to the competition. This press release shall also be sent to each participating nation's NF.

**ARTICLE C711 COMPETITION STANDARDS AND PROCEDURES**

**1. INTERNATIONAL COMPETITIONS**

- 1.1. With the following exceptions, the current FEI Rules for Driving Events CAI category B for singles and pairs horses, and singles and pairs ponies and the relevant Rules in the FEI supplement for Para-Equestrian Carriage Driving, will apply for International Competitions for disabled carriage drivers from 1 January 2011.

**2. DRIVERS**

- 2.1. Carriage Driving competitions are for drivers with their own turn-out.
- 2.2. Drivers may make their own arrangements to borrow horses. The OC will advise.
- 2.3. The nation/driver using a horse/pony loaned by the host is responsible for all expenses associated with that horse/pony.

**3. CLASSES**

- 3.1. There should be separate classes for Singles and Pairs. Any other categories are not allowed. A class must have at least 4 entries.
- 3.2. Grade I drivers and Grade II drivers shall be in separate classes unless the number of entries is 3 or less, in which case the Organising Committee and the

Technical Delegate may allow the classes to be merged. If possible, the competitors will be informed before they arrive at the venue.

#### **4. COMPETITORS**

- 4.1. Only those disabled competitors who are capable of driving Dressage Tests, Cones Courses and Marathons independently and to the FEI rules are allowed to compete.
- 4.2. The competitors shall be classified according to FEI rules for carriage driving. The Profile and Grade shall be noted on the entry form, programme and score board.
- 4.3. The event Organiser and Technical Delegate have the right to refuse entry but they must give the reason for the refusal in writing.

#### **5. HORSES**

- 5.1. Competitors may use either a horse or a pony. It must be stated on the entry form which will be used.
- 5.2. All foreign horses must comply with the host nation's veterinary requirements.
- 5.3. All horses at all times must be under supervision of an official of the OC.
- 5.4. Major Championships. Once a horse has been accepted onto the competition venue, it must at all times remain at the competition venue for the entire period of the competition. It may not leave the venue without the permission of the OC and the Technical Delegate.
- 5.5. All horses will be allocated a number which will be displayed prominently on the stable door and on the horse at all times. The number will be prefixed by the Grade of the driver e.g. horse number 20 driven by a Grade II driver, becomes number 220. Organisers may opt for name badges for the drivers, able-bodied Whips, grooms and team officials.

#### **6. GENERAL**

- 6.1. All exceptions to dress, special equipment, compensating aids and other assistance required by the driver shall be clearly listed on the driver's FEI Card.
- 6.2. Use of any equipment, or exemption, that has not been sanctioned by FEI must be supported by medical documentation and approved by the Chief Classifier. Such exceptions shall be clearly listed on the Driver Profile form and Entry form at the time of entry.

#### **7. VEHICLES**

- 7.1. Vehicles suitable for the disabled driver must be used.
- 7.2. Vehicles for Singles may be 2 or 4-wheeled.
- 7.3. Pneumatic tyres are permitted.
- 7.4. The Organising Committee or Technical Delegate may refuse the use of a vehicle, but must give the reason for the refusal.
- 7.5. The carriage may or may not be fitted with lamps, rear lights or reflectors in competitions A and C. Reflectors must be correctly fitted to all Marathon carriages.
- 7.6. *In Canada, vehicles used in Dressage and Cones with lamp brackets must be fitted with carriage lamps. Red reflectors must be fitted on all vehicles unless the vehicle is fitted with a rear lamp. In addition to reflectors, slow moving vehicle signs may be required by local municipal regulations. The organizer may waive the requirement for reflectors at divisions other than advanced provided no public roads or local bylaws would be violated and notice is published in the prize list.*
- 7.7. Track widths for Dressage and Cones - as FEI Article 918.1.1. For Marathon – see Article 918.1.2.

#### **8. HARNESS**

- 8.1. Driving with a second set of reins or divided reins is not allowed.
- 8.2. *In Canada, a second set of reins or divided reins may be used in the Training, Preliminary and Intermediate levels.*

## 9. ASSISTANCE

- 9.1. The ultimate responsibility regarding the use of permitted assistance lies with the driver.
- 9.2. CD Grade I drivers must have an able-bodied Whip on the carriage at all times. A groom must be available at the ring side to assist every Grade 1 competitor in Dressage and Cones.  
A Groom may accompany a Grade 1 driver in Marathon either in the carriage or following behind the carriage on a bicycle. In Section B of Marathon all Grade 1 competitors must be accompanied by an additional groom either in the carriage or following by a team member behind the carriage on a bicycle, moped, ATV (quad bike) or similar. Team members on bicycles or mopeds etc. are not permitted to drive through the obstacles but must wait for the competitor to complete the entire obstacle before proceeding.  
Team members may only act in case of emergency and this will be punished as outside assistance. Grooms may act as a groom and will be punished like a groom.
- 9.3. Able-bodied Whips are forbidden to assist in rein handling except in an emergency when help must be given in the interest of safety. Assistance by handling the reins will incur 20 penalty points each time.
- 9.4. Grade II drivers may put down the able-bodied Whip if necessary but penalties will be incurred as per FEI regulations. In competitions A and C the able-bodied Whip must sit so that he/she can help in case of need. The event Organiser or the Technical Delegate has the right to disapprove of an able-bodied Whip or his/her position on the vehicle.
- 9.5. Drivers may inspect the course in motorised quad bikes or similar if sanctioned by FEI.

## 10. COMPENSATING AIDS AND SPECIAL EQUIPMENT

- 10.1. Only approved special equipment that is listed on the FEI card may be used for the duration of the competition, including the training period.  
*In Canada, only approved special equipment/aids that are listed on the driver's classification card may be used for the duration of the competition, including the training period.*
- 10.2. If the competitor wishes to drive in a wheel-chair, the wheel chair must be secured. Straps and clamps for the wheelchair must be of a „quick release“ variety.
- 10.3. In the interests of safety, sloping cushions, shell seats, waist high seat sides and arm-rests are permitted. In order to have more upper body support a strap (or similar) held around the driver is permitted as long as this in no way attaches the driver to the carriage by any technical means or in the manner that it is held.
- 10.4. Supporting aids may be considered for approval by the TD and the PGJ at the Veterinary Inspection that takes place before the start of the competition.
- 10.5. Reins may not be attached to the driver in any manner that could prevent the driver from falling free from the carriage.
- 10.6. The disabled competitor may drive with one or 2 hands and with looped reins or any other aids with which he/she normally drives and which is approved by FEI.  
*In Canada, the disabled competitor may drive with one or two hands and with looped reins or any other aids that are listed on the driver's classification card.*
- 10.7. The driver may salute with the head only so that contact is maintained on the reins at all times.

- 10.8. The whip may be used by either the disabled competitor or the able-bodied Whip in all competitions if this has been sanctioned by FEI.

*In Canada, the whip may be used by either the disabled competitor or the able-bodied Whip in all competitions if this has been sanctioned by the NF.*

- 10.9. The brake may be used by the groom or converted to a hand brake to be used by the driver if sanctioned by FEI. Use of the brake by the groom will be punished by 20 penalty points each time.

*In Canada, the brake may be used by the groom or converted to a hand brake to be used by the driver if sanctioned by the NF. Use of the brake by the groom will be punished by 20 penalty points each time.*

## ARTICLE C712 THE COMPETITION

### 1. PRESENTATION AND DRESSAGE

- 1.1. Presentation will be judged on the move.  
1.2. The Dressage test will be advised by the OC and approved by FEI (see Appendix).

*In Canada, the dressage test will be advised by the OC.*

### 2. THE MARATHON

- 2.1. The marathon will be divided into 3 sections. Section A, Walk, B.

Section	Maximum Distance	Pace	Maximum Speed	
			Horse	Pony
A	6 km	Any pace	15 km/h	14 km/h
D	1 km	Walk	7 km/h	6 km/h
E	8 km	Any pace*	14 km/h	13 km/h

\* After last obstacle or last 300m, FEI Article H960.6

- 2.2. The total length of the Marathon course shall not exceed 15km. Courses should be designed for the standard of driving expected.  
2.3. There may not be more than 6 obstacles in section B.  
2.4. A safety check of the turnout must be made before the start of Marathon and during the 10 minute hold before the start of section B.

*In Canada, a safety check of the turnout must be made before the start of Marathon. An additional safety check may be conducted during the 10 minute hold before the start of Section B at the discretion of the OC.*

- 2.5. A Safety Headgear is required to be worn by all persons on the carriage throughout Section B.

*In Canada, properly fitted, securely fastened, approved protective headgear (see Glossary – Headgear Standards) is required for all persons riding on a carriage at all times at the event location. A protective vest and medical armband are strongly recommended.*

### 3. CONE DRIVING

- 3.1. The time allowed will be calculated for a speed of 210 m/min for both horses and ponies. For drive-offs a speed of 220 m/min may be used.

*In Canada, speeds for divisions other than advanced (in meters/minute)*

Division	Class	Single/Pair	Tandem / Four-in-hand
Training	VSE	160 mpm	150 mpm



	<i>Horse/Pony</i>	<i>180 mpm</i>	<i>170 mpm</i>
<i>Preliminary</i>	<i>VSE</i>	<i>180 mpm</i>	<i>170 mpm</i>
	<i>Horse/Pony</i>	<i>200 mpm</i>	<i>190 mpm</i>
<i>Intermediate</i>	<i>VSE</i>	<i>190 mpm</i>	<i>180 mpm</i>
	<i>Horse/Pony</i>	<i>220 mpm</i>	<i>210 mpm</i>

### ARTICLE C713 AWARDS

1. **Major Championships.** For prize-giving ceremonies competitors shall enter the arena in their carriages.
2. Carriages shall be accompanied by the Chefs d'Equipe of the nations or their representatives, who must be correctly attired. Horse owners may also accompany their horses, correctly attired.
3. For International competitions, the O.C. shall determine appropriate awards and award ceremonies using the FEI rules for guidance. The number of prizes awarded for each competition must be allocated on the basis of at least one prize for every 4 starters, with a minimum of 3 prizes. The OC may, at their discretion, award prizes in kind in addition to rosettes, etc.
4. It is recommended that medals and rosettes are awarded to the individual competitors placed 1st, 2nd and 3rd in all sections of the competition, to each member of the teams placed 1st, 2nd and 3rd, and to the overall Champion and those placed second and third in each Grade.
5. In all competitions, rosettes will also be awarded to the individual competitors and to each team member placed 4th to 8th.
6. For competitors using Borrowed Horses, and for those Horses not actually owned by the driver, additional identical rosettes or similar memento shall be awarded to the owners of horses placed 1st-8th.
7. Except in the event of a tie, in no case shall more than 3 medals be presented in respect of any one section in any competition. Where there is equality of points, equal placings shall be awarded and shall each receive the appropriate prize or medal.
8. Participants' rosettes or medallions will be awarded to all competitors and horse owners including reserve horses.
9. If possible Sponsors or their representatives should present the prizes.

### ARTICLE C714 CLASSIFICATION - ASSESSMENT OF FUNCTIONAL ABILITY

1. After the closing date of entries, the OC. shall send to the FEI Chief Classifier (c/o the FEI Secretariat) a list of all drivers with their nation, their Profile Number and the Grade that they are entered. The list will be checked and returned to the OC, verifying those that are already classified and a list of those that need to be classified, or re-examined.

*In Canada, after the closing date of entries, the OC may send to the NF Chief Classifier (c/o the NF Secretary) a list of all drivers with their nations, their Profile Numbers and the Grades that they are entered. The list will be checked and returned to the OC, verifying those that are already classified and a list of those that need to be classified or re-examined.*

2. For classification procedure see FEI Para Equestrian Generic Rules.
3. All International Carriage Drivers shall hold an FEI card (also known as an ID Card) which lists their Profile number, Grade, Nation, International Number and the Compensating Aids and equipment which may be used.

*In Canada, all Para drivers shall hold a NF cards (also known as ID cards) which lists their Profile Numbers, Grade and the Compensating Aids and equipment that may be used.*

4. Drivers are divided into 2 Grades: Grade II drivers have greater functional ability than Grade I drivers
5. The FEI will issue the driver with an FEI Card on which his/her permitted compensating aids are listed.

*In Canada, the NF will issue the driver with a NF card on which his/her permitted compensating aids are listed.*

6. The FEI Card must be carried by the driver at all FEI competitions in which they are entered.

*In Canada, the NF card must be carried by the driver at all competitions in which he/she is entered.*

7. Any protests to a driver's classification are to be dealt with in accordance with FEI procedures. Refer to the FEI Classification Manual.
8. The driver's own NEF may also give permission to the driver to use this card and the compensating aids listed on it to compete in national competitions for able bodied drivers.

## APPENDIX 7-A - DEFINITIONS AND INTERPRETATION

<b>Able-bodied Groom Classification</b>	An experienced driver of 18 years or over. The process in which a driver is evaluated and assigned a Functional Profile and Grade.
<b>Classifier</b>	Medical doctor and/or physiotherapist with knowledge of the Profile System who are accredited by FEI to grade drivers for competition and who is accredited.
<b>Compensating Aids</b>	Special allowances listed on the driver's FEI Card. <i>In Canada, special allowances listed on the drivers NF card.</i>
<b>FEI Card</b>	Card issued to a classified driver which lists their Functional Profile, Grade, sanctioned special equipment and compensating aids
<b>National Equestrian Federation</b>	The national organization of each nation recognised by FEI as that nation's governing body for equestrian sport for riders and drivers with disabilities.

## APPENDIX 7-B - FEI DRESSAGE TEST NO. 4 PE

### DRESSAGE TEST NO 4 For Carriage Drivers with Disabilities

Arena 100m (80m) x 40 m

Scheduling interval: 9 minutes

Competitor's No ..... Name..... Nation ... Grade....

		Movement	To be judged	Mark	Remarks
1	A X	Enter in working trot Halt. Salute	Regularity and freedom Transition Standing straight,		
2	XCMB BX XM	Working trot Half circle right 20m Return to track at M	Impulsion, regularity Accuracy of figure Bending		
3	MCHE EX XH HCMR	Working trot Half circle left 20m Return to track at H Working trot	Impulsion, regularity Accuracy		
4	RXV VKAD	Extended trot Working trot	Transition, extension, Impulsion and regularity. Transition		
5	D DKD DFD	Collected trot Circle left 20 m followed immediately by Circle right 20m	Transition, regularity Accuracy of figure. Regularity, impulsion and bending		
6	DX X	Walk Halt. Immobility 10 sec Rein back 3 m	Transition to walk Immobility, obedience Straightness		
7	XGCM R RBXE V	Working trot Walk	Transitions Impulsion, regularity		
8	VKAF P PXS	Working trot Extended trot	Transition to working trot Extension, regularity		
9	SHCM MSBV FAD	Working trot Serpentine of 5 loops - 20m each turn (3 loops in small arena)	Transition to working trot Accuracy of figure Regularity		
10	DG G	Transition, extension Standing on the bit	Extended trot Progressive halt Salute		
11	Paces	Regularity and freedom			
12	Impulsion	Free forward movement			
13	Obedience and lightness	Response to aids, willingness and without resistance			
14	Driver	Use of aids Accuracy of figures			
15	Presentation	Appearance of driver and groom. Cleanliness and fit and harness and vehicle. Condition of horse.			

**Scale of marks**

10 Excellent	4 Insufficient
9 Very good	3 Fairly bad
8 Good	2 Bad
7 Fairly good	1 Very bad
6 Satisfactory	0 Not performed
5 sufficient	

**Errors of course and dismounting of grooms are penalised as follows:**

- 1st incident = 5 penalties
- 2nd incident = 10 penalties
- 3rd incident = 15 penalties
- 4th incident = Elimination

Penalties (President’s sheet only) .....

**Signature of Judge** ..... **at** .....

**Signature of President of Jury**.....

Copyright © FEI Para – Equestrian 2006

## APPENDIX 7-C - ADDENDUM FOR PARA-EQUESTRIAN DRIVING

<p><b>Principle</b></p>	<p>Competitions may be open to all people with disabilities that are eligible by FEI rules, or restricted to specifically invited nations or group of individuals (refer to FEI Classification Manual).</p> <p>The Classification is the process in which an Athlete is evaluated and assigned a Functional Profile and Grade. The Assessment is conducted by a Classifier, who is a Medical doctor and/or physiotherapist with knowledge of the Profile System who are accredited by FEI to grade PE Athletes for competition and who is accredited.</p> <p>Each PE Athlete is issued an FEI Card which lists their Functional Profile, Grade, sanctioned special equipment and compensating aids (special allowances).</p> <p>After the closing date of entries, the OC shall send to the FEI Chief Classifier (c/o the FEI Secretariat) a list of all Athletes with their nation, their Profile Number and the Grade that they are entered. The list will be checked and returned to the OC, verifying those that are already classified and a list of those that need to be classified, or re-examined.</p> <p>For classification procedure see FEI Para Equestrian Generic Rules.</p>
<p><b>Grades</b></p>	<p>Athletes are divided into 2 Grades: Grade I and Grade II Grade II Athletes have greater functional ability than Grade I PE Athletes.</p>
<p><b>FEI Card</b></p>	<p>The FEI will issue the Athlete with an FEI Card on which his/her permitted compensating aids are listed.</p> <p>All Athletes shall hold an FEI card (also known as an ID Card) which lists their Profile number, Grade, Nation, International Number and the compensating aids and equipment which may be used</p> <p>The FEI Card must be carried by the Athlete at all FEI competitions in which they are entered.</p> <p>Any protests to a Athlete's classification are to be dealt with in accordance with FEI procedures. Refer to the FEI Classification Manual.</p> <p>The Athlete's own NF may also give permission to the Athlete to use this card and the compensating aids listed on it to compete in national competitions for able bodied Athletes.</p> <p>All exceptions to dress, special equipment, compensating aids and other assistance required by the Athlete shall be clearly listed on the Athlete's FEI Card.</p> <p>Use of any equipment, or exemption, that has not been sanctioned by FEI must be supported by medical documentation and approved by the Chief Classifier. Such exceptions shall be clearly listed on the Athlete Profile form and Entry form at the time of entry.</p>

<b>Classes</b>	<p>A PE Athlete may enter a higher Grade than his classification indicates.</p> <p>A PE Athlete may not enter a lower Grade than his classification indicates.</p> <p>Grade I Athletes and Grade II Athletes shall be in separate classes.</p>
<b>Eligibility</b>	<p>Only those disabled Athletes who are capable of driving Driven Dressage Tests, Cones and Marathons independently and to the FEI rules are allowed to compete.</p> <p>The Profile and Grade shall be noted on the entry form, programme and score board.</p> <p>The event Organiser and Technical Delegate have the right to refuse entry but they must give the reason for the refusal in writing.</p>
<b>Drugs and Medicines</b>	<p>All drugs and medicines used by Athletes must be declared on the entry form, unless registered with FEI through the Medication Advisory Panel (M.A.P.). Teams may register the drugs and medications taken by their Athletes with FEI Headquarters in accordance with the procedures outlined in the current FEI Medical and Anti- Doping Code (WADA). 5.9.4 Horses/ponies may be dope tested.</p>
<b>Entries World Driving Singles Championship for Para-Equestrian</b>	<p>Each NF may enter a maximum of six Single PE Athletes with a maximum of two Horses per entry on the Nominated Entry List and three Single PE Athletes with a maximum of one Horse per PE Athlete on the Definite Entry List.</p> <p>Each team must include at least one (1) Athlete from Grade I.</p> <p>Should a NF only be able to send two PE Athletes, they must be entered as a team.</p> <p>Each NF is entitled to send a Chef d'Equipe and Veterinarian, both of whom will be accorded the same privileges as the PE Athletes.</p> <p>A NF which cannot send a team may enter one PE Athlete as an Individual under the conditions set out in Article 912.</p> <p>A spare Horse from the Nominated List may be entered per national team. The PE Athlete who uses the spare Horse will be eligible for the individual classification, as well as for the team classification. The spare Horse can only be substituted once, not later than one hour before the start of Driven Dressage and notified in writing to the Organiser.</p>
<b>Additional requirement for OCs</b>	<p>Scoreboard and Score Board attendant. The Scoreboard shall be of a size and in location where it is easy to read both standing and from a wheelchair.</p> <p>Transport Manager with Athletes and suitable vehicles for transporting riders, sponsors and officials and for emergency vehicles.</p> <p>Wheelchair accessible ramps for all facilities used by Athletes.</p> <p>A convenient area and table for the IPEC Information Stand, which also sells relevant articles. The IPEC Secretary shall be consulted on this matter.</p>
<b>Horses</b>	<p>PE Athletes may use either a horse or a pony. It must be stated on the entry form which will be used.</p>

<p><b>Assistance</b></p>	<p>The ultimate responsibility regarding the use of permitted assistance lies with the PE Athlete.</p> <p>Grade I Athletes must have an able-bodied whip on the carriage. A Groom must be available at the ring side to assist every Grade 1 PE Athlete in Driven Dressage and Cones.</p> <p>A Groom may accompany a Grade 1 PE Athlete in Marathon either in the carriage or following behind the carriage on a bicycle. In Section B of Marathon all Grade 1 PE Athletes must be accompanied by an additional Groom either in the carriage or following by a team member behind the carriage on a bicycle, moped, ATV (quad bike) or similar. Team members on bicycles or mopeds etc are not permitted to drive through the obstacles but must wait for the PE Athlete to complete the entire obstacle before proceeding.</p> <p>Team members may only act in case of emergency and this will be sanctioned as outside assistance. Grooms may act as a groom and will be sanctioned like a groom.</p> <p>Able-bodied Whips are forbidden to assist in rein handling except in an emergency when help must be given in the interest of safety. Assistance by handling the reins will incur 20 penalty points each time.</p> <p>Grade II Athletes may put down the able-bodied Whip if necessary but penalties will be incurred as per FEI regulations. In Driven Dressage and Cones the able-bodied Whip must sit so that he/she can help in case of need. The event Organiser or the Technical Delegate has the right to disapprove of an able-bodied Whip or his/her position on the vehicle.</p> <p>PE Athletes may inspect the course in motorized quad bikes or similar if sanctioned by FEI.</p>
<p><b>Compensation Aids and special equipment</b></p>	<p>Only approved special equipment that is listed on the FEI card may be used for the duration of the competition, including the training period.</p> <p>If the PE Athlete wishes to drive in a wheel-chair, the wheel chair must be secured. Straps and clamps for the wheelchair must be of a 'quick release' variety.</p> <p>In the interests of safety sloping cushions, shell seats, waist high seat sides and arm-rests are permitted. In order to have more upper body support a strap (or similar) held around the Athlete is permitted as long as this in no way attaches the Athlete to the carriage by any technical means or in the manner that it is held. A PE Athlete may be attached for support, but must have a method for quick release.</p> <p>Supporting aids may be considered for approval by the TD and the PGJ at the Veterinary Inspection that takes place before the start of the competition.</p> <p>Reins may not be attached to the PE Athlete in any manner that could prevent the PE Athlete from falling free from the carriage. The disabled PE Athlete may drive with one or 2 hands and with looped reins or any other aids with which he/she normally drives and which is approved by FEI.</p>



	<p>The PE Athlete may salute with the head only so that contact is maintained on the reins at all times.</p> <p>The whip may be used by either the PE Athlete or the able-bodied Whip in all competitions if this has been sanctioned by FEI.</p> <p>The brake may be used by the groom or converted to a hand brake to be used by the PE Athlete if sanctioned by FEI. Use of the brake by the groom will be punished by 20 penalty points each time.</p>
<b>Cones</b>	<p>The time allowed will be calculated for a speed of 210 m/min for both horses and ponies. For drive-offs a speed of 220 m/min may be used.</p>

**PART EIGHT - RESERVED FOR FUTURE USE**

## PART NINE - RULES FOR COMBINED DRIVING COMPETITIONS

### Preamble

This edition of the FEI Driving Rules comes into force on January 1, 2022. As from the aforementioned date, all other texts covering the same matter (other editions, and all other official documents) issued previously are superseded.

Although this booklet sets out the detailed Rules of the FEI governing International Driving Events, it must be read in conjunction with the Statutes, the General Regulations, the Veterinary Regulations as well as all other FEI Rules and Regulations.

Not every eventuality can be provided for in these Rules. These Rules are supplemented by a “Notes for Guidance” document published and updated from time to time on the FEI website. When interpreting the rules, the “Notes for Guidance” document should also be taken into account and the Rules should be interpreted accordingly. Additionally, in any unforeseen or exceptional circumstances it is the duty of the Ground Jury to make a decision in a sporting spirit and approaching as nearly as possible to the intention of these Rules and of the General Regulations of the FEI.

Throughout this publication, the word “Horse” shall mean Horse and/or Pony; the masculine shall also include the feminine and the singular the plural unless otherwise stated in a specific Rule. Terms with a capitalized first letter are defined in the [FEI] Driving Rules, in the [FEI] General Regulations or in the [FEI] Statutes.

*At EC-recognized events, the word “Horse” shall also mean Horse, Pony, Very Small Equine (VSE), Donkey or Mule.*

### **Canadian Addenda**

*Wherever an addition or exception is required under these FEI rules, more specifically to address competition at Training, Preliminary, Intermediate and non-FEI sanctioned Advanced divisions, the text will appear within the article; be identified with the word **Canada** or **Canadian** in bold print; and be written in this style of italic type.*

*The word “Appendix” is used for additional information and schedules to differentiate from the word “Annex” used by the FEI in this publication.*

## CHAPTER 1 – GENERAL

### ARTICLE C900 INTERNATIONAL RULES

- 900.1 These Rules are intended to standardize International Driving Events, as far as possible, so that the conditions at such Events must be fair and similar for all Athletes.
- 900.2 A Driving or Para Driving Event commences one hour before the First Horse Inspection and concludes one half hour after the announcement of the Final Results.
- 900.3 Period of Jurisdiction — On-Site Preparation Period

The Period of jurisdiction starts 1 (one) hour before the first horse inspection until 30 (thirty) minutes after publication of the final results.

The On-Site Preparation Period is defined as the period from the opening of the stables until 1 (one) hour before the First Horse Inspection, or if the event begins before the First Horse Inspection takes place, until 1 (one) hour before the start of the first competition of the event.

During the On-Site Preparation Period, the persons responsible, owner and other support personnel are supervised by the stable manager, FEI Stewards and/or FEI Veterinarians. Any persons responsible, owner and/or support personnel who violates an FEI Rule and Regulation and/or fails to comply with instructions of the relevant FEI Official(s) during the On-Site Preparation Period is liable to be sanctioned, such sanction to be imposed by the Chief Steward, President of the Ground Jury or Technical Delegate (as applicable) when the Period of Jurisdiction has commenced.

*At EC-recognized events, the duties of supervision will be performed by competition management, Jury and Technical Delegate.*

EC recognizes this Code as set forth by the FEI

## **THE FEI CODE OF CONDUCT FOR THE WELFARE OF THE HORSE**

The FEI requires all those involved in international equestrian sport to adhere to the FEI Code of Conduct and to acknowledge and accept that at all times the welfare of the Horse must be paramount. The welfare of the Horse must never be subordinated to competitive or other interests. The following points must be particularly adhered to:

### **1. General Welfare:**

- a) Good Horse management – Stabling and feeding must be compatible with the best Horse management practices. Clean and good quality hay, feed and water must always be available.
- b) Training methods – Horses must only undergo training that matches their physical capabilities and level of maturity for their respective disciplines. They must not be subjected to methods that are abusive or cause fear.
- c) Farriery and tack – Foot care and shoeing must be of a high standard. Tack must be designed and fitted to avoid the risk of pain or injury.
- d) Transport – During transportation, Horses must be fully protected against injuries and other health risks. Vehicles must be safe, well ventilated, maintained to a high standard, disinfected regularly and driven by competent personnel. Competent handlers must always be available to manage the Horses.
- e) Transit – All journeys must be planned carefully, and Horses allowed regular rest periods with access to food and water in line with current FEI guidelines.

### **2. Fitness to compete:**

- a) Fitness and competence – Participation in Competition must be restricted to fit Horses and Athletes of proven competence. Horses must be allowed suitable rest period between training and Competitions; additional rest periods should be allowed following travelling.
- b) Health status – No Horse deemed unfit to compete may compete or continue to compete. Veterinary advice must be sought whenever there is any doubt.
- c) Doping and Medication – Any doping or illicit use of medication constitutes a serious welfare issue and will not be tolerated. After any Veterinary treatment, sufficient time must be allowed for full recovery before Competition.
- d) Surgical procedures – Any surgical procedures that threaten a competing Horse's welfare or the safety of other Horses and/or Athletes must not be allowed.
- e) Pregnant/recently foaled mares – Mares may not compete when more than four months pregnant or with foal at foot.
- f) Misuse of aids – Abuse of a Horse using natural riding aids or artificial aids (e.g. whips, spurs, etc.) will not be tolerated.

### **3. Events must not prejudice Horse welfare:**

- a) Competition areas – Horses must be trained and compete on suitable and safe surfaces. All obstacles and Competition conditions must be designed with the safety of the Horse in mind.
- b) Ground surfaces – All ground surfaces on which Horses walk, train or compete must be designed and maintained to reduce factors that could

- lead to injury.
- c) Extreme weather – Competitions must not take place in extreme weather conditions that may compromise horse welfare or safety. Provision must be made for cooling conditions and cooling equipment for Horses after competing.
  - d) Stabling at Events – Stables must be safe, hygienic, comfortable, well ventilated and of sufficient size for the type and disposition of the Horse. Washing-down areas and water must always be available.
4. **Humane treatment of Horses:**
- a) Veterinary treatment – Veterinary expertise must always be available at an Event. If a Horse is injured or exhausted during a Competition, the Athlete must stop competing and a veterinary evaluation must be performed.
  - b) Referral centres – Wherever necessary, Horses should be collected by ambulance and transported to the nearest relevant treatment centre for further assessment and therapy. Injured Horses must be given full supportive treatment before being transported.
  - c) Competition injuries – The incidence of injuries sustained in Competition must be monitored in accordance with the relevant discipline requirements. Ground surface conditions, frequency of Competitions and any other risk factors should be examined carefully to indicate ways to minimize injuries.
  - d) Euthanasia – If injuries are sufficiently severe a Horse may need to be euthanized on humane grounds by a veterinarian as soon as possible, with the sole aim of minimizing suffering.
  - e) Retirement – Horses must be treated sympathetically and humanely when they retire from Competition.
5. **Education:**
- The FEI urges all those involved in equestrian sport to attain the highest possible levels of education in areas of expertise relevant to the care and management of the Competition Horse.

This Code of Conduct for the Welfare of the Horse may be modified from time to time and the views of all are welcomed. Particular attention will be paid to new research findings. The FEI encourages further funding and support for welfare studies.

## CHAPTER 2 – STRUCTURE OF COMPETITIONS

### ARTICLE C901 CATEGORIES AND LEVELS

**901.1 Classes:** All, or any, of the following classes may be held at the same Event, but each must be classified separately:

Horse: Single (H1), Pair (H2) and Four-in-Hand (H4) Pony: Single (P1), Pair (P2) and Four-in-Hand (P4)

- 1.1 At **EC-recognized** events, tandem and/or unicorn classes for horses, ponies, and/or Very Small Equines (VSEs) may be offered under separate classification. Except for harnessing requirements that are specific to four-in-hands, unicorns will compete under the same conditions and requirements as four-in-hands; tandems will compete under the same conditions and requirements as pairs.
- 1.2 Free Style Dressage Test may be arranged by the organizing committee, provided it is not scored as part of a Combined Driving Event. See Appendix XXX for scoring
- 1.3 Prize lists and Entry forms must be approved by the Technical Delegate prior to publication and/or an event permit being issued. For events without an EC TD, approval is by the President of the Jury, if EC qualified, or by the most senior EC Judge on the jury.

**901.3 Levels of difficulty:** The levels of difficulty are defined by a progressive star rating system ranging from the lowest level (1\*) to the highest level (4\*). Senior Athletes must successfully complete FEI Competitions to progress through the Star system, as outlined in Article C913.

- 3.1 At **EC-recognized** events, the Organizing Committee of an Event may decide which Competitions are suitable for their particular Event and may include any one, two or all three competitions. Championships must consist of all three competitions.
- 3.2 At **EC-recognized** events, approval for the divisions an Organizer applies to offer shall be based upon the relative experience of the Organizer and status and relative experience of the officials hired for the event.  
Driven Dressage and Cones-only competitions may be arranged by the organizing committee under these rules.

#### 901.10 Overview of Categories and Competitions

At **EC-recognized** events:

- 10.1 A “Three-Day Event” consists of three distinct Competitions taking place on separate days. The Competitor may compete with more than one entry, schedule permitting, unless the Organizer states differently in the prize list. (See Art. CD-943.2.)
- 10.2 A “Two-Day Driving Event” may consist of either: Driven Dressage and Cones on the first day, followed by a Marathon on the second day; or Driven Dressage on the first day, followed by the Marathon and Cones on the second day.
- 10.3 A “Driving Trial” consists of three competitions: Driven Dressage first, followed by the Marathon and Cones, in either order. The Marathon is only one section (B). All three competitions may take place on the same day. The

number of entries with which a Competitor may compete is at the discretion of the organizer. See the modified competition rules in [Appendix CD-A. Driving Trials](#).

- 10.4 An “Arena Trial” may be held in a suitable indoor or outdoor arena. Refer to the modified competition rules in [Appendix CD-B. Arena Trials](#). The number of entries with which a competitor may compete is at the discretion of the organizer.
- 10.5 A “Combined Test” consists of any two competitions, but typically consists of Driven Dressage and Cones and may be offered as a stand-alone event or as part of any of the EC S- recognized events under 10.2-10.4 above.
- 10.6 A “Combined a-la-carte (CAC) event” may use any of the above formats, with class entry selections made at the competitor’s option from those published in the Prize List on the entry form. Organizers may offer one or more driven dressage tests, Marathon and Cones classes based on a combination of division and turnout. Athletes have the option to select one class for each of the three competitions. Example: Dressage – Preliminary; Marathon – Training; Cones – Intermediate.

Awards shall be limited to class entries or combined at the Organizer’s discretion. Overall division awards, if offered, are limited to entries competing in the same division for all three competitions.



## CHAPTER 3 CLASSIFICATION

### ARTICLE C902 COMPETITIONS

- 902.1 At the conclusion of each Competition, the Athletes will be classified according to the penalties received in that Competition.
- 902.2 In each Competition, the winner is the Athlete with the least number of penalties.
- 902.3 Scores will be calculated to two decimal places.

### ARTICLE C903 EVENTS

- 903.1 The Final Classification for individuals is determined by adding together the penalties received in each Competition. The Athlete with the lowest number of penalties is the winner of the Event.
- 903.2 Athletes who are Eliminated or Disqualified or who Retire or Withdraw in any one of the Competitions cannot be included in the Final Classification. They will only be listed on the result sheet as: Eliminated (E), Disqualified (D), Retired (R), or Withdrawn (W).

### ARTICLE C904 EQUALITY OF SCORES

If there is an equality of scores on completion of the three Competitions, the Athlete with the least number of penalties in Marathon will be classified above the others. If there is still an equality of points, the scores in Dressage will be the deciding factor.

### ARTICLE C908 NAMES OF HORSES

The names of the Horses must appear on all score sheets, including the name of the spare Horse.

### ARTICLE C909 – PROTESTS AND APPEALS

See Article C991

### ARTICLE C910 OFFICIAL RESULTS

Results are “official” as soon as they have been confirmed and signed by the Ground Jury and published on the official board at the Show Office. A copy of the final scores and ranking for each competition and the overall for the event must be sent to Equestrian Canada within 14 days of the event. See Article C612.

### ARTICLE C911 PRINCIPLES

#### 911.1 Penalties

The Rules concerning the Event and each Competition must be strictly enforced by the Ground Jury. Athletes who fail to comply with these Rules may incur Disqualification or Elimination, unless some other penalty is prescribed in the relevant Article.

At **EC-recognized** events, the jury member disqualifying or eliminating a competitor shall state the rule number under which the penalty is assessed.

Except for the adjustment of a rein, no horse without a bridle whose reins are attached and through the saddle terrets may be attached to a vehicle. This rule applies at all times at the driving event location.

A horse must not be left unattended while put to a vehicle. Failure to comply will incur elimination and may incur disqualification from the event.

### **911.2 Yellow Warning Card**

Where there is abuse of Horses in any form or incorrect behavior towards Event Officials or any other party connected with the Event, non-compliance with Driving Rules during the On-Site Preparation Period and Period of Jurisdiction, the President of the Ground Jury, the President of the Appeal Committee and the FEI Chief Steward, as an alternative to instituting the procedures foreseen in the legal system, may deliver to the Person Responsible a Yellow Warning Card.

### **911.3 Disqualified (D)**

Athletes and Horses may be Disqualified for contravening certain of these Rules at any time during an Event. An Athlete or Horse who has been Disqualified is prohibited from taking any further part in the Event or winning any prize. Disciplinary action may be taken subsequently by the NF of the offender or by the FEI if the incident is reported to the FEI by the Foreign Judge or Appeal Committee, or if a Yellow warning Card has been issued.

### **911.4 Eliminated (E)**

- 4.1 Athletes will be Eliminated from a Competition as a penalty for contravening certain Rules during the Competitions.
- 4.2 Athletes who are Eliminated may compete in subsequent Competition(s) in the Event.

### **911.5 Retired (R)**

Athletes, who, for any reason, do not wish to continue, may decide to Retire during any of the Competitions. If an Athlete Retires in a Competition he is allowed to compete in the subsequent Competitions in the Event.

### **911.6 Withdrawn (W)**

Athletes are deemed to have Withdrawn if, for any reason, they fail to start in any of the Competitions. Once Withdrawn, Athletes may not take any further part in the Event with the turnout in question.

### **911.7 Lamé or Unfit Horses**

If a Horse is deemed to be lame or unfit by

- The Judge at C in Dressage, the Horse must be Disqualified and may not compete in any other Competition. The Athlete is eliminated.
- A member of the Ground Jury in Marathon or Cones, the Horse will be Eliminated as well as the Athlete.

### **911.8 Placings and Prize Money**

- 8.1 Athletes who Retire or are Eliminated from any Competitions may not be placed in that Competition or in the final classification.
- 8.2 Athletes may only receive prize money in Competitions in which they have competed without Disqualification, Elimination or Retirement. No Prize Money will be awarded to an Athlete who has been disqualified from any Competition.

## **CHAPTER 4 – ELIGIBILITY (AGE OF ATHLETES – STARTING POSSIBILITIES)**

### **ARTICLE C912 MINIMUM AGE – ATHLETES AND GROOMS**

For **EC-recognized** events, the provisions of 1-4 and 6 of this article do not apply. There is no minimum age for Athletes at Training and Preliminary divisions except that Athletes under the age of 14 must be accompanied by a knowledgeable adult horseman capable of rendering assistance in an emergency at all times while driving at the event location. Junior A or B Athletes must be accompanied by a parent or parent-designated adult and a waiver acceptable to the Organizing Committee must be on file with the event Secretary. The minimum competition age for grooms is 14. Exception: Driving Trial (Training and Preliminary divisions), the minimum competition age for a groom is 12.

**912.5 Age:** Age is determined from the beginning of the calendar year in which the Athlete and grooms reach the designated age.

### **ARTICLE C913 MINIMUM ELIGIBILITY REQUIREMENTS / QUALIFICATION CRITERIA**

#### **913.3 Eligibility for EC-recognized Events**

##### **3.1 Training division**

- a.** Open to a horse that has not completed\* more than one recognized Combined Driving Event (CDE) or Driving Trial (DT) above the Training division, driven by a driver of any level of competitive experience, or
- b.** Open to a driver who has not completed\* more than one recognized CDE or DT above the Training division, with a horse of any level of competitive experience.
- c.** Limit classes are open only to horse and driver combinations not yet eligible for Preliminary Division.

##### **3.2 Preliminary division**

- a.** The driver has completed\* at least two recognized CDEs or two DTs or had other equivalent driving experience.

##### **3.3 Limit classes are open to drivers who are not yet eligible for Intermediate division competitions.**

##### **3.4 Intermediate division – the driver has completed\* at least three Preliminary division CDEs.**

##### **3.5 Hybrid divisions (Intermediate II) offering Advanced Dressage and Cones – the driver has completed\* at least four Preliminary or Intermediate division CDEs.**

\* Note: Completed means the entry is classified in each event including marathons without being disqualified, eliminated, retired or withdrawing from any of the competitions.

### **ARTICLE C915 HORS CONCOURS**

No Athlete may take part “Hors Concours” in any International Competition.

At **EC-recognized** events, a Competitor may enter as HC at the discretion of the organizer subject to scheduling limitations. An HC, when driven as a second entry, must be driven after the competing entry.

## **CHAPTER 5 – ATHLETES**

## ARTICLE C928 DRESS, SAFETY AND WHIPS

All persons must wear securely fastened, approved\* protective headgear whenever riding a horse or aboard a carriage at the event location (\* see Glossary, Section A – Headgear Standards). The responsibility for compliance rests with each person on the vehicle. Failure to comply results in elimination of the entry, and the competitor will not be allowed to continue in the event.

Medical armbands are strongly recommended for all persons whenever riding a horse or aboard a carriage at the event location.

### 928.1 Dress in Dressage and Cones on a Dressage Carriage

- 1.1 The dress of Athletes and Grooms must conform to the style of the Carriage and harness used. Jackets or national dress, driving aprons, hats and gloves are obligatory for Athletes. At **EC-recognized** events, jackets are optional for lady drivers.
- 1.2 Jackets or national dress, driving aprons, and gloves are obligatory for Athletes. Para Driving Athletes from nominated profiles may compete with no gloves or adapted gloves but must have this noted on the Masterlist following classification evaluation.
- 1.3 Grooms must wear jackets or national dress, hats and gloves.
- 1.4 In Cones, Grooms must remain seated in their proper positions between the start line and the finish line.
- 1.5 The President of the Ground Jury may decide that:
  - Jackets may be removed in excessively hot and humid weather.
  - Cooling vests may be worn in excessively warm weather except at times when body protectors are mandatory.
  - Wet weather clothing may be worn and aprons not required in wet weather.
- 1.6 Penalties for improper dress are stated under Articles C957 and C981.

### 928.2 Dress in Marathon and Combined Marathon

- 2.1 Less formal dress is acceptable in Marathon for the Athlete and Grooms. Shorts are not permitted. Infringement will incur 10 penalties per person.
  - At **EC-recognized** events, non-permitted "shorts" are defined as clothing that does not cover the legs to the ankles.
- 2.2 During the marathon, or any competition that includes marathon-type obstacles, Athletes and Grooms must wear securely fastened Protective Headgear and a back protector that is in compliance with the applicable international testing standards. Infringement will result in Elimination.
- 2.3 In addition, failure to wear such Protective Headgear and back protectors where and when required after being notified to do so by an Official, shall result in a Yellow Warning Card being issued to the Athlete.
- 2.4 When a body/back protector is required, air protector can be used combined with a real back or body protector but never without.

At **EC-recognized** events:

- 2.5 Medical Armbands are strongly recommended.
- 2.6 All persons on the vehicle during Marathon must wear properly fastened protective headgear which meets or exceeds international testing standards including ASTM (American Society for Testing and Materials)/SEI (Safety Equipment Institute) standards for equestrian use and carries the SEI tag. It

must be properly fitted with harness secured and securely fastened by a permanently affixed safety harness. The responsibility for compliance rests with each person on the vehicle. Failure to comply results in elimination of the entry, and the competitor will not be allowed to continue in the Marathon.

### **928.3 Dress for Athletes and Grooms under the age of 18**

- 3.1 At all times, while on a carriage, Athletes and Grooms under the age of 18 must wear a body/back protector and a securely fastened Protective Headgear. Infringement will result in Elimination.
- 3.2 In addition, failure to wear such Protective Headgear and back protector (in compliance with the applicable international testing standards) where and when required after being notified to do so by an Official, shall result in a Yellow Warning Card being issued to the Athlete.
- 3.3 During Horse inspections, it is strongly recommended for Athletes and Grooms under the age of 18 to wear securely fastened Protective Headgear.

### **928.4 Whip for Dressage and Cones**

- 4.1 The Athlete must carry a driving whip.
- 4.2 An Athlete must start the competition with a whip in hand or incur 5 penalty points.
- 4.3 If an Athlete drops or puts down his whip, when in the arena, or if it is not held in the hand, he will incur 5 penalty points.
- 4.4 The whip, if dropped, need not be replaced and the Athlete may finish without a whip. However the Groom may hand the Athlete a spare whip and without any further penalty.
- 4.5 Para Driving Athletes from nominated profiles may compete with the whip held/used by groom, but must have this noted on the Masterlist following classification evaluation. Refer to Para-driving rules.

### **928.5 Whip for Marathon and Combined Marathon**

- 5.1 The whip can only be used by the Athlete. Failure to comply will incur 20 penalties.
- 5.2 Para Driving Athlete from nominated profiles may compete with the whip held/used by groom, but must have this noted on the Masterlist following classification evaluation. See Para Driving rules.

## **CHAPTER 6 – HORSES**

### **ARTICLE C929 AGE OF HORSES**

In CAI 1\*, Horses must be 5 years old or over. In CAI 2\* and above, Horses must be 6 years old or over. Failure to comply with this Article will result in the Disqualification of the Horse.

At **EC-recognized** events, horses/ponies must be a minimum of four years of age to enter any Competition.

### **ARTICLE C930 HEIGHT**

930.1 For Driving Ponies maximum height and measuring, please refer to the FEI Veterinary Regulations CHAPTER IX - PONY MEASURING.

930.4 At **EC-recognized** events, the Organizer may have one class for all ponies, or divide pony classes in up to 3 sub-classes based on size as follows:

<b>LARGE PONY</b>	<b>SMALL PONY</b>	<b>VERY SMALL EQUINE</b>
-------------------	-------------------	--------------------------

120-148 cm . with or without shoes or 149 cm . with shoes	99 cm .- less than 120 cm . with or without shoes	Under 99 cm .l
1) At EC-recognized events, VSEs and ponies 99 cm . and above may compete in all divisions at speeds not greater than published in Art. C960.2.9 and Appendix CD-E.		

At **EC-recognized** events, in a mixed-height turnout, the speeds for the larger animal will apply. Horse/pony combinations are allowed.

## **ARTICLE C931 NUMBER OF HORSES**

- 931.1 The correct number of Horses stipulated for each class must be driven throughout each Competition. Athletes may not remove one or more Horses during a Competition and continue with less than the number stipulated for their Class.
- 931.2 A Horse may only take part once in each Competition.
- 931.3 Failure to comply any part of this Article will result in elimination.

## **ARTICLE C932 SPECIAL CONDITIONS**

Mares are not allowed to compete after their fourth month of pregnancy or with a foal at foot. If it is subsequently confirmed that a mare competed under either of these conditions, she will be Disqualified from all Events to which these conditions applied and the case will be reported to the [FEI] Secretary General (See Code of Conduct).

## **ARTICLE C933 WELFARE OF THE HORSE (ABUSE OF HORSES AND DOPING)**

### **933.1 Abuse of the Horse – Definition**

Abuse of Horse means an action or omission that causes or is likely to cause pain or unnecessary discomfort to a Horse including, but not limited to:

- a. Pressing of exhausted Horses,
- b. Excessive use of a whip,
- c. An unacceptably severe, badly fitting, broken or damaged bit;
- d. Badly fitting harness which might cause distress to the Horse,
- e. Damage to a Carriage which might cause injury to the Horse.

### **933.2 Wounds and Lacerations**

- 2.1 Blood on Horses may be an indication of abuse of Horse and must be investigated case by case by any member of the Ground Jury.
- 2.2 Such horses may be eliminated from the Competition. In extreme cases where abuse is evident, further sanctions will be taken against the Athlete, such as a Yellow Warning Card.
- 2.3 In minor cases of blood in the mouth, such as where a Horse appears to have bitten its tongue or lip, or minor bleeding on limbs, after investigation the Athlete may be authorized to continue.

### **933.3 Reporting**

Stewards, or any other Official, must report any instance of abuse of the Horse to any member of the Ground Jury as soon as possible.

At **EC-recognized** events, the President of the Jury may assign the above responsibilities to other qualified individuals.

### **933.4 Penalty**

Acts deemed as Abuse of Horse will result in the imposition by the Ground Jury of any or a combination of the following penalties:

- a. Yellow Warning card
- b. Fine
- c. Elimination
- d. Disqualification from the Event.

## **ARTICLE C934 STABLE SECURITY**

At **EC-recognized** events, stable arrangements and security are at the discretion of the Organizer and approval of the Technical Delegate. Arrangements must be published with the Prize List.

### **934.2 CAIs**

- 2.1 See [FEI] Veterinary Regulations, Article 1008.
- 2.2 Stable security as described in the Veterinary Regulations is not required. The OC is responsible for the control of all stable areas so that the following minimum security requirements are met:
  - The Welfare of the Horse is the first priority.
  - 24-hour security and supervision of the Stable Area(s) must be maintained whenever any stables are occupied.
  - Security fences are not obligatory, but fences and gates may be installed for safety and security reasons at the discretion the OC.
  - The stabling area must be approved by the Technical Delegate in conjunction with the FEI Chief Steward.
  - No Horse may be stabled overnight inside a truck or trailer. Only the Technical Delegate in consultation with the Chief Steward and the FEI Veterinary Delegate may grant exceptions in extreme circumstances or wet ground conditions in the stable area.

## **ARTICLE C935 EXAMINATIONS AND INSPECTIONS OF HORSES**

See [FEI] Veterinary Regulations,

### **935.1 Examination on Arrival.**

At **EC-recognized** events, the Examination on Arrival is not required.

- 1.1 This must take place at all Events upon arrival of competing Horses, and in any case before they enter the Event stables.
- 1.2 The purpose of this Examination on Arrival is to establish the Horses' identity by checking the passport and any other relevant documents, and to establish its general state of health.
- 1.3 The Examination on Arrival must be performed by the Veterinary Delegate or a Treating Veterinarian of the host country.
- 1.4 Any doubtful cases concerning identity or health must be reported to the Veterinary Delegate (if he does not perform the Examination himself) or to the Veterinary Commission as soon as possible and in any case not later than one hour before the First Horse Inspection.

### **935.2 First Horse Inspection**

*At **EC-recognized** events, the First Horse Inspection is at the option of the Organizer. When required, it must be stated in the prize list.*

- 2.1 This must take place at all Events before the start of the first Competition. It must be performed under the direction of the President of the Ground Jury, together with at least one other member of the Ground Jury, the Veterinary Delegate and/or the President of the Veterinary Commission. See [FEI] Veterinary Regulations and Guidelines for OCs and Officials for details.
- 2.2 For safety reasons, Horses must be presented in bridles and shown on a

- loose rein or lead. Each Horse must display its identity number (944.2).
- 2.3 Horses are not permitted to wear bandages or blankets/rugs.
  - 2.4 No Horse may be presented with its identity concealed in any manner by application of paint or dye for example.
  - 2.5 One FEI Driving Steward carrying a whip must be present. He is the only person who may assist if a horse refuses to trot. Handlers may not carry a whip while presenting the Horse. The use of a short whip for restraint of stallions and difficult Horses may be permitted by the Inspection Panel upon request. (See [FEI] Veterinary Regulations, Article 1043).
  - 2.6 At **EC-recognized** events, where a First Inspection is required, the President of the Jury will assign this responsibility to another qualified individual. The Inspection consists of an initial observation of the Horse standing still. It must then be walked in front of the Inspecting Committee, then trotted 30 metres away from the Committee before returning toward the Committee at the trot.
  - 2.7 A Veterinarian may be allowed to handle a limb or other parts of the body, but he may not perform any other clinical tests (i.e., flex a limb, or walk or trot a Horse in a circle.) See [FEI] Veterinary Regulations, Article 1038.
  - 2.8 In exceptional or doubtful cases, the Inspecting Committee may direct that a Horse be placed in an officially supervised holding area (no whips allowed) for a further inspection to take place at a convenient time, during the Inspection or in addition to be re-inspected on the following day without any request or presumption by the Athletes.
  - 2.9 A re-inspection on the following day is only possible if no decision (accepted or not accepted) is made on the day of the Horse Inspection. The Horse must be presented by the same person as before. In all cases of further inspection or re-inspection, the opinion of the VD must be made clear to the panel. Each Member of the Ground Jury and the Veterinary Delegate will be issued with a voting slip on which they must check either a Yes or No box to indicate whether they consider the Horse fit to compete. After consideration of the veterinary opinion from both Veterinary Delegates and holding box Veterinarian, these forms will be handed to the President of Jury who will announce the majority decision as to whether the Horse may compete. When there are two lanes of Horses of a same class being inspected the Ground Jury of both lanes will come together along with the Veterinary Delegate from each lane.  
If there is an even number of Ground Jury members and Veterinary Delegates, then the Veterinary Delegate's vote from that particular lane will be counted twice. There is no Appeal against this decision. It is compulsory to have a Veterinarian available in the holding box.
  - 2.10 Any horse which is due for re-inspection on the following day and is accepted, can be sampled for Prohibited Substances.
  - 2.11 Only a member of the Ground Jury has the authority to disqualify any horse which is considered to be unfit for the Event (marked lameness, serious injury or poor general condition). A Veterinarian has no authority to disqualify a horse except where there is a welfare issue.
  - 2.12 The Athlete or his representative who presents the Horse must be smartly dressed.

### 935.3 In-Harness Horse Inspection

- 3.1 This must take place at all Events during, and at the site of, the 10-minute Compulsory Rest prior to Section B of Marathon. One Veterinarian is



responsible for this Inspection. It must be performed carefully but rapidly so that the Athlete has time to care for his Horses before the start of Section B. When the Section A is a controlled Warm-Up, the compulsory rest may be shortened to 5 minutes before the Start of B.

- 3.2 The fitness of the Horses must be determined by clinical observation, which may include: measuring the heart rate, the respiratory rate and the temperature in accordance with the Veterinary Regulations. These observations must be recorded.
- 3.3 The Ground Jury member must eliminate the Athlete if his horse is considered to be lame, injured or obviously exhausted and unfit to continue the competition.

#### **935.4 In-Harness Examination**

The Second Examination must take place at the finish of Section B of Marathon at all Events. It must be performed under the supervision of a Treating Veterinarian in case any horse needs immediate treatment. The Veterinarian has no authority to disqualify a horse. He must report his findings to the Veterinary Delegate and the President of the Jury as soon as possible after the last Athlete has completed the Marathon.

#### **935.5 In-Harness Inspection before Cones**

- 5.1 The In-Harness Inspection must be carried out before the turnout starts the Cones test, only when Cones follow Marathon. It must be performed by an Inspecting Committee consisting of one member of the Ground Jury together with the Veterinary Delegate, or the Veterinary Commission. The Inspection is obligatory at all Events when Cones follow Marathon. The Horse(s) must be presented by the Athlete himself. Competing without presenting will result in an Elimination.
- 5.2 Horses will be inspected harnessed to their carriages. Leg bandages, overreach boots and brushing boots are permitted, but must be removed if required.
- 5.3 Only the Ground Jury member has the authority to Disqualify the Horse if it is considered to be unfit to continue the event. (It is permitted to substitute a Horse who has failed the In-Harness Inspection before Cones, upon re-presentation, the Athlete may start the Cones Competition and therefore change the declaration.)

#### **935.6 Removing a Horse from Competition**

- 6.1 Each member of the Ground Jury has the right and duty to eliminate any horse at any time, which is evidently lame, injured or unfit to continue. No appeal may be made against a decision taken under the terms of this article.
- 6.2 The Athlete may Retire at any time.

#### **935.7 Medication Control of Horses**

- 7.1 This must be conducted in accordance with [FEI] General Regulations and the [FEI] Veterinary Regulations.  
At **EC-recognized** events, the use, control and testing of medication and other foreign substances shall be in accordance with EC Rules and Regulations.
- 7.2 At **EC-recognized** events, the purpose of all Competitions is to match the talents of horses and Competitors against each other under fair and equal conditions. To ensure that the normal performance of a horse during a competition is not affected either deliberately or unintentionally by the influence of drugs, medications, or any form of veterinary treatment, the use of any prohibited drugs or medications is not allowed.

935.8 AT EC-RECOGNIZED EVENTS, THE PROVISIONS OF THIS PARAGRAPH DO NOT APPLY.

## CHAPTER 7 – CARRIAGES AND HARNESS

### [FEI] Permitted Carriages

CATEGORY	DRESSAGE	MARATHON	CONES	COMBINED MARATHON/ CONES
Championships	Dressage Carriage or Marathon Carriage <sup>1</sup>	Marathon Carriage	Dressage Carriage or Marathon Carriage <sup>1</sup>	N/A
CAIO 4*	Dressage Carriage or Marathon Carriage <sup>1</sup>	Marathon Carriage	Dressage Carriage or Marathon Carriage <sup>1</sup>	N/A
CAI 3*	Dressage Carriage or Marathon Carriage <sup>1</sup>	Marathon Carriage	Dressage Carriage or Marathon Carriage <sup>1</sup>	N/A
CAI 2*	Dressage or Marathon Carriage <sup>1</sup>	Marathon Carriage	Dressage or Marathon carriage <sup>1</sup>	Marathon carriage
CAI 1*	Dressage or Marathon carriage (solid rubber or pneumatic tires)	N/A	Dressage or Marathon carriage <sup>1</sup> (solid rubber or pneumatic tires)	Marathon carriage (solid rubber or pneumatic tires)
CAII* Indoor	N/A	N/A	N/A	Marathon carriage (solid rubber or pneumatic tires)

1) Carriage with correct Dressage width as specified under [Art. C-937.3](#)

## ARTICLE C937 WEIGHTS AND DIMENSIONS

### 937.1 General

- 1.1 In all classes, during Dressage, Marathon, Cones and Combined Marathon, if the carriage has no brakes, breeching is compulsory. Failure to comply will result in Elimination. In Single Horse and Single Pony classes breeching is compulsory  
*At EC-recognized events, including Driving Trials, Athletes may use a two- or four-wheeled vehicle for single horse/pony/VSE classes. For classes offering Advanced Dressage tests and Cones specifications (Intermediate II), a groom is required for single horse and pony drivers. A groom is optional for single horse and pony drivers in dressage and Cones Competitions only as well as in Marathon for all single equine turnouts less than 120 cm. Exception: See [Art. CD-973.1](#) and [Art. CD-974.1](#) for events where the Organizer has opted to use standardized Cone settings and has published the specifications in the prize list.*  
*At EC-recognized events, there are no required carriage weights or track widths. (See [Appendix CD-E. Quick Reference Guide for CDEs](#)).*
- 1.2 No part of a carriage may be wider than the outside Track Width, with the exception of hub caps, mud guards and the Splinter Bar for carriages used in Dressage and Cones.
- 1.3 The track width of all carriages is measured at ground level on the widest part of the rear wheels.
- 1.4 Athletes whose carriages do not conform to the required weights or measurements will be eliminated from the relevant Competition.

**937.2 Carriages for Para-Driving:**

- 2.1 Carriages suitable for the Para-Athlete must be used and carriages for Para-Driving Singles may be 2 or 4-wheeled.
- 2.2 The OC or Technical Delegate may refuse the use of a carriage, but must give reason for the refusal.

**937.3 [FEI] Dressage Carriages must comply with the following:**

CLASS	WHEELS	GROOMS	MIN WIDTH
Horse Four-in-hand	4	2 behind	158 cm
Pony Four-in-hand			138 cm
Horse Pair	4	1 behind	148 cm
Pony Pair			138 cm
Horse Single	2 or 4	1 behind or beside	138 cm
Pony Single			

*At EC-recognized Dressage and Cones competitions, the following table applies for Training, Preliminary, Intermediate, and all Advanced division classes for VSEs and Small Ponies.*

CLASS		GROOMS	WHEELS	WT / WIDTH
FOUR-IN-HAND OR UNICORN	Horse, Pony	2 behind	4	No minimum weight or width
	Small Pony, VSE	1 behind		
PAIR	Horse, Pony, Small Pony, VSE			
TANDEM	Horse, Pony, Small Pony, VSE	1 behind or beside	2 or 4	
SINGLE	Horse, Pony, Small Pony, VSE	Athlete Option or Organizer Required		

- a. *At EC-recognized events, see Art. C-937.1.1 and Art. C-943.2.14 for all single equine turnouts.*
- b. *At EC-recognized events, there are no required track widths. (See Appendix CD-E. Quick Reference Guide for CDEs). Exceptions:*
  - (1) *Entries in classes offering Advanced Dressage tests and Cones specifications (except for VSE and Small pony turnouts) must follow all vehicle requirements under FEI CAI 2\* rules.*
  - (2) *See Art. C-973.1 and Art. C-974.1 for events where the Organizer has opted to use standard Cones settings and has published the specifications in the prize list.*
- 3.1 The same Carriage must be used for Dressage and Cones for CAI2\* and above.  
*The same carriage must be used for Dressage and Cones for all EC Combined Driving Competitions.*
- 3.2 Artificial extensions to increase the measured width of a Carriage are not permitted in Cones.
- 3.3 All carriages must be measured as soon as the Athlete has left the competition arena. *At EC-recognized events, measuring after the competition is not required.*

**937.4 [FEI] Marathon Carriages must comply with the following:**

CLASS	WHEELS	MIN WEIGHT	GROOMS	MIN WIDTH
Horse Four-in-hand Pony Four-in-hand	4	600 kg 300 kg	2 behind	125cm
Horse Pair Pony Pair	4	350 kg 225 kg	1 behind	
Horse Single Pony Single	4	150 kg 90 kg	1 behind	

4.1 In Marathon, all Carriages will be measured before the start of section B and the same Carriage must be used for all sections.

*Carriage measurement is optional at EC-recognized events.*

4.2 The President of the Ground Jury will decide whether all, or a random selection, of Carriages will be weighed after Marathon.

At **EC-recognized** competitions, the following table shall apply for Marathon:

CLASS		GROOMS	WHEELS	WT / WIDTH
FOUR-IN-HAND OR UNICORN	Horse, Pony	2 behind	4	No minimum weight or width
	Small Pony, VSE	1 behind		
PAIR	Horse, Pony, Small Pony, VSE			
TANDEM	Horse, Pony, Small Pony, VSE	1 behind or beside	2 or 4	
SINGLE	Horse, Pony	None required		
	Small Pony, VSE			

At **EC-recognized** events, see [Art. C-937.1.1](#) for all single equine turnouts.

At **EC-recognized** events, drivers may use a two- or four-wheeled vehicle for single horse/ pony/Small Pony/VSE classes.

## ARTICLE C938 EQUIPMENT

Dressage Carriages may be fitted with forward facing lamps and rear lamps or reflectors in Dressage only. Lamps or reflectors are not compulsory in Cones.

- At **EC-recognized** events, Athletes competing in hybrid divisions offering Advanced. Dressage and Cones must follow all FEI rules pertaining to Athlete and Groom participation. In Training, Preliminary and Intermediate division classes and for Advanced VSE or small pony turnouts, lamps are not required.
- At **EC-recognized** events, easily visible red reflectors must be fitted on all vehicles unless the vehicle is fitted with a rear lamp. In addition to reflectors, Slow Moving Vehicle (SMV) signs may be required by local municipal regulations. The Organizer may waive the requirement for reflectors at divisions other than Advanced provided: (1) no public roads are used; (2) no local by-laws would be violated; and (3) notice is published in the Prize List.
- In all **EC-recognized** competitions, Athletes may carry whatever spares they require. For Training and Preliminary division classes, the following spares shall be carried on the vehicle throughout the event:
  - Spare trace or trace splice

- b) Spare rein or rein splice
- c) Leather punch
- d) Halter and lead shank for each horse
- e) For full collar harness: spare hames strap
- f) For pairs: spare whippletree.
- g) For teams: spare lead bar.

Penalty for any required item above not carried shall be 2 penalty points, to a maximum of 10 penalty points. Spares shall be checked during Presentation at the halt and prior to starting Marathon. Spares may also be checked at compulsory rest stops and at the end of the Marathon.

- 4. It is strongly recommended that the following additional items be carried on the vehicle at all times:
  - a) Wheel wrench to fit axle nut
  - b) Pliers
  - c) Hoofpick
  - d) Screwdriver
  - e) Whistle or other means to signal for help.
  - f) Length of rawhide, string or wire
  - g) Small hammer
  - h) Knife suitable to cut harness
  - i) First Aid kit
- 5. Athletes shall not be penalized for or for not carrying additional items

## **ARTICLE C939 TIRES**

Tires – At EC-sanctioned competitions, pneumatic tires may be used in Training, Preliminary and Intermediate provided that the wheel on which they are mounted is engineered for use on a carriage. Tire tread is optional. The use of wire spoke wheels is limited to use in the Training division at the discretion of the-Organizing Committee and approved as safe by the event TD and ground jury.

## **ARTICLE C940 HARNESS, CARRIAGE AND HORSES**

### **940.1 Harness**

- 1.1 The distance between Horse/Pony and carriage must be not less than 50cm at all times, fender rolls, 40cm.
- 1.2 Dressage Carriage:
  - 1.2.1 Horses (Four-in-Hand wheelers or a Pair of Horses): the distance between traces must be minimum 55 cm (Ponies: minimum 45 cm).
  - 1.2.2 Traces must not cross each other. Swingle trees may not cross the center line of the carriage.
- 1.3 Marathon Carriage:
  - 1.3.1 Horses (Four-in-Hand wheelers or a Pair of Horses): the distance between the traces must be minimum 55 cm (Ponies: minimum 45 cm.).
  - 1.3.2 Traces must not cross each other.

In addition:

- 1.4 Length of individual pole chains or pole straps: the length has to be minimum 30 cm. The measurement is taken from the center of the pole head, including the complete quick release. For Small Ponies and VSEs, the measurement may be reduced to 20 cm.
- 1.5 Horse yoke or T-bar: the total width including the complete quick releases has to be minimum 60 cm. For Small Ponies and VSEs, the measurement may be reduced to 40 cm. When the measurement is taken from the center

of the pole head, to include the complete quick releases, it has to be minimum 30 cm. for Horses and Ponies, and may be 20 cm for Small Ponies and VSEs.

- 1.6 Yokes or T-bars must not be positioned behind any part of the shoulder.
- 1.7 Pole and the pole straps must be of sufficient length to allow free movement of the Horses.
- 1.8 For Horse Four-in-Hand leaders, the complete lead bar must measure at least 1m and the distance between the traces must measure at least 45 cm.
- 1.9 For Pony Four-in-hand leaders, the complete lead bars must measure at least 85cm and the distance between the traces must measure at least 35 cm.
- 1.10 Yoke width or pole straps must be sufficient to allow the free movement of the Ponies.
- 1.11 It is not necessary to use the same harness for Dressage and Cones, but in both Competitions, it must be safe, clean and uniform in appearance and in a style appropriate to the turnout.
- 1.12 The Horses must be correctly and fully harnessed to the carriage, including the reins.
- 1.13 Failure to comply with their rules will result in a verbal warning or Yellow Warning Card, given by the Ground Jury. Subsequent offenses at the same event will be penalized a second yellow Warning Card or Elimination.
- 1.14 During the On-Site Preparation Period and the Period of Jurisdiction whenever a single Horse/Pony is harnessed to a carriage, breeching is compulsory. Failure to comply results in Elimination.
- 1.15 Where forbidden equipment is used or severe incidence on the welfare of the Horse is ascertained, the penalty will be Elimination or Disqualification (see Article C937.1).

#### **940.2 Bandages and Brushing Boots**

- 2.1 Bandages and Brushing Boots are not permitted in Dressage. Failure to comply will result in 10 penalty points.  
*At EC-recognized events, this also applies to overreach boots. Hoof boots that cover the sole of the hoof are permitted.*
- 2.2 *If a penalty is applied under Art. C-940.2.1 above, the Bandages or Brushing Boots must be removed immediately after leaving the Arena and the Horse(s) inspected by a Veterinarian or an FEI Steward who will report his findings to the President of the Ground Jury.*  
*At EC-recognized competitions the above inspection may be performed by the Ground Jury if a Veterinarian is not in attendance.*

#### **940.3 Nosebands, ancillary equipment and blinkers**

- 3.1 Any nosebands, attachments or ancillary equipment which impede or are likely to impede the free intake of air into the nostrils of the Horse are not permitted. *See Art. 17.2.*
- 3.2 Blinkers, if used, and ancillary equipment must not impede forward vision or be so close to the eyes as to irritate them.
- 3.3 Only one sort of bit lifter per Horse/Pony may be used at one time.

#### **940.4 Connecting straps**

Connecting straps between neck or breast collars may be used in all Four-in-Hand Competitions. The leaders may not be attached to each other in any other way (except by the Reins).

#### **940.5 Auxiliary reins**

- 5.1 Auxiliary reins (including any type of check reins) are not permitted when in harness.

*At EC-recognized events for Training division only, side checks may be used at the Driver's discretion.*

- 5.2 [FEI] Para-Driving: driving with a second set of reins or divided reins is not allowed.

*At EC-recognized events, Para Athletes in Training division only may use a second set or divided reins at their discretion.*

#### **940.6 Tails**

Tails may not be tied or attached to any part of the harness or Carriage, with the exception of a recognized tail guard. No other ancillary device restricting the free movement of the Horse's tail is permitted.

#### **940.7 Leverage Devices**

All rings, terrets and/or other devices which have an extreme leverage effect on the reins or bits are forbidden at any time within Showgrounds.

#### **940.8 Bits**

- 8.1 Bits do not need to be identical
- 8.2 No bitless bridles and hackamores (even combined with any kind of bit) are permitted when the Horse is harnessed to a carriage.
- 8.3 Bits cannot be connected to reins by clips or snaps.

#### **940.9 Tongues**

Tongue guards are only permitted if used correctly; separate items must not be incorporated around the bit so as to cause welfare concerns. (See FEI Veterinary Regulations Article 1046.5).

#### **940.10 Impaired Vision**

No attachment or ancillary harness may be positioned between the wheelers and the leaders in such a way as to impair the vision of either of the wheelers.

#### **940.11 Application or use of devices, substances or implements**

- 11.1 An attachment to the pole, traces or shafts, application or use of any substance, device, or implement which may cause irritation or discomfort to the horse is forbidden within the Showgrounds.
- 11.2 Ear hoods and plugs are permitted. Ear hoods may not be attached to the noseband and must allow free movement of the ears of the Horse. Failure to comply will result in 5 penalty points.

#### **940.12 Shoes**

Any conventional type of shoe is permitted; double shoes or additional weight (lead) are not allowed.

*At EC-recognized events, boots protecting the sole of the foot are allowed in Marathon.*

#### **940.13 Penalties**

- 13.1 Contravention of any paragraph in this Article in Competition will incur Elimination of the Athlete, exception for [Art. C-940.1.1](#) to [Art. C-940.1.13](#) and [Art. C-940.11.2](#).
- 13.2 For contravention at any other time within the Showgrounds, with the exception of [Art. 940.1](#), will result in a Yellow Warning Card. A second offence at the same event will result in a higher penalty, up to and including disqualification at the discretion of the Ground Jury.

## ARTICLE C941 ADVERTISING ON CARRIAGES, HARNESS AND CLOTHING

### 941.1 In Dressage and Cones

- 1.1 The name of the harness manufacturer may appear once on each harness on a label no wider than the strap on which it appears and not longer than 10 cm.
- 1.2 The sponsor's name or "logo," or the Athlete's "association," may appear on each side of the carriage within a surface area no greater than 400 sq. cm.
- 1.3 The name of the carriage manufacturer may appear on a Carriage on a label of not more than 50 sq. cm. Identification of clothing manufacturers may appear only once per item on a surface area not exceeding 3 sq. cm.
- 1.4 While present in the Competition arena, the name and/or logo of the individual's sponsor(s) and team sponsor(s) may appear on the surface area not exceeding 80 sq. cm and only once on jackets or top garments at the height of the breast pockets of Athletes.
- 1.5 The name and/or logo of the individual's sponsor(s) and team sponsor(s) may appear on a surface area not exceeding 16 sq. cm on both sides of the Athlete's shirt collar.

### 941.2 Advertising in Marathon

Advertising is allowed on carriages and all clothing. The name of the harness manufacturer may appear once on each harness on a label no wider than the strap on which it appears and no longer than 10 cms.

### 941.3 Penalties

Contravening any of the rules on advertising will result in a Yellow Warning Card issued by the President of the Ground Jury or the Chief Steward.

## ARTICLE C942 SAFETY

- 942.1 In the Show grounds, whenever the Horse(s) are fully harnessed or being harnessed to a carriage, Groom(s) must at all times be in attendance and able to render assistance if needed. Whenever horses are driven, a groom must be on the carriage or if there is no seat available, at hand on the training field.  
*At EC-recognized events, see Art. C-943.2.14 for exemptions for single turnouts.*
- 942.2 The Athlete may only dismount from the carriage when Grooms are at the Horses' heads, or the reins are given to another responsible person on the carriage.
- 942.3 No Horse may be led from a moving carriage.
- 942.4 During the On Site Preparation Period and the Period of Jurisdiction, no person under the age of 14 may be on a carriage (except for Children Classes - see article 912)
- 942.5 Contravening the safety rules will result in a Yellow Warning Card being issued by the Ground Jury or the Chief Steward. Subsequent offenses at the same event will be penalized by a second Yellow Warning Card or penalty up to Elimination at the discretion of the Ground Jury
- 942.6 *At At EC-recognized events, failure to comply with the following may incur elimination or disqualification:*
  - a. *Whenever fully harnessed to a vehicle and while being harnessed to a vehicle, a horse must wear a bridle with reins attached to the bit and passed through the saddle terrets. Exception:*
    - (i) *Once a horse is fully harnessed to a vehicle, one rein at a time*



- may be adjusted.
- (ii) Horses in pair or multiple hitches must have at least one rein attached to the bridle while being harnessed to a vehicle.
  - b. The horse must never be left unattended while put to a vehicle.
  - c. In case of infringement on these rules, a warning must be given by the Ground Jury to first-time offenders and reported by the TD on their report form.

**942.7** At **EC-recognized** events, each entry shall complete the Safety Checklist prior to competing. A completed copy of the Safety Checklist as illustrated in Appendix CD-D must be presented at the safety check in harness immediately before the start of any Marathon Competition.

**942.8** At **EC-recognized** events, in case of infringement on these rules, a warning must be given by the Ground Jury to first-time offenders and reported by the EC TD in ~~his~~ their report form and may result in a Yellow Warning Card being issued.

## CHAPTER 8 – CONDITIONS FOR PARTICIPATION

### ARTICLE C943 PARTICIPATION

#### 943.1 Method of Driving

- 2.1 Athletes may use any method or style of driving.
- 2.2 Para Driving Athletes from nominated profiles may compete with the whip held/ used by groom, the brake operated by the groom, and the groom holding the finger loop, but must have this noted on the Masterlist following classification evaluation. *At EC Competitions, the Para Athlete will be required to have the applicable dispensation. See Dispensation form Appendix 7D.*

#### 943.2 The Athletes and Grooms participation:

*At EC-recognized events, Drivers or Grooms may participate in any Competition more than once at any Event, subject to scheduling requirements, unless otherwise stated in the prize lists.*

ATHLETES	AT ONE SAME EVENT			
	permitted number of starts	allowed to compete in different category as Athlete	Act as groom in same category	Act as groom in different category
CAIO, Championships	1	no	no	no
CAI3* WC Qual	up to 2	yes	no	no
Championships for YH	multiple	yes	no	no
CAI3* (not WCQual)	up to 2	yes	no	no
CAI2*	up to 2	yes	yes in CAI1* or CAI2*	yes in CAI1* or CAI2*
CAI1*	up to 2	yes	yes in CAI1* or CAI2*	yes in CAI1* or CAI2*

GROOMS	AT ONE SAME EVENT		
	permitted number of starts	allowed to compete in different category as Groom	allowed to compete in different category as Athlete
CAIO, Championships	multiple (except on Marathon only once)	yes (except on Marathon)	No
CAI3* WC Qual	Multiple	yes	no
Championships for YH	multiple	yes in each category: 5-6-7 year	no
CAI3* (not WC Qual)	multiple	yes	no
CAI2*	multiple	yes	yes in CAI1* or CAI2*
CAI1*	multiple	yes	yes in CAI1* or CAI2*

- 2.1 Each Athlete must drive the same Horse(s) in all the Competitions, except where a substitution was decided in compliance with the rules. See -C946.2.2-2.4 Omitted (reserve)
- 2.5 The penalty for contravening [-C943.2.1-2.4](#) will be the elimination of the Athlete(s) concerned by any of the offences.
- 2.6 The Athlete is the only person allowed to handle the reins, use whip and brake throughout each Competition. Each contravention of this rule, even if to prevent an accident, will result in 20 penalties. However, a Groom may handle the reins and brakes without penalty in all Competitions provided the carriage remains stationary.
- 2.7 No person may be tied to the Carriage in any way during the Competitions. An Athlete may be secured by rope, webbing or belt provided one end is held by a Groom and not wrapped or fastened to the Carriage in any way. Failure to comply will result in Elimination.
  - 2.7.1 Para Driving: A Para Driver may be attached on the carriage for support with a lap belt or a 4 (or 5) point belt, but there must be a quick release system.
  - 2.7.2 For Para Driving Athletes, in addition ref. To FEI Annex 8.
- 2.8 Substitution of a groom during the Marathon Competition is not permitted under any circumstances, and will incur Elimination of the Athlete.
- 2.9 In Dressage (as part of the test) and Cones, Athletes will be required to salute the Jury, unless time or layout of the Course prevents it.
- 2.10 Passengers may not ride on the carriage during any Competition. It is strongly recommended that no passengers under the age of 14 years old are permitted on the carriage during the Prize- giving ceremony.
- 2.11 Each time an Athlete dismounts he will incur 20 penalties.
- 2.12 Athletes will incur penalties each time one or both Grooms dismount. Five (5) penalties on the first occasion, 10 penalties on the second occasion. On the third occasion the Athlete is Eliminated, except in Marathon (see [EC. 964.5](#)).
- 2.13 *At **EC-recognized** events, passengers – human or animal (service animals exempted) – may not ride on the vehicle during any Competitions.*
- 2.14 *At **EC-recognized** events, a groom is optional for all single turnouts at all times at the event location except for Turnouts with an equine 120 cm. or taller competing on the Marathon course. For rules specific to grooms for junior drivers, see [Articles C102.6 and C943.2](#). If a groom is required by the organizer for any training, preliminary or intermediate entries, or advanced driving trial or combined test entries, this requirement must be*

*published in the prize list.*

**2.15** *At EC-recognized events, an Adult competitor may drive a single VSE or Small Pony turnout alone in all Competitions. A Junior C competitor may drive a single VSE turnout alone in all Competitions*

**2.16** *At EC-recognized events, the following table applies for Training, Preliminary and Intermediate divisions and for VSE and Small Ponies in Advanced Dressage tests and Cones competitions.*

CLASS		GROOMS		WHEELS	WT / WIDTH
		DRESSAGE & CONES	MARATHON		
FOUR-IN-HAND OR UNICORN	Horse, Pony	2 behind	2 behind	4	No minimum weight or width
	Small Pony, VSE	1 behind	1 behind		
PAIR	Horse, Pony, Small Pony, VSE			1 behind or beside	
TANDEM	Horse, Pony, Small Pony, VSE	None required	None required		
SINGLE	Horse, Pony			None required	None required
	Small Pony, VSE				

**2.17** *At EC-recognized events, the same driver must drive the entry in all Competitions at the Event (except as noted in 2.17.1). Athletes or Grooms may participate in any Competition more than once at any Event, subject to scheduling requirements, unless otherwise stated in the Prize List*

**2.17.1** Organizers may create a “Partner Entry” classification for any CDE, DT or AT allowing two named and qualified Athletes to elect between themselves who will drive in each of the three competitions. Entries in this classification will be eligible for class and separate competition awards (if offered) but not be eligible for overall event placings or awards.

**2.18** *Athletes (except VSE and Small Pony turnouts) competing in classes offering Advanced Dressage and Cones must follow all FEI requirements pertaining to Athlete and Groom participation*

## ARTICLE C944 IDENTIFICATION NUMBER

### 944.1 Athlete

Athletes will be allocated an Event Number per turnout on arrival and will retain that number throughout the Event. The number must be displayed on any Carriage used during the Competitions and also while schooling or exercising.

*At EC-recognized events held in conjunction with FEI events, an identification number with a different background color or numbering scheme that differentiates the WX entries from the /FEI entries will be suggested as specified in this article.*

### 944.2 Horse

Horses must be issued with a letter from A to F which follows the Athlete’s Identification Number on arrival at an Event. This number must be attached to the left side of the Horse (Pairs and Fours should have them, visible, on the outside when in harness) at all times within the Showgrounds, when it is

outside its stable.

*At EC-only recognized events, the provisions of this paragraph may be relaxed.*

#### **944.3 Penalties**

Failure to display the Event Numbers of Athletes or the identification numbers of Horses will incur a warning for the first occurrence. A repeated offence will incur a Yellow Warning Card issued by the President of the Ground Jury or the Chief Steward.

### **ARTICLE C945 OUTSIDE ASSISTANCE**

#### **945.1 Definition**

Any physical intervention by a third party, not riding on the carriage, whether solicited or not, with the object of facilitating the task of the Athlete or helping his Horses, is considered to be outside assistance.

#### **945.2 Prohibited outside assistance**

*At EC-recognized events, no person, either on or off a competing carriage entry may give verbal or physical directions to an Athlete with the exception of the person on the carriage during Marathon competitions. Athletes receiving verbal or physical assistance except for permitted outside assistance as listed in Article C945.3 shall be eliminated at the sole discretion of the Ground Jury.*

#### **2.1 Dressage and Cones:**

- 2.1.1 Any physical intervention by a third party, not riding on the carriage, whether solicited or not, with the object of facilitating the task of the Athlete or helping his Horses, is considered to be outside assistance. Any Athlete who has received outside assistance may be eliminated by the Ground Jury.
- 2.1.2 In Dressage, Grooms must remain seated in their proper positions between entering and leaving the Arena. They are not permitted to handle the reins or the whip (will incur 20 penalties). For Dressage, to speak or indicate the course to the Athlete is not permitted (will incur 10 penalties). However the Groom may handle the reins, whip and brake without penalty provided the carriage remains stationary.  
*At EC-recognized competitions, if the carriage does not have a safe groom seat, the judge may grant permission for the groom(s) to stand with no penalty*
- 2.1.3 Exception: If the bell has been rung by the Judge and the Athlete has failed to hear the bell; the Groom may advise the Athlete that the bell has been rung.
- 2.1.4 Athletes and Grooms may not use any form of electronic communication equipment during Dressage and Cones, subject to elimination.
- 2.1.5 Para Driving Athletes from nominated profiles may compete with the whip held/used by groom, and/or the groom holding the finger loop, but must have this noted on the Masterlist following classification evaluation.  
*At EC-recognized competitions, the Para Athlete will be required to have the applicable dispensation. (See Article 1.8)  
Grooms of Para Driving Athletes must sit so that he/she can help in case of need. The event Organizer or the Technical Delegate has the right to disapprove the position of the groom on the vehicle.*

## 2.2 **Marathon:**

- 2.2.1 Obstacle observers, ground observers, timekeepers or any other Officials may not give directions, advice or information to the Athlete, while he is on the course in Marathon, in order to assist him. Exceptions: see *-C943*.
- 2.2.2 Any Athlete who has received physical outside assistance by a third party not riding on the carriage will be eliminated by the Ground Jury.

## 2.3 Penalties: see *-C969*.

### 945.3 **Permitted assistance**

The following are considered to be permitted outside assistance:

- Assistance during compulsory rests and in neutral zones between Sections.
- Assistance to avoid accidents.
- Assistance to Horses as a result of an accident inside an obstacle, providing the Grooms are dismounted.
- Assistance by the Groom whereby a Horse is led through an obstacle by the bridle ends of the reins while harnessed to the carriage in either Marathon or Cones, will incur 20 penalties for the assistance, in addition to the penalties for dismount.
- *At EC-recognized events for turnouts without a groom on the carriage, should groom assistance be needed, the driver may stop and ask for such assistance from any capable person, who may then act as a groom rendering the necessary help, and the turnout shall be penalized with the normal "groom down" penalty.*

## **CHAPTER 9 SUBSTITUTIONS**

### **ARTICLE C946 SUBSTITUTIONS**

#### **946.1 Substitutions before an Event**

- 1.1 If the Veterinary Commission/Delegate advises, and the Ground Jury concurs, that a Horse is not fit to take part, or in the event of an accident or illness of an Athlete and/or a Horse (substantiated by a certificate from an official recognized doctor and/or veterinarian), substitutions may be made provided the OC gives its approval up to one hour before the start of the first Horse Inspection.

*At EC-recognized events in which a First Horse Inspection is not required, the deadline for substitutions will be one hour before the first Competition.*

#### **946.2 Substitutions during an Event**

- 2.1 Athletes in Four-in-Hand classes may start each Competition with any four of their five (5) declared entries.
- 2.2 Athletes in Pair classes may start each Competition with any two of their three declared entries.
- 2.3 Athletes in Single classes must start each Competition with their single declared entry.
- 2.4 One Horse may be used by another Athlete in the same class after the first Horse Inspection if that Athlete has not presented a spare Horse and providing the borrowed Horse has not already been used in a Competition at the Event. This Horse must then stay with that new Athlete for the whole Event. In CAIOs and Championships, such Horse must be entered by the

same NF as the competing Athlete.

## **CHAPTER 10 – DECLARATION OF STARTERS – ORDER OF STARTING**

### **ARTICLE C947 DECLARATION OF STARTERS**

947.1 omitted

947.2 The declaration of starters may not take place before the end of the first Horse Inspection. *At EC-recognized events, the athlete must make the declarations*

947.3 At all CAI Events additional Horses may be brought to the Showgrounds at the discretion of the OC, provided they can be properly identified by an identifying coloured number which must be attached to the harness at all times when the Horse is out of the stable. The horses must comply with all the applicable requirements of the [FEI] Veterinary Regulations. The additional Horse must be presented and identified at the First Horse Inspection, where the FEI Chief Driving Steward, will also paint one hoof in a distinctive colour and ensure that the paint mark remains visible throughout the Event.

947.4 Except when [C-935.5.3](#) applies, any special request from Athletes regarding the starting order of their turnout(s) must be given to the Technical Delegate in writing within one hour after the Horse Inspection. All requests not handed in as per this article may not be considered.

*At EC-recognized events, deadline for special requests will be stipulated in the Prize List.*

### **ARTICLE C948 STARTING ORDER**

*At EC-recognized events, the starting order in all competitions may be set by the Organizing Committee in consultation with the Technical Delegate.*

## **CHAPTER 11 – DRIVEN DRESSAGE**

### **ARTICLE C949 GENERAL**

The objective of the Driven Dressage Test is to judge the freedom, regularity of paces, harmony, impulsion, suppleness, lightness, ease of movement and correct bending of the horses on the move. Athletes will also be judged on style, accuracy, and general control of their horses, and also on their dress, condition of their harness and Carriage and the presentation of their whole turnout.

### **ARTICLE C950 THE ARENA**

950.1 The Driven Dressage arena must be 100m x 40m and laid out in accordance with the Annexes for all classes at Championship and CAIO events and for all classes of Four-in-Hand at CAI Events, except Pony CAIOs and Championships where the size must be 80mx40m.

950.2 At CAI Events, a smaller arena, measuring 80m x 40m and laid out in accordance with the Annexes, may be used for all classes of Singles, Pairs, and pony Four-in-Hands, in which case the loops of the serpentine must be reduced from five to three.

*At EC-recognized events, the size of the arena to be used shall be as stipulated on the applicable Driven Dressage test. VSE classes may be driven in large*

*or small full size arenas of Annex 4, or in the following size-adjusted arenas: Tests requiring 40m x 80m arenas may be driven in 30m x 60m arenas; and tests requiring 40m x 100m arenas may be driven in 30m x 75m arenas. Driven figures shall be reduced in proportion to the size-adjusted arenas. Diagrams and letter placement are published in Combined Driving Appendix 9F. The prize list must indicate the size of arena to be used.*

950.3 In Youth categories, the Driven Dressage Arena must be 80 x 40 m. The Organizer must ensure that the arena is enclosed.

950.4 Organizers must ensure that arrangements are in place so that spectators cannot approach closer than 5 meters from the edge of the arena.

*At EC-recognized events, this rule may be waived at Management discretion. Where an indoor arena is being used, the rail defining the arena shall satisfy this rule.*

## **ARTICLE C951 DRIVEN DRESSAGE TESTS**

### **Approved Tests**

Details of approved FEI Driven Dressage Tests are shown on the FEI website. The schedules for all events must state clearly which of these Tests is to be used.

*At EC-recognized events, current EC Driven Dressage Tests must be used as published for Training, Preliminary and Intermediate divisions and for Advanced division in Arena Trials. Advanced divisions in Driving Trials and Hybrid divisions and CAC classes offering Advanced Dressage use appropriate FEI Driven Dressage Tests. Organizers may also offer FEI 1\* Dressage tests for EC Intermediate divisions. The tests to be used must be stated in the Prize List.*

## **ARTICLE C952 CONDITIONS**

### **952.1 Entering the Arena**

An Athlete who enters the arena before the starting signal or who fails to enter the arena within 90 seconds of the starting signal may be Eliminated, at the discretion of the President of the Ground Jury.

*At EC-recognized events, no Competitor may be required to drive before his scheduled time. (See Art.-C953.5).*

### **952.2 Memory**

The FEI Driven Dressage Test must be driven from memory. Speaking or indication given by a groom will incur 10 penalties (10 penalties can only be given once per Test).

*At EC Training division events, the dressage test may be called. If the test is called, it is the responsibility of the Competitor to arrange for a caller. Lateness and errors in announcing the test will not relieve the Athlete from having error penalties. Calling the test is limited to reading the movements as written, once only, from a position outside the arena. Additional reading of the movements may be penalized at the discretion of the Judge. A competition cannot require competitors to use callers employed by show management. Any outside assistance (other than calling a Training division test) is forbidden and will result in elimination.*

### **952.3 Lameness**

- 3.1 If the President of the Ground Jury observes a case of marked lameness, he must Disqualify the Horse and Eliminate the Athlete. There can be no appeal against this decision.
- 3.2 In doubtful cases, after the Athlete has finished his test, the President of the Ground Jury may have the Horse checked immediately by the Veterinary

Delegate outside the arena. The Horse will be checked while harnessed to the carriage. If the Veterinary Delegate confirms the lameness, the Horse must be disqualified and the Athlete eliminated.

- 3.3 In Competitions where additional Dressage arenas are being used, the duty of the President of the Ground Jury as indicated above shall fall under the responsibility of the Judge at C of the applicable arena.

## **ARTICLE C953 JUDGING**

### **953.1 Positions of Judges**

- 1.1 When there are five Judges officiating they may be seated at CRSVP, if there are three judges the places may be CBE or CEP or any letter around the arena depending on the driven Test and the Judge's best view. The President will decide the positions. For all CAI1\*, when there are two (2) judges officiating, they may be seated at C and B or C and E.
- 1.2 *At EC-recognized events, when there are two Judges, they must be seated at C (President) and either B or E. A third Judge shall sit on the opposite side of the dressage ring. If the second Judge is at B, the third Judge may sit at E or H. If the second Judge is at E, the third Judge may sit at B or M.*
- 1.3 *At events with five judges, the positions for the side judges shall be at 30 meters from the ends of the 100m arena or 20 meters from the ends of the 80m arena.*
- 1.4 *Judges shall observe all tests at one assigned position for all drivers within the same class.*
- 1.5 *If overall awards are presented for a division, all classes within the division must be judged by the same judges.*

### **953.2 Allocation of marks**

The Judges will allocate their marks individually. There will be no consultation among Judges once the Athlete has started the Test. Only the Judge at C may give penalties for incomplete presentation or incidents.

### **953.3 Multiple Turnouts**

Pairs, and Four-in-Hands, will be judged as a whole and not as individual Horses.

*At EC-recognized events, classes for Tandems and/or Unicorns may be included and judged as a whole and not as individual horses.*

### **953.4 Pace**

The definition of paces will apply to all types and breeds of Horses.

### **953.5 Start and Finish**

The test starts as the Athlete enters the Arena at A, unless otherwise stated, and Finishes with the final salute. Tests are not timed. The Athlete will leave the Arena at a trot.

*At EC-recognized events, competitors shall not be required to commence Dressage tests before their scheduled time.*

## **ARTICLE C954 MOVEMENTS AND THEIR DESCRIPTIONS**

### **954.1 Halt**

The Horse must stand square, straight and motionless, remaining on the bit.

### **954.2 Walk**

With a regular four-beat movement, the Horse, remaining in a light contact, walks energetically, supple, with even and determined strides with the hind feet touching the ground in front of the foot prints of the fore feet and stretching forwards downwards.



*At EC-recognized events,*

- a. *Working Walk: A regular and unconstrained walk. The horse should walk energetically and calmly with even and determined steps with distinct, marked, four equally spaced beats. The driver should maintain a light and steady contact with the horse's mouth. It is desirable to have the horse's hind hooves touch the ground in front of the prints of the front hooves.*
- b. *Walk Stretching the Frame (ADS Training Level Tests): A relaxed walk in which the horse is allowed the freedom to lower and stretch out his head and neck to the utmost. The reins must be long enough to allow for this stretch, however, they should not be loose enough to loop. It is desirable to have the hind hooves touch the ground in front of the prints of the front hooves.*
- c. *Lengthened Walk: This is a determined and ground covering walk than the Working Walk with the horse clearly lengthening and lowering the frame. The horse must flex his poll somewhat and is expected to reach for the bit into soft contact. The horse's hind hooves should touch the ground in front of the prints of the front hooves.*

### **954.3 Free Walk**

Same definition as for the Walk, but in addition, gaining ground as much as possible, clearly lengthening the frame and stretching forwards downwards.

### **954.4 Working Trot**

A forward, active trot with the horse on the bit, carrying himself in balance and rhythm with even, elastic steps and good hock action and clear impulsion. The steps of the hind feet must at least be touching the ground in the footprints of the fore feet.

*At EC-recognized events,*

- a. *Lengthened Trot: The horse lengthens the stride and frame with more thrust and push from the hindquarters than in the Working Trot. The horse's stride covers more ground while maintaining the rhythm, balance and contact. The horse's hind hooves should touch the ground in, or in front of, the prints of the front hooves.*
- b. *Trot Stretching the Frame: The horse gradually takes the reins, reaching forward and downward into light contact, while maintaining balance, rhythm, tempo and quality of the trot. The nose of the horse should lower to at least to the point of the shoulder while keeping the same rhythm and impulsion. The Athlete must keep the reins without losing the contact and bring the Horse back to the preceding elevation as soon as the stretching movement is completed.*

### **954.5 Collected Trot**

The horse remains on the bit and moves energetically forward with a greater degree of engagement, leading to an increased flexion of the hocks and fetlock joints and raising up with the forehand, thus allowing for more mobility and elevation of the strides. The neck will be raised and more arched, with the poll the highest part. The nose should not be behind the vertical, or the neck restricted. The hind legs should take more weight and cadence should be visible.

### **954.6 Extended Trot**

- 6.1 The Horse lengthens his stride to cover as much ground as possible as a result of greater impulsion from the hindquarters. The Athlete allows the Horse, remaining “on the bit” without leaning on it, to lengthen its frame to

gain ground, with the nose slightly in front of the vertical. The hind feet must clearly over track the prints made by the fore feet.

- 6.2 The Horse must remain in balance while maintaining the same rhythm with strides of equal size. Hurried strides are not asked for, and constitute a severe fault.

#### **954.7 Medium Trot**

Between the defined Working Trot and Extended Trot. The Horse lengthens his stride to cover less ground than asked for in the Extended Trot but more ground than asked for in the Working Trot as a result of greater impulsion from the hindquarters. The Athlete allows the Horse, remaining 'on the bit' without leaning on it, to lengthen the frame to gain ground, with the nose slightly in front of the vertical. The hind feet should overtrack the footprints made by the fore feet. The Horse must remain in balance while maintaining the same rhythm with strides of equal size. Hurried strides are not asked for, and constitute a severe fault.

#### **954.8 Working Canter**

- 8.1 A forward, active pace with regular strides of three time beat. The Horse, showing good balance, remains on the bit without leaning on the hand, and goes forward with light cadenced strides and good hock action.
- 8.2 A Canter to the right, for instance, will have the footfalls follow one another in the following sequence; left hind, left diagonal (simultaneously left fore and right hind), right fore, followed by a moment of suspension with all four feet off the ground before the next stride begins.

*At EC-recognized events, the Canter is to be performed on the "lead" that is the direction of travel.*

- 8.3 The quality of the Canter is judged by the general impression, and the regularity and lightness of the three-beat pace in a clear uphill tendency. The Horse must be on the bit and well engaged in the hindquarters with good hock action, and must have the ability to maintain his rhythm and natural balance throughout the movement and the transitions. The Horse must remain straight on straight lines and correctly bent on curved lines.

#### **954.9 Collected Canter**

Horse's strides are shorter than in working canter, the hocks maintain a clear impulsion and the hind legs take more weight; the point of gravity is moving backwards and the neck and poll coming up more and more with the nose always a bit in front of the vertical showing a clear uphill tendency and self carriage; the basic is a clear three beat and a light steady contact with suppleness and elasticity

#### **954.10 Extended Canter**

In extended canter the Horse covers as much ground as possible with obviously lengthened strides and frame; there should be no hurried strides and the nose should be always in front of the vertical not losing balance and uphill tendency. There should be clear transitions into and out of the extended canter.

#### **954.11 Reinback**

- 11.1 The Horse must walk backwards in a straight line, with the legs being lifted and set down in diagonal pairs. The Horse must remain on the bit, straight and not evade or resist the contact, the poll should remain the highest point.
- 11.2 Transition to the next movement must be immediate and smooth.

## 954.12 **Shoulder-In**

- 12.1 Shoulder-in for the Driven Horse is performed in Collected Trot. The leaders are positioned so that the outside leader's tail is in front of the head of the pole. The leaders' shoulders are taken to the inside with a constant angle of approximately 30 degrees and a slight but consistent bend in the neck. The inside hind leg strides forward into the line of the outside front leg so that the Horses are working on three tracks. Impulsion, rhythm and engagement must be maintained throughout.

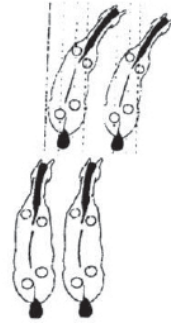

- 12.2 Too much bend in the neck results in loss of rhythm and suppleness. The wheelers must remain straight with no counter bend.

## 954.13 **Diagonal Yield**

Horse nearly parallel to Center line, crossing legs diagonally, hind direction diagonal front together, with slight flexion to the inside.

## 954.14 **Stretching the frame**

Athletes lengthen the reins gradually to the Horse(s) using a guided hand, to encourage and enable the Horse's neck to stretch forwards and downwards. As the neck stretches forwards and downwards, the Horse's mouth should reach the horizontal line corresponding with, but not lower than, the top point of the shoulder. An elastic and consistent contact with the Athlete's hands must be maintained and at no point should slack or loose rein be visible during the exercise. The same rhythm and impulsion will be maintained, and the Horse should remain light in the shoulders with the hind legs well-engaged. As soon as stretching of the frame has been demonstrated, the Athlete will bring the Horse(s) back to the preceding head carriage by retaking the reins during which the Horse must accept the contact without resistance in the mouth or poll.

## 954.15 **Transitions**

Changes of pace must always be made smoothly and promptly with the Horse remaining in balance and on the bit. A transition must be completed as the nose of the Horse arrives at the prescribed marker, unless otherwise stated.

## 954.16 **Change of Pace and Movement**

Changes of pace and movement are made when the heads of the leaders reach the point indicated in the test.

## 954.17 **Terminology**

The following must be considered when judging Driven Dressage movements:

- 17.1 Obedience and Lightness – willing response to aids without resistance and correctness of bend.
- 17.2 Regularity – the regularity, evenness and rhythm with which the Horse puts his feet to the ground.
- 17.3 Contact – the connection through the reins between the Athlete's hands and the Horse's mouth. It should be soft and steady at all times.
- 17.4 Impulsion – the willingness of the Horse to go forward energetically at all times and to respond quickly and evenly to changes of pace. The Horse must remain in balance while maintaining the same tempo with strides of equal size.
- 17.5 Straightness – carrying the head, neck and body in a straight line with the weight evenly divided among the legs. On curved lines the hind legs need to

- follow the footprints of the forefeet (no escaping or swinging out.)
- 17.6 Collection – roundness and engagement with good hock action, elevated poll allowing the shoulders to move with ease. The Horse’s energy is contained in a more deliberate pace than the Working Trot. The haunches are more compressed, the croup is lowered and the forehead elevated to the same degree. The stride is shorter but more powerful than the Working Trot and the front legs will move from the shoulder with greater agility resulting in lightness and greater mobility throughout. The neck should be more arched. The shortening of the frame is not and never should be a result of pulling back but rather of asking and allowing the Horse to move forward into the Athlete’s hand.
- 17.7 Accuracy – Correctness, roundness and correct size of figures and lines (including corners) as asked in the Test.

## **ARTICLE C955 GENERAL IMPRESSION**

### **955.1 Principle**

There are two boxes at the end of the Judges Score Sheets for marks on Athlete and General Impression and Presentation observed by the judges throughout the whole test.

*At EC-recognized events using ADS-published driven dressage tests, the judge(s) shall record marks and comments on each of the applicable collective remarks: Gaits, Impulsion, Submission, Driver, and Presentation when indicated on the score sheet.*

#### **1.1 Gaits**

*Regularity and freedom (if Four-in-Hand, or Pair, maintenance of pace by all horses). The quality of paces in each movement is marked under the appropriate movement. The mark for the general impression must reflect paces and transitions during the whole test.*

#### **1.2 Impulsion**

*Moving forward, engagement of the hind quarters (if Four-in-Hand or Pair, all Horses working). The level of impulsion may vary between movements and pace, but the mark for impulsion must reflect the performance of the Horses throughout the Test, in all trot and canter paces.*

#### **1.3 Submission**

*Response to aids – willing and without resistance, correctness of bend, suppleness, acceptance of the bit.*

### **955.2 Athlete (EC Driver)**

- 2.1 Use of aids, handling of reins and whip, position on the box, accuracy of figures. The mark must reflect the consistent level of accuracy and quality of transitions.
- 2.2 Para-Driving Athletes in able-bodied competitions. Athletes may salute with a nod of their head only. Hats must not be removed at the salute, and contact must be maintained on the reins during the halt and salute.

### **955.3 General Impression and Presentation (EC Presentation)**

- 3.1 Appearance of driver Athlete and grooms, correctness, cleanliness harmonizing with or harness and carriage. Fitness, matching and condition of Horse(s), balanced picture of the complete turnout. Cleanliness and fit of harness. Harmony between Horse(s) and Athlete.

*At EC-recognized events, Presentation is defined as:*

*Appearance of driver and grooms: cleanliness, fitness, and condition of horses, harness and vehicle.*

## ARTICLE C956 SCORING

### 956.1 Marks

- 1.1 Marks out of 10 will be awarded for each numbered movement and for each heading under General Impression on the following basis:

10: Excellent	4.0: Insufficient
9.0: Very Good	3.0: Fairly Bad
8.0: Good	2.0: Bad
7.0: Fairly Good	1.0: Very Bad
6.0: Satisfactory	0: Not Executed
5.0: Sufficient ( <i>Marginal</i> )	

- 1.2 Half marks may be awarded.

### 956.2 Error of Test

If an Athlete attempts to perform a movement, or attempts to maintain the pace required, and fails to do so, but does not deviate from the track, the President of the Ground Jury may either treat it as an “Error of Course” (see paragraph 3 below), or he may decide to leave the Judges to give the movement an appropriate mark. If an Athlete makes no effort to perform a movement in a Test then it may either be treated as an Error of Test or as an Error of Course at the discretion of the President of the Jury

### 956.3 Error of Course

- 3.1 An “Error of Course” is when an Athlete deviates from the required track or when a movement is performed at the wrong pace, or omitted altogether.
- 3.2 In the event of an Athlete making an Error of Course, the President of the Ground Jury will ring the bell and stop the Athlete. The Athlete must then resume the Test from the beginning of the movement where the error was made. If the Athlete is in any doubt, he may ask the President of the Ground Jury for guidance, without incurring any penalties.

### 956.4 Disconnected or Broken Harness

If the reins, pole strap, chains or trace become disconnected or broken, or should the Horse get a leg over the pole, trace or shaft, the President of the Ground Jury must ring the bell and a Groom(s) must dismount and reconnect or repair as appropriate. The Athlete will be penalized for a Groom(s) dismounting.

### 956.5 Disobedience

Any resistance in the forward movement, kicking or rearing is considered to be disobedience and will be penalized by the Judge at C, as follows:

- 1st Incident.....5 penalties  
2nd Incident..... 10 penalties  
3rd Incident.....Elimination

### 956.6 Carriage overturn

A Carriage overturning is elimination.

## ARTICLE C957 SUMMARY OF DRIVEN DRESSAGE PENALTIES

Athletes are liable to the following penalties:

DESCRIPTION	REF. ARTICLE	PENALTIES
Part of the turnout leaving the arena during a movement		Mark down for inaccuracy
The whole turnout leaving the arena		Elimination
Athlete dismounting	<a href="#">943.2.10 &amp; FEI Annex 10</a>	20 penalties
Entering the arena without a whip	<a href="#">928.4.4</a>	5 penalties
Dropping or putting down a whip	<a href="#">928.4.4</a>	5 penalties
No breeching if carriage has no brakes	<a href="#">937.1.1</a>	Elimination
No breeching for Singles	<a href="#">940.1.14</a>	Elimination
Use of bandages or brushing boots (Horse to be inspected after Test)	<a href="#">940.2</a>	10 penalties
Contravening the Rules on Advertising	<a href="#">941</a>	Yellow Warning Card
Person tied to the carriage	<a href="#">943.2.7</a>	Elimination
If a Groom handles the reins, brake or uses the whip	<a href="#">943.2.4</a>	20 penalties
Groom speaking or giving indications (see exceptions)	<a href="#">945.2, 952.2/945.2.1.1</a>	10 penalties (once) (possible elimination)
Physical outside assistance	<a href="#">945.1</a>	Elimination
Groom(s) dismounting First incident Second incident Third incident	<a href="#">943.2.11 &amp; FEI Annex 10</a>	5 penalties 10 penalties Elimination
Early or late entry	<a href="#">952.1</a>	Possible Elimination
Lame Horse	<a href="#">952.3</a>	Disqualification of the Horse and elimination of the Athlete
Incomplete presentation (Athlete, Groom, Carriage)	<a href="#">Art. 928</a>	5 penalties
Errors of course: First occasion Second occasion Third occasion	<a href="#">956.3</a>	5 penalties 10 penalties Elimination
Disobedience: First incident Second incident Third incident	<a href="#">956.5</a>	5 penalties 10 penalties Elimination
Carriage overturn	<a href="#">956.6</a>	Elimination

## ARTICLE C958 CLASSIFICATION

### 958.1 Total Marks

- 1.1 The individual marks awarded by each Judge for each movement and for General Impression will be added together and divided by the number of Judges to obtain the average score.
- 1.2 In order to adjust the influence of Driven Dressage on the whole event, where the total possible marks for the test are greater than 160, the average score will be multiplied by the coefficient printed on the score sheet to obtain the adjusted average score to be used in the results.  
*At EC-recognized events using ADS Driven Dressage tests, points will be awarded and scores calculated as indicated on the applicable test form. See Art. C956.*
- 1.3 Penalties are only awarded by the President of the Ground Jury at C. Any penalties will be deducted from the average adjusted score and the final total will be deducted from 160 to obtain the penalties for the test.
- 1.4 Scores will be calculated to two decimal places.
- 1.5 The Athlete with the lowest score in penalties will be the winner Driven Dressage.
- 1.6 *Score sheets for EC-recognized events may be found on the EC website*

### 958.2 Classification at EC-recognized Dressage competitions

- 2.1 *Total Points awarded by each Judge will be added together and divided by the number of judges to obtain the Average Total Points (to two decimal places). The Average Total Points is then multiplied by the Factor indicated on the individual test. Conversion to Penalty Points is achieved by subtracting the Factored Average Total Points from 160. Total Penalties Points are determined by adding any penalties imposed by the Judge at C to Penalty Points.*
- 2.2 *Placings in the Driven Dressage competitions:*
  - a. *in Arena Trials and Driving Trials – awarded to competitors in ascending order starting with the lowest Total Penalties.*
  - b. *The Competitor with the lowest combined penalties for Dressage and Presentation will be awarded to competitors in ascending order starting with the lowest combined penalties.*
- 2.3 *Placings in Dressage-only events, the final scores may be expressed in positive points for High Point awards, as a percentage of the maximum possible points, or as penalty points.*
  - a. *High Point awards are the highest Average Total Points less any penalty points imposed by the Judge at C, placed in descending order.*
  - b. *Percentage awards are the highest Average Total Points less any penalty points imposed by the Judge at C, expressed as a percentage of the maximum possible points, placed in descending order.*
  - c. *Penalty Point awards are the lowest Total Penalties placed in ascending order.*

## CHAPTER 12 MARATHON

### ARTICLE C959 GENERAL

The objective of Marathon is to test the fitness, stamina and training of the Horses, and the driving skill and general horsemanship of the Athlete.

### ARTICLE C960 THE COURSE

#### 960.1 General

- 1.1 Maximum Distances and speeds must not be exceeded.
- 1.2 These speeds may be reduced by the Technical Delegate and the President of Jury in the case of adverse weather or ground conditions.
- 1.3 *At EC-recognized events, the FEI provisions of this paragraph do not apply.* In CAI2\* and 3\* the Course must consist of two or three Sections. In CAIO4\* and above, the Course must consist of three Sections. The distance must be as close to maximum distance as possible for Championships.  
*At EC-recognized events, the Sections are A, Transfer, and B.*
- 1.4 The actual distance and time allowed in the Transfer section to be confirmed by the Technical Delegate in conjunction with the President of the Ground Jury.
- 1.5 The total distance in Section B should be approximately one (1) km per obstacle and preferably not less than 700 m between two consecutive obstacles. The total distance in Section B must include the distances through the obstacles.
- 1.6 The distances between the end of one Section and the start of the next must not be included in the total length and time of the course.
- 1.7 As an alternative option to the Phase A there can be used a controlled Warm-up (min 30 minutes before starting time) in a designated warm-up arena with minimum 7000 square metres, properly stewarded, with a judge and veterinarian in attendance. A marathon-type obstacle for preparation purposes should be provided. Horse inspection and bit/harness control 10 minutes before the start in Section B is compulsory.

#### 960.2 Marathon sections:

*Note: At EC-recognized events for Marathon speeds, distances and pace, see tables C960.2.8 and C960.2.9 below. Drivers shall accumulate penalties for being under the minimum time in Sections A and/or B, and over the Time Allowed in all Sections. Exceeding the Time Limit in any Section shall incur elimination.*

- 2.7 *At EC-recognized events:*
  - a. *Training Marathon competitions other than Driving Trials, Sections A, Transfer and B must be used with a total distance up to 12.5 km, with up to five obstacles with no more than three gates each.*
  - b. *Preliminary Marathon competitions other than Driving Trials, Sections A, Transfer and B must be used, and the total distance to be between 8-14 km, with up to six obstacles with no more than four gates each.*
  - c. *Intermediate Marathon competitions other than Driving Trials, Sections A, Transfer and B must be used, and the total distance to be between 10.8-15 km with five to seven obstacles with no more than five gates each.*
  - d. *The Controlled Warmup option may be used in place of Sections A and Transfer in the above events at the Organizer's option provided the*



specifications are published in the Prize list. With this option, the minimum total distance may be reduced to one kilometer per obstacle used in Section B.

- e. Driving Trials, only Section B is used, with a total distance of up to 10 km.
- f. Organizers have the option of a 2 section marathon, see 960.2.8.1

## 2.8 Distances and Pace at EC-recognized Marathon competitions:

DIVISION	TOTAL DISTANCE		PACE			
	MIN KM	MAX KM	SECTION A	TRANSFER SECTION*	SECTION B <sup>1</sup>	
					OUTSIDE OBSTACLES	INSIDE OBSTACLES
Training	8 <sup>2</sup>	12.5	Any pace	Any pace	Walk or trot only	Walk or trot only
Preliminary	8 <sup>2</sup>	14	Any pace	Any pace	Any pace	Any pace
Intermediate	10 8 <sup>2</sup>	15	Any pace	Any pace	Any pace	Any pace
Advanced	11 8 <sup>2</sup>	18	Any pace	Any pace	Any pace	Any pace

1) All divisions – Walk or trot only from last obstacle or last 300m to end of Section B, see 2 and  
 2) \*The Transfer Section minimum distance is 800 meters and the maximum distance is 1500 meters  
 3) See 960.2.7(d) whenever Controlled Warmup option is used

### 2.8.1 EC Option – Two-section Marathon

DIVISION	MAX DISTANCE	MIN DISTANCE	PACE	SPEEDS KPH			
				HORSE	PONY	SM PONY	VSE
Training	Sect A 6500 m	5800 m	Free	10-12	9-11	8-10	5.5-7.5
	Sect B 6000 m	4000 m	Walk/Trot	13-14	12	11	9
Preliminary	Sect A 6500 m	5800 m	Free	10-12	9-11	8-10	6-8
	Sect B 7000 m	5000 m	Free	14	13	12	9.5
Intermediate	Sect A 6500 m	5800 m	Free	11-13	10-12	9-11	6.5-8.5
	Sect B 8000 m	7000 m	Free	14	13	12	10

\*The actual speed for Section A will be determined by the Technical Delegate and Course Designer based on length of the track and allowing incorporation of at least 800 meters walking at appropriate speed.

## 2.9 Speeds at EC-recognized Marathon competitions:

SPEED SKPH	TRAINING			PRELIMINARY			INTERMEDIATE			ADVANCED		
	Sec A	Trsfr	Sec B	Sec A	Trsfr	Sec B	Sec A	Trsfr	Sec B	Sec A	Trsfr	Sec B
Horses <sup>1</sup>	14	—	13	14	—	14	15	—	14	15	—	14
Ponies <sup>1</sup>	13	—	12	13	—	13	14	—	13	14	—	13
Small Ponies <sup>1</sup>	12	—	11	12	—	12	13	—	12	13	—	12
VSEs <sup>1</sup>	9	—	9	10	—	9.5	10	—	10	10	—	10

**Note:** The Organizing Committee, with the approval of the Course Designer and Technical Delegate, has the right to lower speeds and distances to suit

*the weather, terrain, footing, the experience of competitors, or the size and/or condition of the animals.*

*At EC-recognized events with Section A, VSE entries in Training and Preliminary divisions may compete on a shortened course. VSE entries in Intermediate and Advanced divisions must use the full course.*

### **960.3 Compulsory rests**

A safety check of the turnout must be made by the Steward and the Veterinarian before the start of Marathon and during the 10-minute hold at the end of the Transfer Section (Option 1) or Section A (Option 2).

*At EC-recognized events, the format of the required safety check at the Rest Stop is at the discretion of the President of Jury and Technical Delegate, under the direction of the Ground Jury.*

- 3.1 There must be a compulsory rest of not less than 10 minutes in the designated rest area prior to the start of Section B. When Section A is a "controlled Warm-Up", the compulsory rest may be reduced to 5 minutes.
- 3.2 The area of the compulsory rest should, if possible, provide some shade and must be large enough to accommodate three turnouts at once and have room for additional motor vehicles.
- 3.3 Water must be provided at the rest area for the Horses.
- 3.4 *At EC-recognized events, a blacksmith (farrier) may be present or on call at the discretion of the Organizing Committee.*
- 3.5 Para Driving: quick release systems to secure a wheelchair and lap belts or 4 points belts with a quick release system must be checked by the Technical Delegate and/or the Chief Steward before the start of the marathon.
- 3.6 In exceptional circumstances, the minimum time required for the Compulsory Rest may be increased by the President of the Jury in consultation with the Technical Delegate.
- 3.7 If a Horse is not accepted by the Veterinarian at the rest area after 10 minutes, or 5 minutes for a "controlled warm-up", the Horse and Athlete will be Eliminated.
- 3.8 Turnouts may stand, walk or trot within the rest area.

### **960.4 Section and direction signs**

- 4.1 The beginning and end of each Section must be marked with a pair of Red and White flags.
- 4.2 The entire Course must be clearly marked with yellow direction markers placed, wherever possible, on the right hand side of the track to be clearly visible to the approaching Athlete. A confirmation directional arrow must be placed after every significant turn.
- 4.3 Sections A and B must have a marker at every kilometer. In Section B the measurement of the kilometers must include the distances through the obstacles.

*EC marathon courses: when multiple divisions with different distances are used in Sections A and/or B, the kilometer markers shall be color-coded and shaped to match division Compulsory Turning Flags as described in [C960.5](#)*

- 4.4 The marker for a kilometer occurring within an obstacle should be placed on the post supporting the red exit flag.

### **960.5 Compulsory turning flags**

- 5.1 Sufficient red and white compulsory turning flags must be positioned on the Course to ensure that all Athletes follow the designated track. Athletes must leave the red flags on their right and the white flags on their left. These

compulsory turning flags must be numbered consecutively in each Section and they must be placed so they are clearly visible to Athletes from a reasonable distance.

*At EC-recognized events, numbered kilometer markers and compulsory turning flags shall be distinguished by the following colors. Distinctive shapes are also highly recommended. Numbers may be black or white to provide maximum contrast:*

*Training division – diamond – white or black background  
Preliminary division – square – green background  
Intermediate division – circle – red background  
Advanced division – triangle – blue background  
VSE classes – octagonal – orange or purple background*

*At EC-recognized Training and Preliminary division events, there shall be no Compulsory Turning Flags positioned on significant slopes. A relatively easy alternate route shall be provided. At Intermediate division events, Compulsory Turning Flags may be positioned on moderate slopes.*

- 5.2 The location and number of the Flags must be marked on the map of the Course to clearly indicate the correct route to be driven between the compulsory turning flags before and after each obstacle. In addition, a list showing the order for driving compulsory turning flags and obstacles must be provided for Athletes and Officials.
- 5.3 Ground Observers must record the Athlete's track through the compulsory turning flags; if any compulsory turning flags are missed out or passed in the wrong sequence, the details must be reported to the member of the Ground Jury or Technical Delegate as soon as possible.

#### **960.6 Paces**

- 6.1 The finish of Section B must not be more than 300 m from the exit of the last Obstacle unless the Technical Delegate grants an exception. If the last obstacle is situated within 300 m of the finish, the Athletes may stop within 30 m of the out gate of the obstacle to repair a broken or detached harness without penalty. A 30 m marker will be placed on the track to indicate this point if the last obstacle is within 300 m of the finish.
- 6.2 Between the 30 meter sign of the last obstacle (or 300 m) and finish, pace must be trot or walk only. The Athlete will accumulate one penalty point for each five seconds the turnout is not at the walk or trot. See Article C960 & appendix 9E (quick reference)

#### **6.3 Transfer Section**

*At EC-recognized events, gates, sharp turns, water and steep hills should not be included in the transfer or walk section.*

#### **960.7 Cool Down Area**

At the end of Section B, a cool down area (Arena, Loop, or Track) of a minimum of 800m and a maximum of 1200m must be installed. The in-harness examination, as per Art 935.5 must be performed between ten and fifteen minutes after the Athlete has entered the cool down area. The groom(s) may walk beside the carriage in this area. An Athlete that fails to present his turnout at the cool down area will be eliminated. Brushing boots and bandages may be removed from the horses.

*At EC-recognized events, the cool down area will remain an option prior to the in-harness inspection at the end of Section B.*

## ARTICLE C961 OBSTACLES IN SECTION B

### 961.1 Number of Obstacles

*1.1 At EC-recognized events, see C960.2.7.*

### 961.2 Sketches of Obstacles

Accurate sketches of each Obstacle, showing the location of the compulsory gates, Dislodgeable/Detachable Elements and Entry/Exit Flags must be made available to Athletes, team and Event Officials before the first inspection of the Course.

### 961.3 Design and Construction of Obstacles

- 3.1 The number of each Obstacle must be clearly displayed on the post supporting the Red Entry Flag.
- 3.2 The Entry and Exit of each Obstacle must be marked by Red and White Flags (red on the right and white on the left), not less than 20 m from the nearest lettered gate, unless the Technical Delegate grants an exception. After the finish line of each obstacle a 30 m sign must be established. A dismounted groom in an obstacle must be back on the carriage before the rear axle passes the sign. The entry and exit of each obstacle for VSE classes may not be less than 15m from the nearest compulsory gate unless the Technical Delegate grants an exception.
- 3.3 The track through an Obstacle should not exceed 250 m on the shortest, 2.5 m drivable route that is not narrower than 2.5 m at any point, between the entry and exit flags. The track may exceed 250 m in exceptional circumstances, at the discretion of the Technical Delegate.
- 3.4 Obstacles must be at least 700 m apart. The Technical Delegate may grant an exception.
- 3.5 Obstacles must be clearly numbered in the sequence in which the Athletes are required to drive them.
- 3.6 Obstacles must not include any feature which might cause damage or injury to the Horses.
- 3.7 Artificial obstacles should be solidly constructed and firmly fixed, so that they are unlikely to be moved or broken during the Competition.
- 3.8 If the Course Designer includes any element in an obstacle, which in the opinion of the President of the Jury and Technical Delegate could frighten the Horses, an alternative route must be provided within the Obstacle.
- 3.9 Where a constructed water crossing is included in an obstacle, the depth of the water must not be more than 30 cm. Where natural water is used the Technical Delegate may allow a maximum depth of 50 cm. The bed of any water crossing must be firm. Where water depth exceeds 50 cm a substantial fence, firmly fixed, must be constructed to prevent Horses going into deep water.

*At EC-recognized events, Training division, unless specified in the prize list, must have a dry, measured, legal, optional route through water obstacle gates.*

- 3.10 If a barrier for crowd restraint is required, by local regulations or the Organizer, it must not be positioned closer than 20 m from the nearest element in the obstacle, unless the Technical Delegate grants an exception.

### 961.4 Compulsory gates

- 4.1 Obstacles include compulsory gates marked with red and white letters, which should be marked A up to F, indicating the sequence in which they must be driven. At Canadian competitions where obstacles are used for more than one Division, the compulsory gates may be marked with blue (for

red) and yellow (for white) markers for Training Division only, when approved by the Technical Delegate. At Canadian competitions one obstacle may have unlettered red and white gates, driven in any sequence provided the obstacle sketch (Article C961.2) shows a dashed line connecting pairs of markers forming each of the gates.. )

4.2 As an alternative option, a maximum of two letters can be used twice in the same obstacle.

4.3 The height of all elements within a compulsory gate must not be less than 1.30 m.

*At EC-recognized events, minimum height for gates and elements for VSE classes is 1.0 metre unless an exception is granted by the Technical Delegate.*

4.4 The minimum width of a compulsory gate is 2.50 m.

*At EC-recognized events, the minimum width of a compulsory gate for VSE classes is 2.0 metres.*

4.5 *At EC-recognized events, for Training and Preliminary divisions, no compulsory gates may be positioned on a significant slope. At Intermediate division, moderate slopes are allowed.*

### 961.5 Dislodgeable/detachable elements

5.1 The Course Designer may choose any type of dislodgeable/detachable element with a preference for balls such as used in Cones.

5.2 All dislodgeable/detachable elements may not interfere with, or cause injury to the Horse or damage to the carriages, when they are dislodged.

5.3 The cups that hold the ball on a dislodgeable element should be a standard 45-55mm pipe to hold the balls from the cone driving Competition. The cups must be of sufficient depth so that the ball does not rest on the post.

5.4 The number of dislodgeable/detachable elements must not exceed 24 in total. Athletes will incur two penalties for each element dislodged.

*At EC-recognized events, the number of dislodgeable elements is not limited, subject to the approval of the Technical Delegate.*

5.5 A dislodgeable/detachable element is “live” at all times until it is dislodged or completely detached.

5.6 An Athlete or Groom who attempts to prevent a dislodgeable/detachable element from being dislodged will incur 10 penalties.

### 961.6 Obstacles in a Combined Marathon course

6.1 Width of cones - the following clearances shall apply:

Division	Class	Cones Width
Horse	Four-in-hand	1.80m to 1.90m
	Pair	1.70m to 1.60m
	Single	1.50m to 1.60m
Pony	Four-in-hand	1.70m to 1.60m
	Pair	1.50m to 1.60m
	Single	1.40m to 1.50m

- 6.2 Marathon-type obstacle width of gates - the following clearances shall apply:

Division	Class	Cones Width
Horse	Four-in-hand	3.50m to 4.00m
	Pair	3.50m to 4.00m
	Single	3.00m to 3.50m
Pony	Four-in-hand	3.00m to 3.50m
	Pair	3.00m to 3.50m
	Single	3.00m to 3.50m

## ARTICLE C962 INSPECTION OF THE COURSE

### 962.1 Visit of the Technical Delegate

At least 48 hours before Marathon, the entire Course, including the obstacles, must be available for inspection and approval by the Technical Delegate.

### 962.2 Briefing for Athletes and Officials

- 2.1 The Technical Delegate must arrange a briefing for members of the Ground Jury and the Chefs d'équipe (Athletes at CAI Events) prior to the official opening of the Course.
- 2.2 Ground Observers, obstacle observers and time keepers must be briefed by the Technical Delegate or his designated representative before the start of Marathon.
- 2.3 Copies of maps of the entire Course must be available at the briefing, for those requiring them. The maps must show each Section, the location of all the Obstacles and numbered compulsory turning flags, kilometre markers, and any areas of the Course which are closed to motor vehicles.
- 2.4 Drawings of the obstacles must be available for chefs d'équipe, Athletes and Officials during the briefing.
- 2.5 A list showing the order for driving compulsory turning flags and obstacles must also be made available.

### 962.3 Inspection of the Course by Athletes.

- 3.1 At least 48 hours before the first Athlete is due to start Marathon, the whole Course must be open for inspection by the Athletes, except under exceptional circumstances, when Organizers have the option not to open Section A for inspection, with the agreement of the Technical Delegate.  
*At EC-recognized events, the course must be available for inspection by the Competitors at least 24 hours before the start of the Competition. (For Arena Trials see Appendix 9B)*
- 3.2 The Technical Delegate may impose restrictions on the means of access to certain parts of the Course.
- 3.3 The course is closed for inspection from the time the first Athlete starts Section A or Controlled Warm-up. The Obstacles in Section B may be left open until the first Athlete starts Section B.
- 3.4 Athletes using motor vehicles must remain on the roads and tracks designated by the Technical Delegate.
- 3.5 The Obstacles may only be inspected on foot. No motor vehicles or bicycles may be taken inside any part of an obstacle and the Controlled Warm-up. Failure to comply will be penalized by the issue of a Warning for the first infringement and a Yellow Warning Card for the second.

3.5.1 Para Driving Athletes from nominated profiles may use a Motor Vehicle to walk the course (MVWC) but must have this noted on the Masterlist following classification Evaluation.

*At EC-recognized events, the Para Athletes must present their dispensation to the Organizer prior to the competition to be exempt from this Article, and their vehicles must be clearly identified.*

- 3.6 *At EC-recognized events, Drivers with limited mobility due to physical disabilities will be permitted to drive themselves through marathon obstacles at a walking pace in golf carts or similar vehicles.*
- 3.7 No horse may be taken inside any part of an obstacle after it is officially gated by the course designer for that event .

## **ARTICLE C963 TIMES**

### **963.1 Timetable**

- 1.1 A timetable showing the start of Section A or Controlled Warm-up and the timetable of each Section, including the compulsory rest, must be drawn up by the OC for the Ground Jury and Technical Delegate. It must be adjusted in the event of unforeseen circumstances and redistributed.
- 1.2 A timetable showing the starting time for each Athlete on Section A or Controlled Warm-up must be provided to the Athletes and the timekeeper at the start of Section A or Controlled Warm-up. Running order lists must be provided to all other timekeepers, ground observers and obstacle observers.

### **963.2 Times in Sections**

- 2.1 The Time Allowed in all Sections is calculated according to the average speed selected for that Section.
- 2.2 The Minimum Time in Section A is two minutes less than the Time Allowed.
- 2.3 The Minimum Time in a Controlled Warm-up is two minutes less than the Time Allowed.
- 2.4 The Minimum Time for Section B is three minutes less than the Time Allowed.
- 2.5 The Time Limit for Section A, Controlled Warm-up, and Transfer section is the Time Allowed plus 20%. The Time Limit for Section B is twice the Time Allowed.
- 2.6 The Time Limit in the Cool Down area is minimum 10 minutes and maximum 15 minutes.
- 2.7 An Athlete who exceeds the Time Limit in any section will be Eliminated.

### **963.3 Timing**

- 3.1 Electronic timing equipment should be used for the timing of Athletes in each Section and the obstacles, whenever possible.
- 3.2 Timekeepers at the start and finish of each Section must record the start and finishing times for each Athlete on the Section Timer Record and enter the time on the Athlete's Marathon (Green) Time Card.

### **963.4 Start and finish**

- 4.1 Athletes should be at the start of Section A or Controlled Warm-up at least 10 minutes before their published Start Time.
- 4.2 If an Athlete is not ready to start Section A or his Controlled Warm-up at his scheduled time, the Timekeeper will start him at the earliest available time at his discretion, and record the actual starting time, which must be reported to the Technical Delegate and President of Jury, for onward transmission to the Scorer, at the earliest opportunity. The Athlete will be penalized 0.25 of a penalty per second of the time elapsed between his scheduled start time and the time he was ready to start, and he must not be allowed to start less than two minutes before the next Athlete's starting time. For the

avoidance of doubt, Athletes will not be penalized where the start of Section A is delayed for organizational reasons.

- 4.3 Athlete must start each section from the halt with the leading horse behind the start line. The Timekeeper will count down to the Start time. If an Athlete starts before the Timekeeper gives him the authorization, he will be recalled, a new start will be given and the Marathon Time Card will be amended. If the Athlete fails to stop when recalled, he may be Eliminated. A member of the Ground Jury must be made aware of the circumstances as soon as possible.
- 4.4 The timing of the section ends when the nose of the leading horse has passed the finish line. Section penalties will apply until the whole turnout has passed the finish line.

#### **963.5 Time Penalties in the Sections**

- 5.1 In Section A, Controlled Warm-up and Section B, Athletes will be penalized 0.25 of a penalty per second for exceeding the Time Allowed.
- 5.2 Athletes completing Section A, Controlled Warm-up and B in less than the minimum time will be penalized 0.25 of a penalty point for each second they are early.

### **ARTICLE C964 PENALTIES ON THE MARATHON COURSE**

#### **964.1 Whips**

Whips, if carried, may only be used by the Athlete. Failure to comply will incur 20 penalties. *At EC-recognized events, driving the Marathon without a whip in hand will incur 20 penalties. Inadvertently dropping the whip will not incur any penalties provided it is retrieved or replaced prior to passing the next Compulsory Turning Flag on course.*

- 1.1 Para Driving Athletes from nominated profiles may compete with the whip held/used by groom, but must have this noted on the Masterlist following classification evaluation.

#### **964.2 Error of Course**

If an Athlete fails to pass through a compulsory turning flag (CTF) in the designated sequence, he may return to the point of error and drive the CTF, provided he has not driven the following CTF or the next Obstacle. An Athlete who fails to pass through a CTF in the published sequence and direction will be Eliminated, (except multiple CTFs which are to be driven several times with different numbers).

#### **964.3 Deviation from the Course**

- 3.1 Athletes must not deviate from the track for the last 300 meters. Athletes who stop, circle, zig- zag or leave the track in any other way will incur 10 penalties for each occurrence.
- 3.2 Exception: See C-960.6

#### **964.4 Incorrect pace**

Should one or more Horses break into a canter within the last 300 m before the finish and this is not corrected within five seconds, the Athlete will incur one penalty for every occurrence. If the break continues, the Athlete will incur one penalty for every additional completed period of five seconds.

*At EC-recognized events, the above penalty also applies to:*

- *Walk Section – any pace other than walk (Training, Preliminary Intermediate)*
- *Section B (inside obstacles) – cantering (Training); and*
- *Section B (outside obstacles) – cantering (Training).*



- *Intentional break of pace as specified above shall incur elimination*

#### **964.5 Dismounting in the Sections**

- 5.1 During Section A, Controlled Warm-up and Section B (except inside the Obstacles), Grooms and Athletes are not allowed to dismount unless the carriage is stationary. If the vehicle is not stationary, either or both Groom(s) dismounting will incur five penalties. The Athlete dismounting will incur 20 penalties.
- 5.2 In the Cool Down Area only, Grooms may walk beside the Carriage.
- 5.3 The Athlete and all Grooms must be on the carriage as it crosses the Start and Finish lines and passes through the Compulsory Turning Flags in each Section (Section A, Controlled Warm-up and Section B). Failure to do so incurs five penalty points for grooms and 20 penalty points for the Athlete on each occasion.
- 5.4 In exceptional circumstances, if warranted due to the condition of the terrain or weather, the Technical Delegate and the President of the Ground Jury may permit Grooms in competitions for ponies and single horses to run behind their carriage on designated parts of the course.

*At EC-recognized events, the above paragraph also applies to VSE entries.*

#### **964.6 Stopping**

- 6.1 Athletes may stop for repairs to carriages or harness or for any reason beyond the Athlete's control, anywhere on the course other than while negotiating an obstacle, without incurring penalties, other than loss of time, except as in [EC-960.6](#).
- 6.2 Athletes will incur one penalty point for each commenced ten seconds that they remain stopped on the course for any other reason.
- 6.3 If an obstacle is situated within 300m of the finish line, an Athlete is allowed to stop to carry out necessary repairs to the harness or carriage (missing or disconnected trace, pole strap or reins) without penalty as long as he stops within the signed 30 meters after leaving the last Obstacle, as per [EC964.7.1](#). Stopping for any other reason between the last Obstacle or the 300-metre sign, whichever is closer to the Finish Line in Section B, will incur 10 penalties for each occurrence.

#### **964.7 Damaged Carriage/Harness**

- 7.1 At the Finish of Section B any missing or disconnected trace, pole strap or reins will incur 10 penalties for each occurrence.
- 7.2 At the Finish of Section B a broken or disconnected pole or shaft or bit will incur Elimination
- 7.2 Carriages must pass the Finish of Section B drawn by the number of Horses required for the designated class and on the designated number of wheels. Failure to comply will incur Elimination. Broken or missing tires are acceptable.
- 7.3 If the carriage overturns (on the course or in an obstacle), the penalty is Elimination and the Athlete may not continue on the Marathon.

### **ARTICLE C965 OBSTACLE PENALTIES**

#### **965.1 Pace in Obstacles**

Athletes may use any pace in the obstacles.

*At EC-recognized events, Training Division Competitors may not canter in the Obstacles. (-C960.2.8.)*

#### **965.2 Error of Course in an Obstacle:**

- 2.1 Athletes entering any part of an obstacle without first passing through the

- entry flags or failing to pass through the exit flags on leaving an obstacle without correcting the error will be eliminated.
- 2.2 The compulsory gates in an obstacle are “free” after an Athlete has passed through them in the correct direction and in the correct sequence. Athletes may, therefore, go through them again in any direction at any time (for example, Athletes must go through A in the correct direction before going through B. A is now “free” and they may go through it again in any direction as often as they like, and so on).
  - 2.3 Athletes who pass through a compulsory gate in the wrong sequence or direction before it becomes “free” and without correcting the error before passing through the Exit Flags, will be eliminated.
  - 2.4 In order to correct an error of course, the Athlete must return to and drive the compulsory gate he missed before continuing through the next compulsory gate in the correct sequence. For example, an Athlete drives through compulsory gates A and B and then goes through D (missing gate C). In order to correct this error of course, the Athlete must go back and drive through gate C before going on to gate D, etc. All gates are neutralized until he reaches this gate. Each Error corrected shall incur 20 penalties
  - 2.5 Passing through the exit gate of an Obstacle without driving all compulsory gates in the correct sequence will be penalized by Elimination.
  - 2.6 An Athlete is not considered to have passed through a Compulsory gate in an obstacle until the whole turnout has passed between the flags denoting the Compulsory gate.

### **965.3 Dismounting in the Obstacles**

- 3.1 Each time either or both Grooms put both feet on the ground in an obstacle, the Athlete will incur five penalties.
- 3.2 Once Grooms have dismounted they are not required to get back onto the carriage and need not follow the Athlete through any of the Compulsory Gates in the rest of the Obstacle. Grooms do not have to be on the Carriage when it leaves the obstacle. They must get back on the carriage immediately (between the finish line of each obstacle and the 30-meter sign) outside of the obstacle. Failure to do so will incur five penalties per incident.
- 3.3 Each time an Athlete dismounts in an obstacle he will incur 20 penalties He must be on the carriage when it leaves the Obstacle.
- 3.4 In all incidents (for example trace or reins or lead bar over part of an obstacle, etc.), the grooms must dismount and solve the problem (no climbing over Horses or pole). Failure to comply will incur 20 penalties.
- 3.5 An Athlete or Groom may only put one foot on any part of an obstacle without incurring penalties. Contravention of this Article will result in five penalties.
- 3.6 A Groom may assist the Athlete by leading a Horse through the obstacle by the bridle end of the reins. The Athlete will incur 25 penalties in total. See [C969](#) and [C945.3](#).
- 3.7 Groom(s) must be on the carriage when the Athlete enters each obstacle on the Marathon. Failure incurs 5 penalties.

### **965.4 Disconnecting**

Deliberately disconnecting one or more Horses and leading them through any part of the obstacle will be penalized by Elimination.

### **965.5 Elimination in an Obstacle**

The decision whether an Athlete is eliminated in an obstacle rests entirely with the Ground Jury.

## 965.6 Welfare of the Horse

- 7.6 It is the responsibility of the Athlete to stop immediately and put a Groom or Grooms down whenever a Horse has its leg over a Pole, Shaft, when a wheeler has a leg over the lead bar or the leader's trace, or when a Horse is down and remains down. Also, he must stop when instructed to make necessary repairs by a Member of the Ground Jury or Obstacle Observer. However a trace down or a pole strap disconnected needs no repair inside an obstacle. The time will continue to run.
- 7.7 Failure to stop and put the Groom down to correct the situation before leaving the obstacle will incur Elimination.
- 7.8 It is the responsibility of the Athlete to stop immediately and put a Groom or Grooms down whenever a Horse has a leg over a Trace. Also, he must stop when instructed to correct the situation by a Member of the Ground Jury or Obstacle Observer. Failure to stop and put the groom down to correct the situation before leaving the Obstacle will incur 30 penalties. The time will continue to run.

## 965.7 Timing

- 7.1 The Athlete will be timed from the moment when any part of the turnout crosses between the entry flags until any part of the turnout passes between the exit flags from the correct direction. Once the clock has stopped, no further penalties from that Obstacle can be incurred and the turnout must leave the Obstacle.

*At EC-recognized events other than Arena Trials, Obstacle elapsed time for Training division competitors shall not be provided nor shall time penalties be applied for the elapsed times in the Obstacles. The five-minute time limit shall apply (See 7.3 below). Only total Section times will be recorded and penalty points posted, in keeping with the intended objective for the division.*

- 7.2 omitted
- 7.3 The Time Limit for Athletes in obstacles is five minutes. If Athletes fail to complete the whole obstacle and pass the exit flags within the Time Limit, the Obstacle Observer is to blow two blasts on a whistle indicating to the Athlete that the Time Limit has been reached. The Athlete must then vacate the obstacle as quickly as possible (with assistance if necessary) and may not continue in the Competition.
- 7.4 The time taken for an Athlete to complete an Obstacle shall be recorded to hundredths of a second, either manually or electronically.
- 7.5 There is no rounding of time or conversion to penalty points for individual Obstacles.

## 965.8 Hold Ups

- 8.1 If an Athlete arrives at an obstacle while the previous Athlete is still negotiating the obstacle, or if the Obstacle is not ready to be driven, he is to be held at a point on the course approximately 50 m from the Entry Flags.
- 8.2 One of the Assistant Obstacle Observers is to stop the Athlete at that point and start his stopwatch. As soon as the previous Athlete is clear of the obstacle, and the Obstacle Observer approves a restart, the Assistant Obstacle Observer will restart the Athlete and inform him of the time he has been held. This should be in whole or half minutes.

*At EC-recognized events, competitors being held will be restarted only in whole-minute intervals.*

## 965.9 Obstacle video recording

Video recording at each Obstacle is recommended in all Events. Such video

recording is compulsory at CAI World Cup™ Qualifiers, CAIOs and [FEI] Championships.

## **ARTICLE C966 JUDGES**

### **966.1 Positions**

- 1.1 One member of the Ground Jury must be at the end of Section B to supervise the inspection of carriages, harness and Marathon Time Cards and when applicable to supervise the weighing of the carriages. An Athlete whose carriage is below the prescribed weight will be eliminated. (See [C969](#).)  
*At EC-recognized events, there are no minimum weights or widths. (See [C937](#).)*
- 1.2 The rest of the Jury will be positioned by the President of the Ground Jury.  
*At EC-recognized events, positioning and duties specified in 1.1 and 1.2 above shall be determined by the President of the Ground Jury.*
- 1.3 *For marathon competitions with more than 50 entries, a Ground Jury of at least three members is required.*
- 1.4 *Members of the Ground Jury at the end of the walk section or the end of Section B are not required to assist the veterinarian in pulse and respiration checks. Organizers should ensure sufficient volunteers are available to assist the veterinarians.*

## **ARTICLE C967 OFFICIALS**

### **967.1 Ground observers**

- 1.1 Ground Observers should be allocated positions around the course by the Technical Delegate from which they can observe the most critical compulsory turning flags.
- 1.2 Ground Observers must be given the starting order of Athletes together with copies of instructions and the Ground Observers Report and a Control Sheet.
- 1.3 Ground Observers must report all incidents for which an Athlete may be penalized, and any other information, to the Ground Jury or member of the Ground Jury periodically and at the end of their period of duty.
- 1.4 Ground Observers cannot eliminate or otherwise penalized Athletes. It is the responsibility of the Ground Jury to impose appropriate penalties.
- 1.5 After the competition, Ground observers must remain in the vicinity of the Secretary's Office until dismissed by the President of the Ground Jury.

### **967.2 Timekeepers**

- 2.1 Each Timekeeper will be provided with a chronometer with a "time of day" display and instructed in its use by the Technical Delegate or the Chief Timekeeper. The Technical Delegate or his assistant is responsible for the synchronization of the "time of day" on all chronometers issued to Officials.
- 2.2 The Timekeeper at the start of Section A must be issued with the starting time schedule and should ensure that Athletes have been given a "Marathon Time Card" (Green Card).
- 2.3 All other Timekeepers at the start and finish of each Section must be provided with the complete list of Athletes and a running order.
- 2.4 Timekeepers are required to record the start and finish times for their respective Sections and to enter them on the Athlete's "Marathon Time Card" and the "Section Timer Record".
- 2.5 Horses must start from the halt with the nose of the leading horse behind the

start line.

- 2.6 The finishing time will be taken as the nose of the leading horse crosses the finish line. The section is finished as the rear axle has passed the Finish Line.
- 2.7 After the competition, Timekeepers must remain in the vicinity of the Secretary's Office until dismissed by the President of the Ground Jury.

### **967.3 Obstacle observers**

- 3.1 There must be one obstacle observer at each Obstacle. Each obstacle observer must have at least two assistants. The obstacle observer must be given a whistle and two stopwatches and instructed in their use by the Technical Delegate or his assistant. They must record the exact time to hundredths of a second taken by each Athlete through the obstacle.  
*At EC-recognized events, the number of Obstacle Observers at each obstacle will be determined by and at the discretion of the Technical Delegate.*
- 3.2 Obstacle observers must be given a starting order listing all Athletes together with sufficient copies of Obstacle Reports and diagrams to record each Athlete's time and the sequence of the gates through the obstacle as driven.
- 3.3 In case of incorrect sequence, a drawing of the route must be recorded.
- 3.4 Obstacle observers must record and report all incidents to a member of the Ground Jury, as soon as possible after the incident occurred.
- 3.5 After the competition, obstacle observers must remain in the vicinity of the Secretary's Office until dismissed by the President of the Ground Jury.

## **ARTICLE C968 CLASSIFICATION**

### **968.1 Conversion of time to penalties**

- 1.1 The total time taken by the Athlete in the Obstacles will be recorded to hundredths of a second and penalties will be calculated to two (2) decimal places. Any time over the Time Allowed in each of the Sections will be added together and multiplied by 0.25. Any time under the Minimum Time in Sections A and B will be multiplied by 0.25. There shall be no rounding of times. The penalties for under Minimum Time; plus penalties for over Time Allowed and the total Obstacle times shall be added to any other driving penalties received to determine the final score for each Athlete in Marathon.
- 1.2 For Athletes who are Eliminated or Retire see -C911.
- 1.3 The Athlete with the lowest number of penalties will be the winner of the Competition.
- 1.4 In the event of an equality of penalties, the Athletes will be placed on equal rank.

## ARTICLE C969 SUMMARY OF PENALTIES IN MARATHON AND IN COMBINED MARATHON

969.1 Athletes are liable to the following penalties in Marathon:

DESCRIPTION	REFERENCE ARTICLE	PENALTIES
Athlete or Groom wearing shorts .	<a href="#">928.2</a>	10 penalties per person
No Protective Headgear or no body protector on Marathon . <i>See ADS modification.</i>	<a href="#">928.2</a>	Elimination and Yellow Warning Card
Finishing Section B with fewer Horses than required .	<a href="#">931</a>	Elimination
No breeching with a carriage with no brakes .	<a href="#">937</a>	Elimination
No breeching for Singles	<a href="#">940</a>	Elimination
Contravening the rules on advertising .	<a href="#">941</a>	Yellow Warning Card
Substitution of a Groom .	<a href="#">943.2</a>	Elimination
Groom handling reins, or using whip or brakes when carriage not stationary .	<a href="#">943.2.6</a>	20 penalties
Person tied to the carriage	<a href="#">943.2.7</a>	Elimination
Outside Assistance	<a href="#">945.2.2</a>	Elimination
Groom leading a Horse through an obstacle	<a href="#">965.3.6</a>	25 penalties
Incorrect pace	<a href="#">960.6.2</a> & <a href="#">964.4</a>	1 penalty for every 5 sec .
Dislodging a dislodgeable element	<a href="#">961.5.6</a>	2 penalties per occurrence
Preventing a dislodgeable element from being dislodged	<a href="#">961.5.6</a>	10 penalties
Motorized vehicles or bicycles in obstacles . First Incident Second Incident	<a href="#">962.3.5</a>	Yellow Warning Card
Carriages under weight at end of B or under width at start of B . <i>ADS exempt</i>	<a href="#">937</a> , <a href="#">966.1</a>	Elimination
Total time over Time Allowed in all Sections	<a href="#">963.5.1</a>	0 .25 penalties/sec .
Total time under Minimum Time in Sections A and B	<a href="#">963.5.2</a>	0 .25 penalties/sec .
Total time in obstacles	<a href="#">968.1.1</a>	0 .25 penalties/sec .
Athlete fails to stop when recalled	<a href="#">963.4.3</a>	Elimination
Not ready to Start Section A	<a href="#">963.4.2</a>	0 .25 penalties/sec .
Contravening the rule on the use of the whip	<a href="#">964.1</a>	20 penalties
Each deviation from Course after last obstacle or last 300m	<a href="#">964.3</a>	10 penalties
Required persons not on carriage passing through a compulsory turning flag, or the start and finish of each Section, each occasion .	<a href="#">964.5</a>	5 penalties
Grooms Dismounting while moving in Section B .	<a href="#">964.5</a>	5 penalties
Athlete Dismounting while moving in Section B .	<a href="#">964.5</a>	20 penalties
Finishing Section B with missing or disconnected Pole strap, trace or reins for each occurrence .	<a href="#">964.7</a>	10 penalties

DESCRIPTION	REFERENCE ARTICLE	PENALTIES
Stopping on course for reasons other than repairs	<a href="#">964.6</a>	1 penalty per commenced second
Failing to pass through compulsory turning flags and obstacles in correct sequence and direction	<a href="#">965.2</a>	Elimination
Finishing Section B with missing wheel .	<a href="#">964.7</a>	Elimination
Finishing Section B with broken or disconnected pole or shaft.	<a href="#">964.7</a>	Elimination
Failing to pass through entry flags of an Obstacle.	<a href="#">965.2</a>	Elimination
Groom(s) not on the carriage when crossing start of an obstacle	<a href="#">965.3.7</a>	5 penalties
Grooms not remounting on the carriage immediately outside of an obstacle (per incident)	<a href="#">965.3.2</a>	5 penalties
Failing to pass through exit flags of an obstacle within 5 minutes	<a href="#">965.7.3</a>	Elimination
For correcting each error of Course in an obstacle.	<a href="#">965.2</a>	20 penalties
Passing between exit flags before completing an Obstacle.	<a href="#">965.2</a>	Elimination
Groom(s) dismounting in an obstacle, each occasion.	<a href="#">965.3</a>	5 penalties
Athlete dismounting in an obstacle.	<a href="#">965.3</a>	20 penalties
Two feet on an Element of obstacle.	<a href="#">965.3</a>	5 penalties
Groom climbing over Horse back or down the pole in an obstacle	<a href="#">965.3</a>	20 penalties
Disconnecting and leading through an Obstacle.	<a href="#">965.4</a>	Elimination
Failing to stop for leg over pole, lead bar or shaft.	<a href="#">965.6</a>	Elimination
Failing to stop for leg over trace.	<a href="#">965.6</a>	30 penalties
Carriage overturning	<a href="#">964.7.4</a>	Elimination
Exceeding the Time Limit in obstacles (5 min.)	<a href="#">965.7.3</a>	Elimination
Horses unfit to continue in rest area	<a href="#">966.1</a>	Elimination
Exceeding the Time Limit in any Section	<a href="#">968.1.1</a>	Elimination
Combined Marathon - Knocking over/down any element of a marathon-type obstacle		3 penalties
Error of Course: Knocking down any part of an obstacle in advance of being driven the PJ will ring the bell and the obstacle rebuilt (clock stops)	<a href="#">975.3.4</a>	3 penalties & 10 seconds added to the time.

## CHAPTER 13 – CONES

### ARTICLE C970 GENERAL

The Cones Competition is to test the fitness, obedience and suppleness of the horses and the skill and competence of the Athletes.

### ARTICLE C971 COMPETITIONS

#### 971.1 The Fault Competition shall be used in Driving Events

- 1.1 The Fault Competition is conducted on the basis of penalties for obstacles knocked down and for exceeding the Time Allowed. The score from this round will always be used solely to decide the Final Classification in all Events.
- 1.2 There may be a Drive-off between all Athletes with zero penalties, or equality of penalties to determine the winner of Cones.

#### 971.2 The Time Competition

The Time Competition is conducted on the basis of the time in seconds taken by Athletes to complete the course, with any penalties for faults converted to penalty seconds. Time Competitions are only to be used to determine the placings in Cones.

#### 971.3 Competition in Two Phases

The result of the first section may solely be used for the final results of the Combined Driving Event.

#### 971.4 Competition with a Winning Round

This competition is run over one round according to penalties and time which will count for the final classification in the Driving Event, and a winning round to determine the placings in Cones. (*See also Art. C980*).

### ARTICLE C972 THE COURSE

#### 972.1 Building and Measuring the Course

- 1.1 The Course Designer is responsible, under the supervision of the Technical Delegate, for laying out, marking and measuring the course and building the obstacles. The Course Designer must indicate with a dotted line on the course plan how the length of the Course was measured. The President of the Ground Jury must ensure that the length of the Course was measured accurately.
- 1.2 The arena should be not less than 5000m<sup>2</sup> with a minimum width of 40m or an equivalent area. Should this not be possible the number of obstacles must be reduced accordingly unless an exception is granted by the Technical Delegate. A size-reduced arena for VSE classes may be offered. It should be not less than 60m x 100m or equivalent area, or the number of obstacles must be reduced accordingly
- 1.3 The starting and finishing lines may not be more than 40m nor less than 20m from the first and last obstacles respectively. For VSE's in a size-reduced arena, the starting and finish lines may not be more than 30m nor less than 15m from the first and last obstacles respectively.
- 1.4 The number of obstacles may not exceed 20 (except Article C979.3), and for [FEI] Children, the number may not exceed 15.
- 1.5 The length of the (CONES) course must be between 500m and 800m, for Children it may be shorter. For VSE's in a size-reduced arena, the length of course must be between 375m and 600m.
- 1.6 Courses must be laid out so that Athletes have a chance to maintain a



reasonably fast pace throughout the major part of the course. Certain obstacles, and combinations of obstacles, such as open and closed multiples, will inevitably slow down the pace, but such a layout should be limited to a small proportion of the whole course.

- 1.7 All obstacles should be visible from the Judges' boxes.
- 1.8 The President of the Ground Jury must walk the course to inspect it before the start of the Competition. The course is the track which the driving Athlete must follow when competing, from passing the start in the correct direction up to the finish. The length must be measured accurately to the nearest meter taking account, particularly on the turns, the normal line to be followed by the Horse(s). This normal line must pass through the middle of the obstacles. If there is an alternative obstacle, the official distance has to be measured by the longest route.

## ARTICLE C973 OBSTACLES

### 973.1 Cones

- 1.1 The cones forming an obstacle must be at least 30 cm high and made of indestructible plastic material. A weighted ball must be placed in the hollow on top of the cone, so that it falls down only if the cone is touched.
- 1.2 All obstacles consisting of a single pair or double pair (oxer) of cones will constitute a single obstacle.
- 1.3 The obstacle includes cones, red and white markers, numbers and letters.
- 1.4 The position of one of the pair of cones must be marked on the ground so that a constant position of the obstacle is maintained throughout the competition. Where practicable, a line will also be drawn to ensure that the other cone is maintained at the correct angle.
- 1.5 Obstacles that entail reining back are not permitted.
- 1.6 An oxe will be composed of two pairs of cones in a straight line. The distance between the first set of cones and the second set will be between 1.5 and 3 meters, at the option of the Course Designer. The maximum penalties per oxe is three penalties, for hitting one to four balls. The first set of cones will have the number of the obstacle, the second set will only be marked with red and white flags.
  - A maximum of five oxers are allowed in a Cones course.

*1.7 At EC-recognized events, minimum clearance between pairs of cones shall be:*

DIVISION	HORSES AND PONIES	VSE
Training division	35 cm + track width *	30 cm + track width *
Preliminary division	30 cm + track width *	25 cm + track width *
Intermediate division	25 cm + track width *	20 cm + track width *
Intermediate II division	20 cm + track width*	15 cm + track width*

\* Increase settings by 10 cm for tandems, unicorns and four-in-hands.

*1.8 At EC-recognized events, at the Organizer's option, Cones clearances may be based on Standardized vehicle track widths for any or all divisions or the Organizer may restrict vehicles to one or more categories. If exercising these options, the Organizer must publish this in advance in the Prize List, identifying that "Standardized Cones/Obstacles settings shall be used in the following specified classes or divisions."*

*1.9 At EC-recognized events electing to use Standardized Cones settings, the*

following table shall apply:

VEHICLE	VEHICLE TRACK WIDTH (CM)	STANDARDIZED CONES SETTING (CM)		
		TRAINING	PRELIMINARY	INTERMEDIATE
<b>MARATHON VEHICLES</b>				
Ponies/Horses, single/pair	125 – 130	160	155	150
Ponies/Horses, unicorn/four-in-hand		170	165	160
<b>PRESENTATION VEHICLES</b>				
Ponies, single/pair	138 – 145	175	170	165
Ponies, unicorn/four-in-hand		185	180	175
Horses, single	138 – 145	175	170	165
Horses, tandem	138 – 145	185	180	175
Horses, pair	148 – 155	185	180	175
Horses, unicorn/four-in-hand	158 – 165	205	200	195
<b>VSE VEHICLES</b>				
Size A	98 – 106	135*	130*	125 *
Size B	107 – 115	145*	140*	135 *
<b>ALL OTHER VEHICLES</b>				
To be measured on an individual basis		Add clearances as shown in Table <a href="#">C-973.1.7</a>		
* Increase these settings by 10 cm for tandems, unicorns & four-in-hands				
Note: For VSE Advanced division cones settings in Driving Trials and Arena Trials, see <a href="#">C-973.1.7</a>				

### 973.2 Multiple Obstacles

- 3.2 Multiple Obstacles must conform to the design principles, see FEI Annexes 3 and 4.
- 3.3 Variations or new designs must be pre-approved by the FEI Driving Committee and included in the Event Schedule.
- 3.4 A Multiple Obstacle may be constructed of markers or horizontal rails, elevated to a minimum of 40 cm and maximum of 60 cm in height.
- 3.5 Each group of cones or elements must be clearly separated and associated with one of the sections of the multiple.
- 3.6 A Multiple Obstacle, other than a “Serpentine”, “Zig-Zag”, a “Double Box” a “Double U” or a “Wave” must not consist of more than three pairs of cones or dislodgeable elements.
- 3.7 Other than Serpentes, Zig-Zags, Double Boxes, Waves and Double Us, a Multiple Obstacle may not be longer than 30m measured along the centre line through the obstacle.
- 3.8 There may not be more than three (3) Multiple Obstacles in any course.
- 3.9 In Multiple Obstacles Athletes can only incur a maximum of 6 penalties in a Double (A & B), 9 penalties in a Triple (A, B & C) and 12 penalties in a Serpentine, Zig-zag, Double Box, Wave or Double U (A, B, C & D) per attempt, plus any penalties for a rebuild as well as penalties for Disobedience.
- 3.10 Multiple Obstacles may not be used in a Drive-Off. (See [C977](#) and [C981](#)).

### 973.3 Serpentes, Zig-Zags, Double Boxes and Double U and Wave

- 3.1 A Serpentine consists of four (4) cones in a straight line facing in alternate directions lettered A, B, C, D (see Annexes).
- 3.2 A Zig-zag consists of not more than four (4) pairs of cones, with alternate left and right cones in a straight line (refer to the website). All centerline cones must be placed in a straight line, either at the front, middle or rear of the cone.
- 3.3 A Double Box and a Double U and a Wave are illustrated in the Annexes.

#### **973.4 Water and Bridges**

- 4.1 Where Water Obstacles and Bridge Obstacles are included in the course, prior notification must be given in the Schedule for the event.
- 4.2 Water Obstacles must be at least 3 m wide, with a depth between 20 and 40 cm and sloping sides. There must be a pair of cones at the entrance (flag lettered A) and exit (flag lettered B) with the cones 2.0 m apart. Water depth for VSE classes may not exceed 20 cm.
- 4.3 Knocking down a ball or balls on either A or B will be penalized as 3 penalties for each pair of cones.
- 4.4 Wooden bridges, or bridges of similar suitable construction approved by the Technical Delegate, with fan shaped wings at the entrance, with the bridge surface not more than 35 cm (note that this is a change from the 20 cm currently in EC rules) above the ground with a usable width of three metres and a maximum length of ten metres are permitted, and boarded or rail sides are essential. The Technical Delegate may grant an exception if the bridge is of a permanent solid construction with strong side rails. There must be a pair of cones at the entrance (flag lettered A) and exit (flag lettered B) with the cones at least 2.0m apart.
- 4.5 *At EC-recognized events, water obstacles may not be used as part of a Training or Preliminary Division course. Obstacles with bridges may be used in Training Division, when available at the athlete's option.*

#### **973.5 Markers**

- 5.1 Each obstacle is defined by a pair of markers: a red marker on the right hand side and a white marker on the left hand side as Athletes approach the obstacle. They are placed not more than 15 cm outside the elements which form the single and multiple obstacles.
  - 5.2 The whole turnout must pass between these markers. Failure is considered as Disobedience. (See [C975.7.3](#) and [C960.6](#)).
  - 5.3 Decorations and obstructions must be placed on the course before the official course walk. No penalty is incurred if they are touched, displaced or knocked over.
  - 5.4 All obstacles in the course must be numbered in the sequence in which they are to be driven. The number of each obstacle must be indicated on a board placed at the entrance to each single and Multiple Obstacle.
  - 5.5 Each distinct section of a closed Multiple Obstacle (Ls, Us and Boxes) must be clearly marked in different colors (see Annexes). The whole turnout must pass between these markers in the correct alphabetical order.
- The red and white markers and the numbered and lettered boards may be combined, so that the numbers and letters appear on the same posts as the red and white markers, or they may be on separate boards or discs. If possible the numbers of the obstacles should be placed so that Athletes can see them as they leave the previous obstacle.

#### **973.6 Plan of the Course**

- 6.1 At least two hours before the start of the Competition for each class in the

Event, a plan of the course, with the dotted line how the length was measured, signed off by the Course Designer and the President of the Ground Jury must be given to the Athletes and be posted in the Collecting Ring showing the length, speed in meters per minute and the Time Allowed for that class. Should the timing be adjusted by the Ground Jury, this will be announced by the Commentator.

- 6.2 *At EC-recognized events, a plan for the Cones need not be supplied to each Competitor provided one is posted on the Official Notice Board once the Course is approved by the President of the Jury and prior to the course being open for inspection.*

### **973.7 Inspection of the Course**

- 7.1 The course must be open for inspection at least one hour and forty-five minutes before the start of the competition. A 15-minute window must be observed between the end of the inspection and the first start. Only Chefs d'Equipe (when applicable), Athletes and one accompanying person per Athlete at a time are allowed to inspect the course on foot and they must be correctly and smartly dressed. Athletes and their accompanying person, and Chefs d'Equipe, are not permitted to use measuring wheels when inspecting the course. At an Event, a warning will be issued for the first offence and a Yellow Warning Card from the President of Jury for subsequent offences.  
*At EC-recognized events, Athletes with limited mobility will be permitted to drive themselves through the Cones course at a walking pace in golf carts or similar vehicles.*  
*At EC-recognized events all grooms are allowed to inspect the course.*
- 7.2 Only the Course Designer and his staff may alter or work on any part of the course. If any Athlete, or any person associated with him alters the course in any way, the Athlete will be disqualified.

## ARTICLE C974 CONES COMPETITION SUMMARY

### 974.1 Single Obstacles and Open Multiple obstacles

DIVISION CLASS		SPEED (M/MIN)*	CONES WIDTH (CM) *	SERPENTINE	ZIGZAG	WAVE	DISTANCE BETWEEN OBSTACLES
HORSE	Four-in-hand	240	185**	10-12	11-13	10-12	15
	Pair	250	170**	6-8	10-12	8-10	12
	Single		160**				
	Para-Driving	230					
PONY	Four-in-hand	240	160**	8-10	9-11	8-10	12
	Pair	250	160** (Children 20 cm clearance)	6-8			
	Single	260					
	Children	220					
	Para-Driving	230					
VSE	Pair or Multiple	*		9	9	8-10	12
	Single			6	8		9

\* At **EC-recognized** events, see [C973.1.7](#) for obstacle clearances and [C975.9.4](#) for speeds.

\*\* In **EC-recognized** Cones competitions, for divisions other than Intermediate II and Advanced the minimum clearance for obstacle cone pairs is based on each competitor's vehicle track width. Alternately, the Organizer may choose to use Standardized Cones settings, or a modified combination thereof, for any or all classes, as illustrated in the table in [C973.1.9](#), provided competitors are advised in advance of the event in the Prize List.. The width of closed multiples should be greater than minimum.

- 1.1 Measurements for Closed Multiple obstacles, see Annexes.
- 1.2 Cones with reduced width: The width of up to five single obstacles may be reduced by 5 cm for Pairs and Four-in-Hand classes, and up to 10 single obstacles may be reduced by 5cm for Single classes. Such obstacles will be marked differently (color of the cones).
- 1.3 Alternative options: A maximum of two (2) single obstacles may offer an alternative single option (see [FEI Annex 5](#)).
- 1.4 In exceptional circumstances and in the interests of safety, the Ground Jury in consultation with the Course Designer and the Technical Delegate, may reduce the speed.
- 1.5 Drive-offs and Winning-Round: the obstacle width may be reduced up to 10 cm at the discretion of the Ground Jury in conjunction with the Course Designer and the Technical Delegate.

## ARTICLE C975 JUDGING CONES COMPETITION

### 975.1 Starting the Competition

- 1.1 The Technical Delegate will report to the President of the Ground Jury as soon as the course is ready. The President of the Ground Jury will then authorize the start of the competition.
- 1.2 After the bell has rung, the Athlete has 45 seconds to cross the start line.

### 975.2 Penalties

- 2.1 If Athletes have entered the Arena but fail to start by passing through the

- start line within 45 seconds of the starting signal the timing will start.
- 2.2 If an Athlete fails to enter the Arena when the Course is ready, the President of Jury will ring the bell to signify the Start for that Athlete. If the Athlete has not entered the arena within 45 seconds of the first bell, the bell will be rung again and that Athlete is then Eliminated.
  - 2.3 Athletes starting and passing through an obstacle before the starting signal will be penalized 10 penalty points and must restart.
  - 2.4 The start and finish lines are neutralized for passing through from the moment the Athlete has passed through the start line until he has passed through the last obstacle.
  - 2.5 Knocking down one or both balls of a single obstacle and knocking down a ball or an element of a Multiple Obstacle incurs three (3) penalties in each case.
  - 2.6 Knocking down a ball or balls on either A or B on a Water or Bridge Obstacle will incur three (3) penalties for each pair of cones.
  - 2.7 Grooms must be seated in their proper places between the start and finish lines. They are not allowed to indicate the course or to speak unless they are dismounted. For penalties, see [C981](#).  
*In EC-recognized competitions, if carriage does not have a safe groom seat, judge may grant permission for groom(s) to stand with no penalty.*
  - 2.8 After the last obstacle the Athlete must pass through the finish line with the red flag on the right and the white flag on the left.
  - 2.9 An Athlete may pass between the elements of an open multiple obstacle while driving between obstacles without incurring a penalty. If, in this case, a part of the obstacle is knocked down see [C981](#).
  - 2.10 Carriage overturning is elimination.

### 975.3 Error of Course

- 3.1 An Athlete is considered to have passed through a gate in an Obstacle when the whole turnout has passed between the Markers.
- 3.2 If an Athlete attempts to pass through an obstacle in the wrong sequence or direction, then the President of Jury must wait until the whole turnout has passed completely through the wrong obstacle before ringing the bell. The Athlete is then Eliminated.
- 3.3 If an Athlete knocks down or dislodges any part of an obstacle which has already been driven, he will incur three (3) penalties.
- 3.4 If any part of an obstacle in advance of the one being driven, is dislodged or knocked down, the President of the Ground Jury will ring the bell and stop the clock for the obstacle to be re-built.  
The Athlete will incur three (3) penalties and 10 seconds will be added to his time. The bell will be rung to indicate to the Athlete that the course is ready and the clock will re-start when the Athlete reaches the next Obstacle on course to continue his round.
- 3.5 If the President of the Jury sounds the whistle/bell while the Athlete is on the course, the Athlete must halt immediately. If the Athlete does not halt, the President of Jury will blow the whistle/ bell a second time. If this Athlete continues without stopping, he is eliminated. The Groom may advise the Athlete that the whistle/bell has sounded.
- 3.6 If the Jury is in doubt whether an obstacle has been properly driven, the Athlete must be allowed to finish the course. The Jury can then reach a decision.

*In EC-recognized Cones competitions, the person judging Cones shall*

*perform the duties in 3.2 through 3.6 above.*

#### **975.4 Obstacle Rebuild**

- 4.1 If the Athlete knocks down any part of an Obstacle in the process of disobedience or refusal, the bell will be rung and clock stopped for the obstacle to be rebuilt, and ten seconds will be added to the Athlete's time along with any penalties for Disobedience (but not for the elements knocked down at the time of Disobedience).
- 4.2 When the obstacle is rebuilt the bell is rung again and the Athlete must then retake the complete obstacle and continue his round. The clock will restart when the Athlete reaches the re-built obstacle. Penalty for starting before the bell is Elimination.
- 4.3 If an Athlete knocks down any part of a Multiple Obstacle in advance of the element he is driving, or if he breaks out of the Multiple Obstacle and knocks down an element, then the bell will be rung, the clock stopped while the obstacle is rebuilt and 10 seconds added to the total time taken. He will be penalized for Disobedience but not for the elements knocked down at the time of the Disobedience.

#### **975.5 Broken Harness**

If at any time after he has started, an Athlete has a disconnected pole, shaft, rein, trace, pole strap or chains, or should a horse have a leg over the pole, trace, shaft or leader bars the President of the Jury must ring the bell and stop the clock. The Athlete must put a Groom(s) down to correct the problem and will be penalized for a Groom dismounting. After the situation has been corrected and the Groom has remounted the President of the Jury will ring the bell and restart the clock.

#### **975.6 Athletes and Grooms Dismounting**

- 6.1 Each time an Athlete dismounts he will incur 20 penalties.
- 6.2 Athletes will incur penalties each time one or both Grooms dismount: five (5) penalties on the first occasion, 10 penalties on the second occasion. On the third occasion the Athlete is Eliminated.
- 6.3 The Grooms must be on the carriage when going through each Obstacle. For a Groom(s) dismounting to assist through an obstacle by leading the horse by the bridle ends of the reins while the horse is still attached to the carriage see penalties for leading and dismounting in [C98I](#). The Groom(s) must be on the carriage before the next Obstacle.

#### **975.7 Disobedience**

- 7.1 It is considered to be a Disobedience when:
  - a. The Athlete attempts to pass through an obstacle and his Horse shies away from the obstacle at the last moment without hitting any part of the obstacle.
  - b. The Horses run away, or, in the opinion of the President of the Jury, the Athlete has lost effective control.
  - c. The whole turnout comes to a complete halt with or without stepping back anywhere on the course, in front of or in an obstacle, or a Multiple obstacle, with or without knocking down any element.
  - d. Not passing through an obstacle with the whole turnout, running out of a Multiple, circling within a Multiple or reining back by the Athlete between start and finish line.
- 7.2 A Disobedience will incur five (5) penalties for the first, 10 penalties for the second and elimination for the third instance. Penalties for Disobedience are cumulative wherever they may occur on the course.

- 7.3 If there is Disobedience in a single obstacle, i.e. the whole turnout does not pass through the markers, the Athlete has to retake the obstacle. The bell will only be rung if part of the obstacle is knocked down (See [C975.4](#)).
- 7.4 If there is a Disobedience in a Multiple obstacle without knocking down any element the Athlete must continue his drive and is penalized for disobedience (see above).
- 7.5 In the case when a Disobedience is connected with knocking down an element (for example, a run-out at C and dislodging the ball) the Judge rings the bell, the course is interrupted, the time is stopped and the obstacle rebuilt. The President of the Ground Jury rings the bell again, the Athlete has to restart at the letter A of the Multiple obstacle and the time starts when the Horse's nose passes gate A. For the re-building, 10 seconds are added once.
- 7.6 If an Athlete has a Disobedience at any obstacle and knocks down any part of that obstacle he will only incur penalties for the Disobedience and 10 seconds will be added for the rebuilding.

#### 975.8 Resistance

A Horse is considered to offer resistance if, at any time and for whatever reason it refuses to go forward (with or without moving back), turns around, rears. This will be penalized the same as Disobedience (see [-C975.7](#)).

#### 975.9 Timing

- 9.1 Each Athlete will be timed by stopwatch or by an electronic timing device, from the moment the nose of the leading horse crosses the Start Line until the nose of the leading Horse crosses the Finish Line, but penalties are incurred until the whole turnout has passed the finish line.  
*At EC-recognized events without electronic scoring, penalties for exceeding the time allowed may be calculated at 0.5 penalties per commenced second.*
- 9.2 Electronic timing must be used at Championships and CAIOs. Whenever possible a digital display unit should be visible for the Athletes.
- 9.3 Times must be recorded to hundredths of a second.
- 9.4 The Time Limit is twice the Time Allowed. Exceeding the Time Limit will incur elimination.
- 9.5 The Time Allowed is calculated using the following speeds in metres per minute (except for [C978](#) and for Children and for Para-Driving):

CLASS	SINGLE	PAIR	FOUR-IN-HAND
HORSES	250	250	240
PONIES	260	250	240

#### *Speeds at EC-recognized events:*

DIVISION		SINGLE, PAIR	TANDEM, UNICORN, FOUR-IN-HAND
Training	VSE	160 mpm	150 mpm
	Horse/Pony	180 mpm	170 mpm
Preliminary	VSE	180 mpm	170 mpm
	Horse/Pony	200 mpm	190 mpm
Intermediate	VSE	190 mpm	180 mpm
	Horse/Pony	220 mpm	210 mpm



Intermediate II	SINGLE	PAIR	TANDEM	UNICORN, FOUR-IN- HAND
Horse	250 mpm	250 mpm	240 mpm	240 mpm
Pony	260 mpm	250 mpm	240 mpm	240 mpm
VSE	200 mpm	200 mpm	190 mpm	190 mpm

9.6 The Penalty for exceeding the time allowed: any time over the time allowed in hundredths of a second, multiplied by 0.5. Penalties will be calculated to two decimal places.

**975.10 Incorrect pace**

*At EC-recognized events, Training Division Competitors may not canter in Cones Competition. Should one or more horses break into a canter, the Competitor will incur one penalty for each five seconds.*

**ARTICLE C976 FAULT COMPETITION**

**976.1 Definition:**

The Fault Competition is a Competition run with penalties and a time allowed.

**976.2 Classification:**

According to penalties and time. If allowed in the Schedule, there may be a Drive-Off in case of equality of penalties for the first place.

**ARTICLE C977 DRIVE-OFF**

**977.1 Definition**

A Drive-Off can only be organized in a Fault Competition, solely to define the classification of Cones Competition.

**977.2 Classification**

- 2.1 In the event of equality of penalties for first place, a Drive-off as time Competition may take place according to the provisions of the Schedule, either over the same course or over a shortened course (maximum 50% shorter).
- 2.2 The width between the cones may be reduced by up to a maximum 10 cm. at the discretion of the Ground Jury in conjunction with the Technical Delegate and Course Designer.
- 2.3 If no provision is made for a Drive-off in the Schedule, the Athletes with equality of penalties for any place are placed in accordance with the time taken to complete the first round. In case of equality of penalties and time, the Athletes concerned will be given equal placing.

**977.3 Multiple obstacles**

Multiple obstacles are not permitted in a Drive-Off.

**977.4 Starting order**

The starting order for a Drive-Off will be the same as in the initial round.

**ARTICLE C978 TIME COMPETITION**

**978.1 Definition**

In a Time Competition, all penalties (knock-downs, exceeding time, disobedience, etc.) are converted to penalty seconds.

**978.2 Obstacles**

The Rules concerning the number, type and dimensions of obstacles and the length of the Course must be the same as for a Fault Competition.

**978.3 Speed**

CLASS	SINGLE	PAIR	FOUR-IN-HAND
HORSES	250 mpm	250 mpm	240 mpm
PONIES	260 mpm	250 mpm	240 mpm

*Speeds at EC-recognized events:*

DIVISION		SINGLE, PAIR	TANDEM, UNICORN, FOUR-IN- HAND
Training	VSE	160 mpm	150 mpm
	Horse/Pony	180 mpm	170 mpm
Preliminary	VSE	180 mpm	170 mpm
	Horse/Pony	200 mpm	190 mpm
Intermediate	VSE	190 mpm	180 mpm
	Horse/Pony	220 mpm	210 mpm

Intermediate II	SINGLE	PAIR	TANDEM	UNICORN, FOUR-IN- HAND
Horse	250 mpm	250 mpm	240 mpm	240 mpm
Pony	260 mpm	250 mpm	240 mpm	240 mpm
VSE	200 mpm	200 mpm	190 mpm	190 mpm

#### 978.4 Classification

- 4.1 Classification will be decided by adding any penalty seconds to the time taken by the Athletes to complete the course.
- 4.2 In the case of equality for first place, the result may be decided either by the lowest number of penalty seconds incurred, or by a Drive-off, according to the provisions of the Schedule, either over the same course or over a shortened course.

### ARTICLE C979 COMPETITION IN TWO PHASES

#### 979.1 Description

- 1.1 This Competition is comprised of two phases run without interruption, each at an identical or different speed, the Finishing Line for the First Section being the Start Line for the Second Section.
- 1.2 A Competition in Two phases, run under the following Rules, may be used in all Cones Competitions.

#### 979.2 Competition Conditions

- 2.1 The first phase is run according to the Rules for a Fault Competition with a time allowed and the second Section is run according to the Rules for a Time Competition.
- 2.2 Penalties for both phases are listed under [C981](#).

#### 979.3 Obstacles

- 3.1 The first phase is a course of 14 to 16 obstacles with a maximum of two multiple obstacles. The second phase takes place over 7 to 9 obstacles (not to exceed 23 obstacles in total). Multiple obstacles may not be used in the second phase.
- 3.2 Width of obstacles: See [C974](#).

#### 979.4 Penalties

- 4.1 Athletes incurring penalties in the first Section are halted by ringing the

bell after they have passed the last obstacle or when the time allowed of the first phase has been exceeded after crossing the finishing line of the first phase. They must stop after crossing the first finishing line once the bell is rung.

4.2 Athletes not penalized in the first phase and not over the time allowed continue the course which finishes after crossing the second finishing line.

4.3 The second phase is run as a Time Competition.

#### **979.5 Classification**

- 5.1 Athletes are placed as follows: Athletes who competed in the second phase: Total time in the second phase to include added penalties converted into seconds;
- 5.2 Followed by the Athletes who competed in the first phase only: according to penalties and time in the first phase.
- 5.3 In the event of equality for first place, a Drive-off against the clock with six obstacles of the first and/or of the second phase may be held according to the conditions of the Schedule.
- 5.4 Athletes stopped after the first phase may only be placed after Athletes who have taken part in both phases.

### **ARTICLE C980 COMPETITION WITH A WINNING ROUND**

#### **980.1 Description**

This Competition consists of two parts with different valuations. The first part may be used for all Combined Competitions.

#### **980.2 Competition Conditions**

The first part is run according to the Rules for a Fault Competition with a Time Allowed and the second part is run according to the rules of a Time Competition.

#### **980.3 Obstacles**

- 3.1 The first part is a normal Course as laid down in the Rules.
- 3.2 The second part may be shorter but not by more than 50% shorter.
- 3.3 The Course for the second part (Winning Round) may be built at another time (or day) and another place and may be of a complete new design.
- 3.4 The Winning Round is not considered to be a Drive-Off.

#### **980.4 Athletes**

- 4.1 The number of the Athletes competing in the Winning Round is laid down in the Schedule.
- 4.2 The starting order in the Winning Round is the same as in the initial round.

#### **980.5 Penalties**

- 5.1 Option 1: The Athletes carry their penalties of the initial round as penalty seconds forward to the Winning Round.
- 5.2 Option 2: The Athletes start the Winning Round from scratch.

#### **980.6 Classification**

- 6.1 Option 1: The Athletes are placed according to their Total Time. This is the driven time plus penalty seconds for dislodgeable elements etc. and exceeding time in the Winning Round.  
Actual penalties from the initial round converted into penalty seconds will be added afterwards to the result of the Winning Round and all together form the Total Time.
- 6.2 Option 2: The Athletes are placed according to their driven time plus penalty seconds for dislodgeable elements etc. and exceeding time in the

Winning Round.

6.3 In case of a tie, equal placings are awarded.

## ARTICLE C981 SUMMARY OF PENALTIES IN CONES

Athletes are liable for the following penalties:

DESCRIPTION	REF. ART.	FAULT COMPETITION	TIME COMPETITION
Athlete or groom entering arena without securely fastened protective headgear .	<a href="#">928</a>	Elimination	
Athlete entering arena without hat, gloves or apron <i>See exception.</i>	<a href="#">928.1.5</a>	5 penalties	5 seconds
Groom entering arena without jacket, hat or gloves	<a href="#">928.1.3</a>	5 penalties	5 seconds
Driving without a whip in the competition	<a href="#">928.4</a>	5 penalties	5 seconds
Dropping or putting down the whip	<a href="#">928.4</a>	5 penalties	5 seconds
No breeching with a carriage with no brakes	<a href="#">937.1.1</a>	Elimination	
No breeching in Singles	<a href="#">937.1.1</a> <a href="#">940.1.13</a>	Elimination	
If a Groom handles the reins, brake or uses the whip before the Athlete has crossed the finish line	<a href="#">943.2.6</a>	20 penalties	20 seconds
Person tied to the carriage	<a href="#">943.2.7</a>	Elimination	
Illegal outside assistance	<a href="#">945.2</a>	Elimination	
Failing to start within 45 seconds of bell ring	<a href="#">975.1.2</a> <a href="#">975.2.1</a>	Timing starts	
Starting and passing through an obstacle before the bell is rung	<a href="#">975.2.3</a>	10 penalties and restart	10 seconds and restart
Failing to pass through start or finish lines	<a href="#">975.2</a>	Elimination	
For knocking down one or two balls in the same single obstacle	<a href="#">975.2.5</a>	3 penalties	3 seconds
For knocking down an element of a Multiple obstacle	<a href="#">975.2</a>	3 penalties	3 seconds
Grooms standing between the start and finish <i>See EC exception for waiving this penalty</i>	<a href="#">975.2.7</a>	5 penalties	5 seconds
For knocking down any part of an obstacle after it has already been driven	<a href="#">975.3.3</a>	3 penalties	3 seconds
Carriage overturning	<a href="#">975.2.10</a>	Elimination	
If any part of an obstacle in advance of the one being driven is knocked down, the bell will be rung for the obstacle to be rebuilt	<a href="#">975.3.4</a>	3 penalties and add 10 seconds	3 seconds and add 10 seconds
Taking an obstacle out of sequence	<a href="#">975.3.2</a>	Elimination	
Failure to halt after the bell is rung a second time	<a href="#">975.3.5</a>	Elimination	
For causing an obstacle, or part of a multiple to be rebuilt	<a href="#">975.4.1</a>	3 penalties and add 10 seconds	3 seconds and add 10 seconds
Starting before the bell after an obstacle is rebuilt	<a href="#">975.4.2</a>	Elimination	
Athlete dismounting	<a href="#">975.6.1</a>	20 penalties	20 seconds

Groom(s) dismounting: First incident Second incident Third incident	<a href="#">975.6.2</a>	5 penalties 10 penalties Elimination	5 seconds 10 seconds Elimination
Groom leading a Horse through an obstacle	<a href="#">975.6.3</a>	25 penalties	25 seconds
Disobedience: First incident Second incident Third incident	<a href="#">975.7.2</a>	5 penalties 10 penalties Elimination	Elimination
For exceeding the Time Allowed .	<a href="#">975.9.6</a>	Exceeded time multiplied by 0 .5	
Exceeding the Time Limit .	<a href="#">975.9.4</a>	Elimination	

## CHAPTER 14 OFFICIALS

*EC criteria for acceptance and promotion of licensed officials can be found in the Licensed Officials section (Part 6, Chapters 1 and 2) of this Rulebook. Job descriptions of various competition personnel can be found in Part 6, Chapter 3 (Non-Licensed Competition Personnel) section.*

*Refer to table Appendix 1-A – Event Summary Table for the required officials for various events.*

### ARTICLE C984 CONFLICT OF INTEREST

See Article C103

984.1 FEI Officials may not officiate at FEI Events and also compete in FEI Events in the same classes on the same continent within the same calendar year.

984.2 No person may be an official at an event if his duties will involve a conflict of interest.

984.3 The following persons may not be members of a Ground Jury or an Appeal Committee or Officials at an Event:

3.1 Athletes and Owners of Horses taking part in the Event:

3.2 Chefs d'équipe, team Officials, regular trainers, employers and employees of Athletes. Note: regular trainers means training a Horse/ Athlete for more than three days in the six month period before an Event, or any training during a period of three months before an Event.

3.3 Close relatives of Owners, Athletes, Chefs d'équipe or team Officials.

3.4 Persons having a financial or personal interest in a Horse or Athlete taking part in a Competition.

3.5 Person acting as Chef d'Equipe of national teams in the same class in the current year.

984.4 *At EC-recognized events, the Manager/Organizer of an event, members of the Manager's/ Organizer's family or household, the Technical Delegate, Course Designer or a member of the Appeals Committee (if one exists) may not serve on the Ground Jury.*

*At EC-recognized events, the training period above is 30 days before an event.*

## ARTICLE C986 JUDGES and ARTICLE C987 COMPOSITION OF GROUND JURY

See Table Appendix 1-A – Event Summary Table

### 987.2 The Duties of the Ground Jury

- 2.1 The Duties and Responsibilities of the Ground Jury are laid down in the [FEI] General Regulations.  
Each Member of the Ground Jury has the right and the duty to Eliminate or Disqualify any Horse which, in his opinion, is lame or unable to continue the Competition in accordance with [C903](#).
- 2.2 The President of the Ground Jury is responsible for the conduct and control of the entire Event, in conjunction with the Technical Delegate.
- 2.3 The President of the Ground Jury will have overall control of the Duties and Responsibilities of the Ground Jury throughout the Event.
- 2.4 All the members of the Ground Jury will judge Driven Dressage. In principle the Ground Jury should not judge more than 45 Driven Dressage Tests in a day; however this number may be increased in exceptional circumstances, at the sole discretion of the President of the Ground Jury.  
*A member of the Ground Jury, the event TD, or another EC-licensed Combined Driving Judge or TD may be assigned to judge Cones when Driven Dressage and Cones competitions are run concurrently.*
- 2.5 The President of the Ground Jury is responsible for the control and publication of the results of the Competitions and of the Event.  
*At EC-recognized events (more specifically, and in addition to those listed in 2.1 through 2.6 above), the period of jurisdiction of the Ground Jury extends from one hour before the start of the event until one half hour after the announcement of the final results of the competition for which the Ground Jury has been appointed. If an objection is made during the period of jurisdiction, the Ground Jury remains responsible until the objection is settled. (See Art. C991.)*
3. The Duties of the Ground Jury
- 3.1 The Duties and Responsibilities of the Ground Jury are laid down in the General Regulations. At Canadian events (Training, Preliminary, Intermediate, Advanced) are governed only by these Equestrian Canada Rules. Variations for these divisions are identified within the rules by italics type and are summarized in Combined Driving Appendices, A, B and/or E. For Canadian events, see Part Six, Chapter 1 for duties and responsibilities pertaining to licensed officials.
- 3.2 Each Member of the Ground Jury has the right and the duty to Eliminate or Disqualify any Horse which, in his opinion, is lame or unable to continue the Competition in accordance with Article C903.
- 3.3 The President of the Ground Jury is responsible for the conduct and control of the entire Event, in conjunction with the Technical Delegate.
- 3.4 The President of the Ground Jury will have overall control of the Duties and Responsibilities of the Ground Jury throughout the Event.
- 3.5 All the members of the Ground Jury will judge Driven Dressage. Usually the Ground Jury should not judge more than 45 Driven Dressage Tests in a day; however this number may be increased in exceptional circumstances, at

the sole discretion of the President of the Ground Jury. At Canadian Events a member of the Ground Jury, the event TD, or another EC-licensed Combined Driving Judge or TD may judge Cones when Driven Dressage and Cones Competitions are run concurrently.

- 3.6 The President of the Ground Jury is responsible for the control and publication of the results of the Competitions and of the Event.
- 3.7 At Canadian Events (more specifically, and in addition to those listed in 3.1 through 3.6 above).
  - a. The Ground Jury is responsible for the technical judging of all competitions, the final placing of competitors, and settling all problems, which may arise during the competitions.
  - b. The Ground Jury may not take into account any unofficial advice or observations from persons who are not members of the Ground Jury, or anything they know beforehand of the competitors or their horses/ponies,
  - c. The Ground Jury is responsible for all decisions, except where otherwise stated in these Rules.
  - d. The period of jurisdiction of the Ground Jury extends from one hour before the start of the event until one half hour after the announcement of the final results of the event for which the Ground Jury has been appointed. If an objection is made during the period of jurisdiction, the Ground Jury remains responsible until the objection is settled. (See Article C991).

## **ARTICLE C988 TECHNICAL DELEGATE**

*For EC-recognized events, refer to Competition Officials Section (Technical Delegates and Guest Cards).*

**988.2 Selection** – Refer to Appendix 1-A – Event Summary Table

### **988.3 Duties and Responsibilities**

- 3.2 To satisfy himself that the accommodation and catering arrangements for Horses, Athletes and Grooms, and training and exercise areas, are adequate and suitable in all respects.
- 3.3 Inspection of the Arenas and Courses to ensure that the technical facilities, requirements and organization are in accordance with the FEI Driving Rules and associated Regulations.  
*At EC-recognized events, EC rules apply.*
- 3.4 To ensure that the Courses and obstacles are fair and safe.
- 3.5 To instruct the OC and Course Designer to make any alterations which he considers necessary.
- 3.6 To ensure that timekeepers, ground observers, obstacle Judges and scorers are correctly instructed in their duties, including the use and reading of chronometers and stopwatches.
- 3.7 To report to the President of the Ground Jury that the relevant Course is ready for the start of the Competition.
- 3.8 To continue to supervise the technical conduct of the Event, including the transfer of data to the Scorers, after the President of the Ground Jury has assumed control of the Event.

### **988.4 Conflict of Interest**

See C607.2.a. and C103. *At EC-recognized events* see *Appendix AC-A. 2025 Rules of Equestrian Canada, Section C*



*Conflict of Interest.*

## ARTICLE C989 COURSE DESIGNERS

Refer to Appendix 1-A – Event Summary Table

### 989.2 Selection

- 2.2 The Course Designer may be the same person for each Competition or there may be a different Course Designer for each Competition.
- 2.3 The name or names of the Course Designer(s) must be published in the Schedule for the Event.
- 2.4 Only the Course Designer and his staff may alter or work on any part of the Driven Dressage Arena, the Marathon and Cones driving Courses. Any Athlete, or persons associated with an Athlete, who tamper with any part of the Arena or Courses will result in the Disqualification of that Athlete.
- 2.5 *For EC-recognized events the Course Designer should have competitive driving experience and work closely with the Technical Delegate and must follow all applicable rules. (See Non- Licensed Competition Personnel.)*

### 989.3 Duties

- 3.1 The Course Designer is responsible, under the supervision of the Technical Delegate, for:
  - a. Laying out and measuring the arena for Driven Dressage.
  - b. Laying out and measuring the Course and for the construction of the obstacles in Marathon.
  - c. Designing, laying out and measuring the Cones driving Course.
- 3.2 The President of the Ground Jury may only order the Competition to start when the Technical Delegate has reported that the relevant Course is ready.

### 989.4 Conflict of Interest

See FEI General Regulations Article 158 and [Art. CD-984](#) of these Driving Rules.

*At EC-recognized events see C608 and C103.*

## ARTICLE C990 CHIEF STEWARD

See C609 and C610

### 990.1 Appointment

*At EC-recognized events, the appointment of a Steward is at the option of the organizer. When utilized, the Chief Steward must be chosen from the EC or FEI roster of Level 1, 2 or 3 Driving Stewards.*

- 1.1 At all Championships the FEI will appoint a Chief Steward for Driving, selected from those on the list of FEI Stewards who have not been resident, in the country in which the Championship is to be held. The OC may send a proposal to be considered by the FEI at the time of the signature of the Host Agreement.
- 1.2 At all other International Events the OC must appoint a FEI Chief Steward, selected from the List of FEI Stewards.
- 1.3 The Chief Steward must be selected as per the level hereafter:

CATEGORY	CHIEF STEWARD
Championships (appointed by the FEI)	Level 3
CAIO	Level 3
CAI 3*	Level 2 or above
CAI 2*	Level 2 or above or level 1 upon agreement if the FEI

#### 1.4 Stewards

According to the size (number of overall Athletes at the Event) and type of Event, a sufficient number of Stewards must be appointed by the OC in consultation with the Chief Steward.

All Assistant Stewards at international Events should preferably hold at least a Level 1 status. If this is not the case, they must have received formal instruction in their specific responsibility from the Chief Steward.

### 990.2 Duties

#### 2.1 Driving Stewards are responsible for:

- Checking and measuring all the carriages after Driven Dressage and Cones, at the start of Section B in Marathon, and if necessary at the end of section B.
- Checking the bit of every Horse after Driven Dressage and Cones, and before and after Marathon. Unacceptable bits must be reported to the President of Jury.
- Checking that Athletes comply with the Rules pertaining to Advertising.
- Reporting to the President of the Ground Jury any contravention of the Rules pertaining to Carriages, lamps, tires, harness, bits or Advertising.
- Other duties as specified in the General Regulations.

#### 2.2 Stewards or any other Official must report to the President of the Ground Jury as soon as possible any incident of cruelty.

*At EC-recognized events the President of the Jury may assign the above responsibilities to other qualified individuals.*

#### 2.3 The Chief Driving Steward must be clearly identifiable throughout the whole Event.

### 990.3 Conflict of Interest

See FEI General Regulations Article 158 and [C984 and C103](#) of these Driving Rules.

## ARTICLE C991 APPEAL COMMITTEE

### 991.1 Composition

*At EC-recognized events an ad hoc Appeal Committee consisting of a President and two or three members may be appointed by the Organizer at the time an appeal is filed. When necessary, the Veterinary Official must be in attendance in an advisory capacity for all cases involving veterinary matters including alleged cruelty to the Horse.*

### 991.2 Appointment

*At EC-recognized events, see [Art. CD-991.1](#).*

### 991.4 Meetings

- 4.1 Appeals must be heard by all the members sitting together. The President will decide the time and place of the meeting.
- 4.2 The Appeal Committee must hear both sides of the case in appeals against decisions by individual Judges and Officials, and in cases referred to it by the Ground Jury.

### 991.5 Decisions

- 5.1 The decisions of the Appeal Committee are final, except in cases where monetary penalties have been awarded.
- 5.2 *At EC-recognized competitions there is no appeal against technical decisions under these Rules or for Driven Dressage test marks given by the Ground*

*Jury during a competition.*

## **991.6 Conflict of Interest**

See C103.

*Procedures for Objections and Appeals at EC-recognized events.*

*The following procedures are applicable when an Appeal Committee is appointed at EC-recognized events.*

*The owner, his agent authorized in writing, or the driver of a horse taking part in the Competition, is entitled to lodge an objection. The objection must be received within the appropriate time limit of the alleged violation.*

*6.1 Objections which need to be raised during the course of the Competition or at any time when the Ground Jury is responsible for the Competition must be submitted in the first place to the President of the Ground Jury. All the judges are therefore obliged to remain on the grounds or to be easily available until the time allowed for objections has expired. During the Event, all officials must be able to locate the President of the Ground Jury.*

*6.2 The President of the Ground Jury must defer to the President of the Appeal Committee any objections which he feels are beyond his discretion or responsibility and which should be handled as an official protest.*

*6.3 It is the responsibility of all bodies called upon to give decisions on objections and appeals, to make proper inquiries and to hear all sides of the case.*

*6.4 Time limits for objections and appeals during an event.*

*Objections submitted to the Ground Jury may be made verbally within the time limits outlined below. All appeals shall be in writing.*

*Objections against the eligibility of a Competitor or horse: not later than one hour before the start of the Competition.*

*a. Objections to a Marathon obstacle or to the course, the length or plan of the course: as soon after the inspection as possible but not later than 1800 on the day before Competition B.*

*b. Objections concerning irregularities or incidents during the competition: not later than half an hour after the announcement of the official results.*

*c. Objections concerning classification: as soon as possible after the competition and not later than half an hour after the announcement of the official results.*

*d. Objections concerning scoring may be raised up to one half hour after the official scores are posted for each Competition.*

*Exception: mathematical or transcription errors may be corrected up to one hour after the final classification for the event.*

*6.5 The Secretary of the Organizing Committee is responsible for recording the objections and subsequent decision of the Ground Jury and for delivering any appeal to the Appeal Committee.*

*6.6 The decision of the Technical Delegate with respect to objections arising prior to the commencement of the event, and the decision of the Ground Jury or the Appeal Committee with respect to the objections arising after the commencement of the event are final except where monetary penalties are awarded.*

*6.7 Deposits: A deposit of \$50 must accompany an appeal before it can be dealt with by the Appeal Committee. The deposit is refunded if the appeal is upheld. If the Appeal is not upheld, the deposit is forfeited to the Organizing Committee.*

## **ARTICLE C992 VETERINARY DELEGATE AND VETERINARY COMMISSION**

*During EC-recognized competitions (non-FEI), if any conflict arises between FEI and EC Veterinary Regulations, the Veterinary Regulations and procedures of EC shall prevail.*

### **992.3 At EC-recognized events:**

- 3.1 *The Organizing Committee shall appoint at least one Veterinarian as the Veterinary Official responsible for carrying out these Rules. He is the Official Advisor on all veterinary matters to the Organizing Committee and to the Appeal Committee and during the Competition to the Ground Jury.*
- 3.2 *The veterinary supervision of events is the responsibility of the Veterinary Official and his assistants, forming a Veterinary Commission. The Veterinary Commission shall arrange for or assist in the treatment of horses entered in the event, and answer any questions and settle any problems concerning the health, hygiene, food, drug and veterinary control measures.*
- 3.3 *The Organizing Committee is responsible for providing the necessary facilities and the Veterinary Commission is responsible for the organization of the Veterinary Examinations and Inspections.*
- 3.4 *It is vitally important to ensure that an adequate veterinary first aid service is within quick and easy reach of all areas of the competition venue, including all parts of the course of the Marathon, and transportation facilities for severely injured or dead horses must be within easy reach of all obstacles and the veterinary first aid stations.*
- 3.5 *The Veterinary Commission may bring to the attention of the Technical Delegate any features of the event or venue which are considered to be dangerous and might cause injury to the horses, particularly the Marathon courses. Special attention should be paid to soft, slippery or rough surfaces, to the construction of obstacles and to any projecting nails, spikes, sharp corners, dangerous roots or branches.*
- 3.6 *Veterinary services must be available at the compulsory rest halt before Section B, and a veterinary first aid station must be established at the finish of the Marathon course, properly equipped to deal with injuries and exhaustion. All horses completing the course should be checked immediately after finishing for injuries, their physical state assessed, including respiration, pulse and temperature as deemed advisable, and again thirty minutes later if considered necessary.*

## **ARTICLE C993 VETERINARY SERVICES MANAGER /TREATING VETERINARIAN**

993.1 At CAIs A Veterinary Services Manager/Treating Veterinarian appointed by the OC must be available to the Jury, under arrangements approved by the President of Jury.

## **ARTICLE C995 ROTATION OF OFFICIALS**

Rotation of Officials: a Judge/Technical Delegate/Course Designer may not have been the Judge/Technical Delegate/Course Designer at the same Event for more than 3 consecutive years without taking at least one year break.

FEI ANNEXES

FEI ANNEX 1 - DIAGRAM OF THE DRIVEN DRESSAGE ARENA

100m x 40m

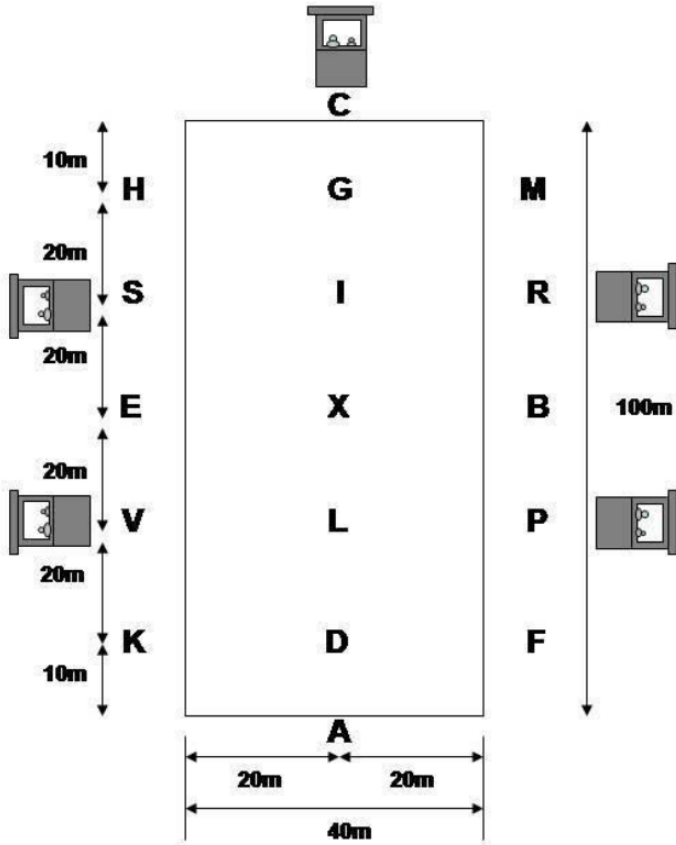

**DIAGRAM OF THE SMALL DRIVEN DRESSAGE ARENA**  
**80m x 40m**

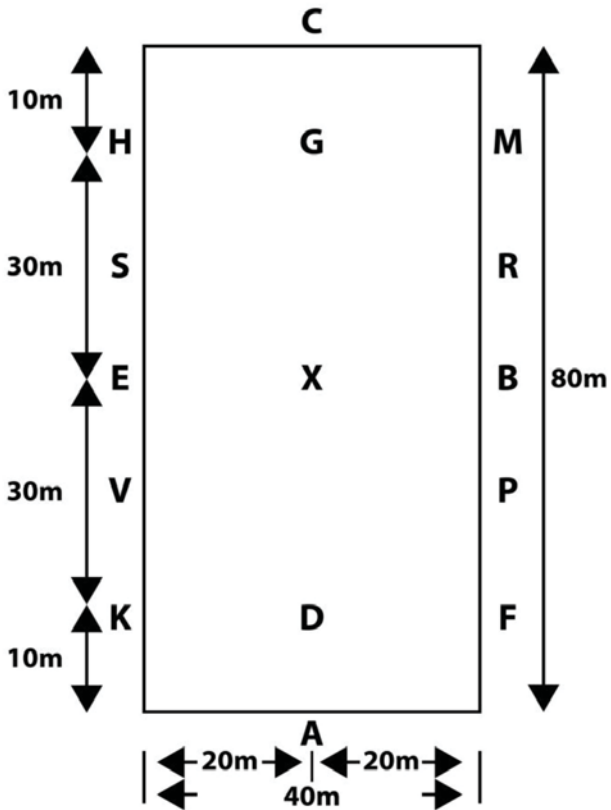

**DIAGRAM OF THE DRIVEN DRESSAGE ARENA FOR  
TEST 3\*C H4  
(Test 3\*A/B HP4: see Article 953.1)**

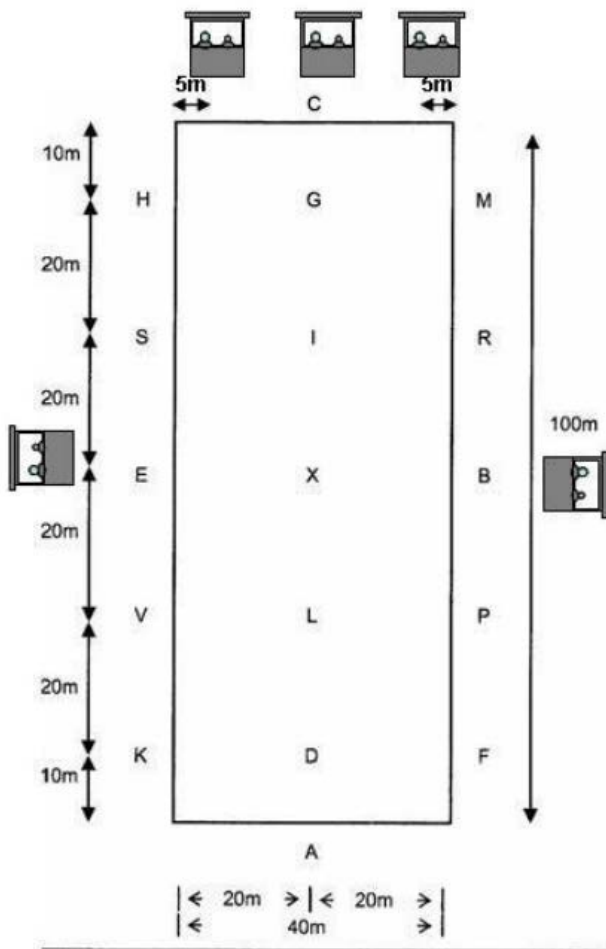

## FEI ANNEX 2 - CONES: CLOSED MULTIPLE OBSTACLES

(Elements must be separated 20cm - 40cm)

### 1. Single "L"

Construction:

Supports – 40cm to 60cm from ground to top of rail

Elements – must be free-standing; parallel or perpendicular; single or sectioned rails; separated by 20cm-40cm spacing

Markers – a pair of red and white markers, set within 15cm

Element. « A » at the IN gate and « B » at the OUT gate.

**Horse:** (minimum measurements)

	<u>IN</u>	<u>A1</u>	<u>A2</u>	<u>B1</u>	<u>B2</u>	<u>OUT</u>
Single	3	8	11	8	11	3
Pair	3	8	11	8	11	3
Tandem	4	8	12	8	12	4
Four-in-hand	4	8	12	8	12	4

**Pony:** (minimum measurements)

	<u>IN</u>	<u>A1</u>	<u>A2</u>	<u>B1</u>	<u>B2</u>	<u>OUT</u>
Single	3	8	11	8	11	3
Pair	3	8	11	8	11	3
Tandem	3	8	11	8	11	3
Four-in-hand	3	8	11	8	11	3

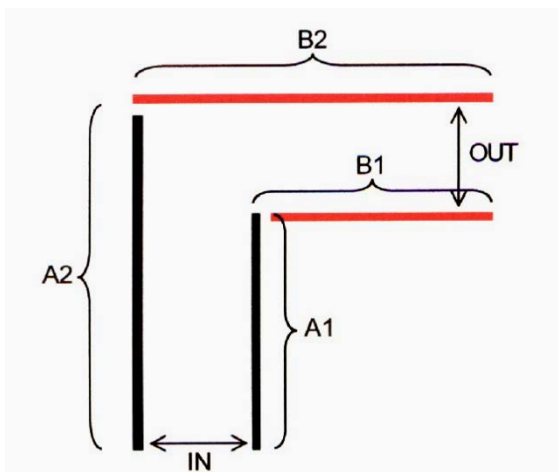



## 2. Double “L”

Construction:

Supports – 40cm to 60cm from ground to top of rail

Elements – must be free-standing; parallel or perpendicular; single or sectioned rails; separated by 20cm-40cm spacing

Markers – indicating each section as follows :

A – within 15 cm of IN

B – coloured or wrapped rails or markers on the ground.

C – within 15 cm of OUT

**Horse:** (minimum measurements)

	<u>IN</u>	<u>A1</u>	<u>A2</u>	<u>B</u>	<u>B1</u>	<u>B2</u>	<u>C</u>	<u>C1</u>	<u>C2</u>	<u>OUT</u>
Single	3	5	9	4	10	9	4	9	5	4
Pair	3	5	9	4	10	9	4	9	5	4
Tandem	4	5	10	5	10	9	5	10	5	5
Four-in-hand	4	5	10	5	10	9	5	10	5	5

**Pony :** (minimum measurements)

	<u>IN</u>	<u>A1</u>	<u>A2</u>	<u>B</u>	<u>B1</u>	<u>B2</u>	<u>C</u>	<u>C1</u>	<u>C2</u>	<u>OUT</u>
Single	3	5	9	4	9	9	4	9	5	4
Pair	3	5	9	4	9	9	4	9	5	4
Tandem	3	5	9	4	9	9	4	9	5	4
Four-in-hand	3	5	9	4	9	9	4	9	5	4

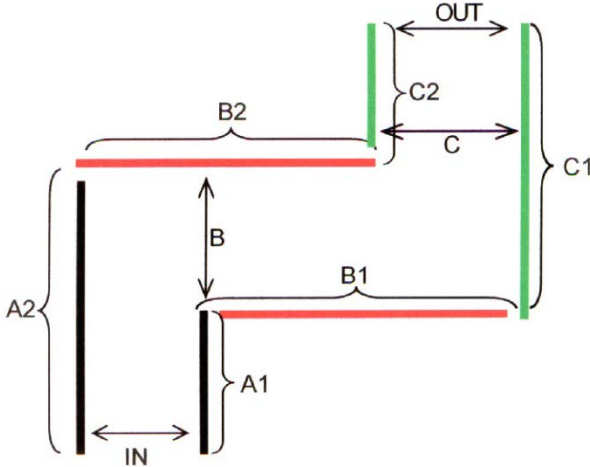

### 3. Single “U”

Construction:

Supports – 40cm to 60cm from ground to top of rail

Elements – must be free-standing; parallel or perpendicular; single or sectioned rails; separated by 20cm-40cm spacing

Markers – indicating each section set as follows :

A – within 15 cm of IN

B – coloured or wrapped rails or markers on the ground.

C – within 15 cm of OUT

**Horse:** (minimum measurements)

	<u>IN</u>	<u>A1</u>	<u>B</u>	<u>B1</u>	<u>B2</u>	<u>C1</u>	<u>OUT</u>
Single	3	9	4	5	7	9	4
Pair	3	9	4	5	7	9	4
Tandem	4	10	5	5	9	10	5
Four-in-hand	4	10	5	5	9	10	5

**Pony :** (minimum measurements)

	<u>IN</u>	<u>A1</u>	<u>B</u>	<u>B1</u>	<u>B2</u>	<u>C1</u>	<u>OUT</u>
Single	2	8	3	5	5	8	3
Pair	3	9	4	5	7	9	4
Tandem	3	9	4	5	7	9	4
Four-in-hand	3	9	4	5	7	9	4

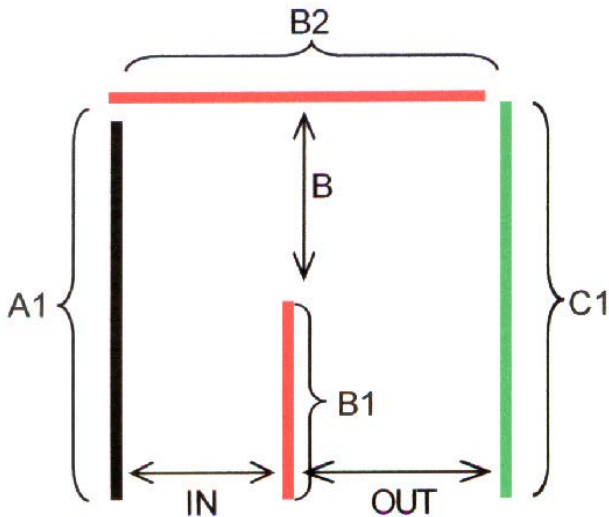

#### 4. Double “U”

Construction:

Supports – 40cm to 60cm from ground to top of rail

Elements – must be free-standing; parallel or perpendicular; single or sectioned rails; separated by 20cm-40cm spacing

Markers – indicating each section set as follows:

A – within 15 cm of IN

B, C – coloured or wrapped rails or markers on the ground.

D – within 15 cm of OUT

**Horse:** (minimum measurements)

	<u>IN</u>	<u>A1</u>	<u>B</u>	<u>B1</u>	<u>B2</u>	<u>C</u>	<u>C1</u>	<u>C2</u>	<u>D1</u>	<u>OUT</u>
Single	3	12	4	8	7	4	8	8	12	4
Pair	3	12	4	8	7	4	8	8	12	4
Tandem	4	13	5	8	9	5	8	10	13	5
Four-in-hand	4	13	5	8	9	5	8	10	13	5

**Pony :** (minimum measurements)

	<u>IN</u>	<u>A1</u>	<u>B</u>	<u>B1</u>	<u>B2</u>	<u>C</u>	<u>C1</u>	<u>C2</u>	<u>D1</u>	<u>OUT</u>
Single	2	9	3	6	5	3	6	6	9	3
Pair	3	12	4	8	7	4	8	8	12	4
Tandem	3	12	4	8	7	4	8	8	12	4
Four-in-hand	3	12	4	8	7	4	8	8	12	4

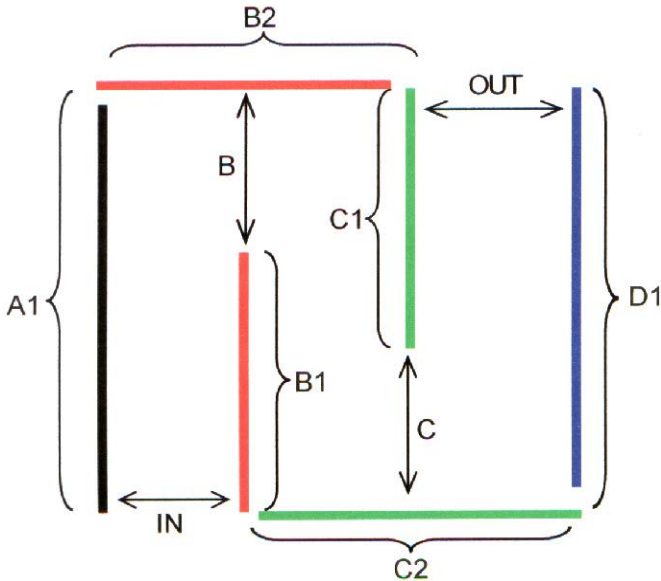

## 5. Box

Construction:

Supports – 40cm to 60cm from ground to top of rail

Elements – must be free-standing; parallel or perpendicular; single or sectioned rails; separated by 20cm-40cm spacing

Markers – indicating each section set as follows:

A – within 15 cm of IN

B – coloured or wrapped rails or markers on the ground.

C – outside but within 20 cm of element C

**Horse:** (minimum measurements)

	<u>IN</u>	<u>A1</u>	<u>A2</u>	<u>B</u>	<u>B1</u>	<u>B2</u>	<u>C1</u>	<u>C2</u>	<u>OUT</u>
Single	3	4	8	4	7	8	4	7	4
Pair	3	4	8	4	7	8	4	7	4
Tandem	4	5	9	5	8	10	5	8	5
Four-in-hand	4	5	9	5	8	10	5	8	5

**Pony :** (minimum measurements)

	<u>IN</u>	<u>A1</u>	<u>A2</u>	<u>B</u>	<u>B1</u>	<u>B2</u>	<u>C1</u>	<u>C2</u>	<u>OUT</u>
Single	2	3	7	3	6	6	3	6	3
Pair	3	4	8	4	7	8	4	7	4
Tandem	3	4	8	4	7	8	4	7	4
Four-in-hand	3	4	8	4	7	8	4	7	4

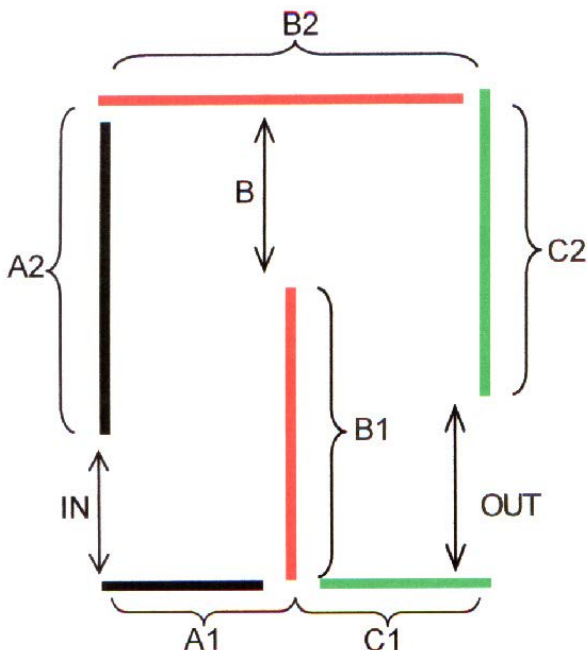

## 6. Double Box

Construction:

Supports – 40cm to 60cm from ground to top of rail

Elements – must be free-standing; parallel or perpendicular; single or sectioned rails; separated by 20cm-40cm spacing

Markers – indicating each section set as follows :

A – within 15 cm of IN

B, C – coloured or wrapped rails or markers on the ground.

D – within 15 cm of OUT

**Horse:** (minimum measurements)

	<u>IN</u>	<u>A1</u>	<u>A2</u>	<u>B</u>	<u>B1</u>	<u>B2</u>	<u>C</u>	<u>C1</u>	<u>C2</u>	<u>D1</u>	<u>D2</u>	<u>OUT</u>
S	3	4	8	4	7	8	4	7	8	7	4	4
P	3	4	8	4	7	8	4	7	8	7	4	4
T	4	5	9	5	8	10	5	8	10	8	5	5
4	4	5	9	5	8	10	5	8	10	8	5	5

**Pony:** (minimum measurements)

	<u>IN</u>	<u>A1</u>	<u>A2</u>	<u>B</u>	<u>B1</u>	<u>B2</u>	<u>C</u>	<u>C1</u>	<u>C2</u>	<u>D1</u>	<u>D2</u>	<u>OUT</u>
S	2	3	8	3	7	6	3	7	6	7	3	3
P	3	4	8	4	7	8	4	7	8	7	4	4
T	3	4	8	4	7	8	4	7	8	7	4	4
4	3	4	8	4	7	8	4	7	8	7	4	4

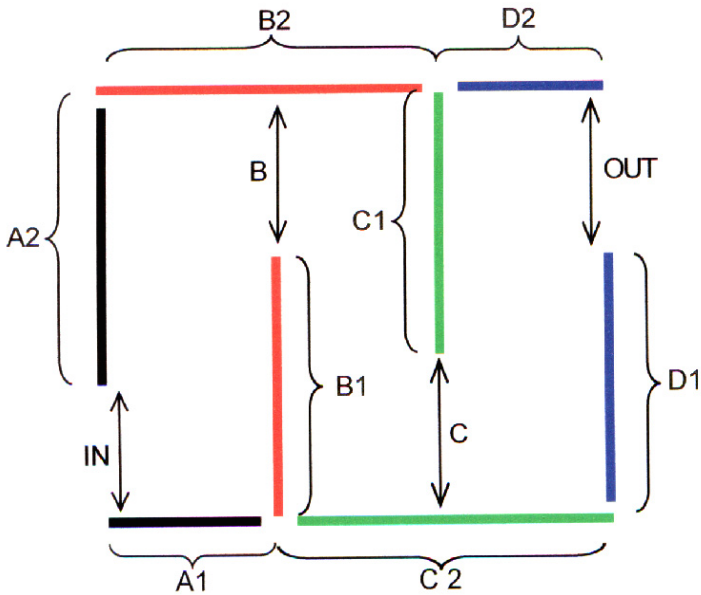

## FEI ANNEX 3 - CONES : OPEN MULTIPLE OBSTACLES

### 1. SERPENTINE

(Article C973.3.1)

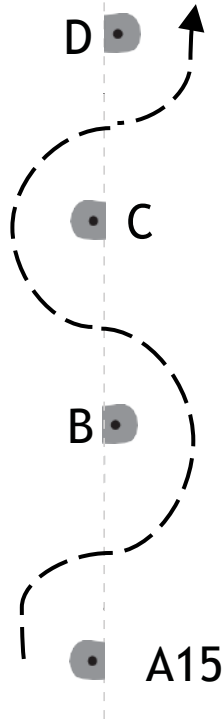

#### Minimum Distance between pair of Cones (center to center)

	Horses	Ponies
Four-in-hand	10-12 m	8-10 m
Pair	6-8 m	6-8 m
Single	6-8 m	6-8 m

Cones to be set in a straight line with markers on opposite sides.

*[“A” may start with either red or white, followed by letters of opposite colour to create 3 possible gates.]*

## 2. ZIG-ZAG

(Article C973.3.2)

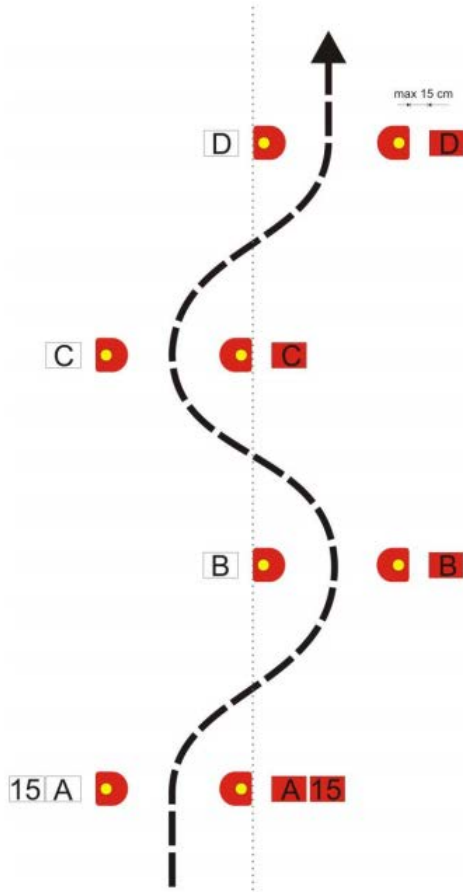

Minimum distance between pair of cones (center to center)

	Horses	Ponies
Four-in-hand	11-13 m	9-11 m
Pair	10-12 m	9-11 m
Single	10-12 m	9-11 m

Centre line cones to be set in a straight line, either in front, at the middle or at the rear of the cone (as shown above) with markers placed within 15 cm.

The centre line cone shall not be adjusted; the outside cone shall be set to the required track width.

### 3. The Wave

(Article C973.3)

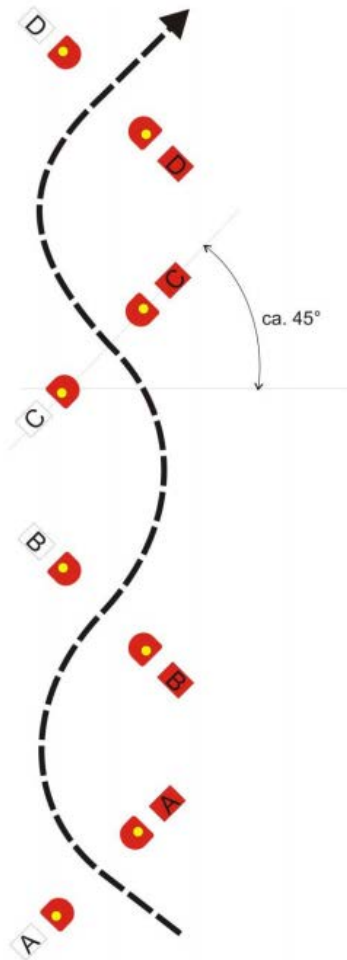

	Four-in-hand	Pairs	Singles
Minimum distance between cones (red A to red B; white B to White C; red C to red D).	Minimum 10 m Maximum 12 m	Minimum 8 m Maximum 10 m	Minimum 8 m Maximum 10 m
Angle of pair of Cones to the middle of the Wave	<u>45°</u>	<u>45°</u>	<u>45°</u>



## FEI ANNEX 4 – CONES : THE BRIDGE AND THE WATER OBSTACLE

(Article C973.4)

Dimensions:

10m x 3m; maximum 20cm high with fan shaped wings.

Cones required at both ends adjacent to bridge, with red and white letters A at entrance and letters B at exit, set at a constant clearance of 2.0 metres for all classes.

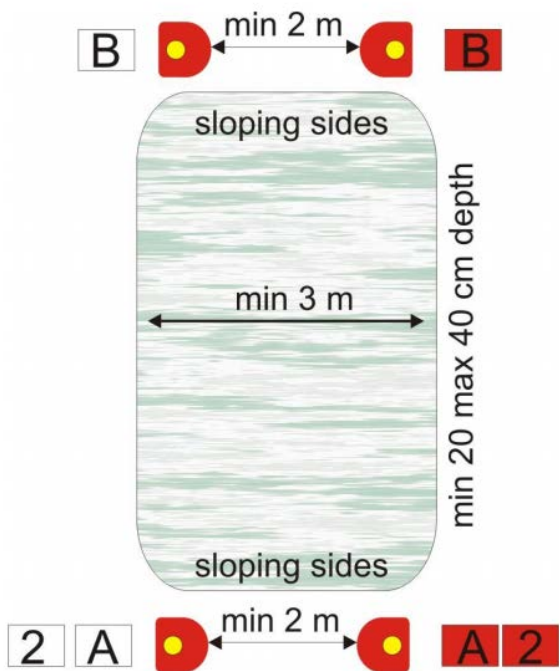

# FEI ANNEX 5 - CONES : ALTERNATE/OPTION CONES

See C974.1.3)

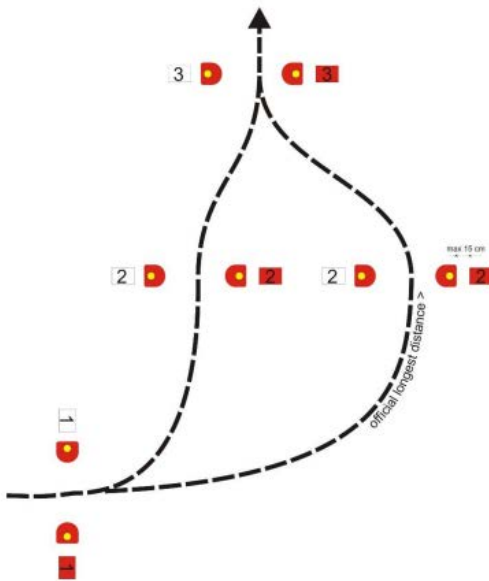
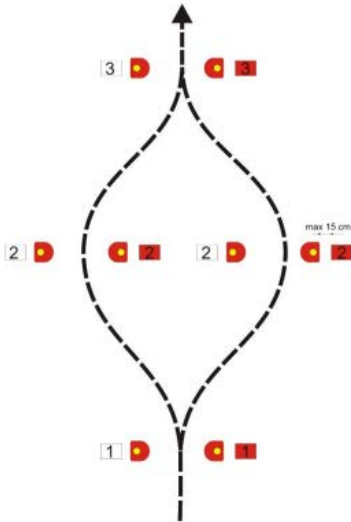

## FEI ANNEX 6

### CONES: OXER

See C973.1)

An oxer will be composed of 2 pairs of cones in a straight line. The distance between the first set of cones and the second set will be between 1.5 and 3 metres, at the option of the Course Designer. The oxer counts as a single obstacle and the maximum penalty points for knocking down up to 4 balls is 3 penalty points in total. The first set of cones will have the number of the obstacle and be marked with red and white flags and the second set of cones will be marked with red and white flags. This obstacle will be judge as a single obstacle. A maximum of five oxers are allowed in a Cones course.

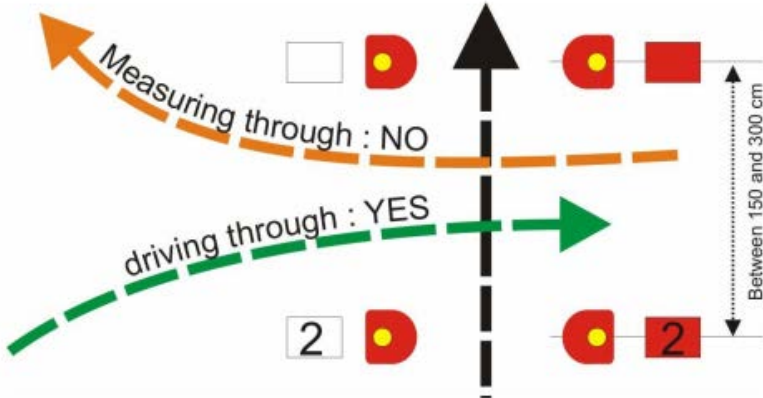

Distance between the two pairs of cones : Minimum 1.5 m ; maximum 3 m

## FEI ANNEX 7 – CONE SPECIFICATIONS

FEI approved driving cones – indoor and outdoor

### Cones

- Material: Plastic, stable enough for use and indestructible
- Height: 30-50 cm
- Platform: 400 x 425 mm
- Angle: 60°
- Ball hollow on the top of the cones: 40mm Ø diameter
- Color: No restriction. Reduced Cones Ref. Article 974.1.2
- Weight<sup>1</sup> of the Cones: Minimum 2.5 kg.

### Ball:

- Size: 72 mm Ø diameter
- Weight<sup>1</sup>: 200 gr

### Red and White markers

- Outdoor: strongly recommended: stable enough for use
- Markers: dimensions: 330 x 330 mm
- Indoors: Sleeves

<sup>1</sup> Weights: a tolerance of +/- 5% is acceptable.



## FEI ANNEX 8 – ADDENDUM FOR PARA-DRIVING

### 1. Para Equestrian Driving events

- 1.1. The object of International Para Driving Events is to provide and develop Competition opportunities for drivers with impairments.
- 1.2. To classify all Athletes and give them a Functional Profile and a Grade, enabling them to compete on an equitable basis using agreed compensating aids according to their respective degree of impairment.
- 1.3. Para Driving Athletes are allowed to compete in FEI Driving Competitions using compensating aids in accordance with their respective degree of impairment as defined on the FEI Classification Master list of active Para Driving Athletes.

### 2. Para Equestrian Athlete Classification

- 2.1. It is a condition of participation that the Athlete has a permanent, verifiable and measurable physical impairment which is supported by medical evidence and satisfies the minimal impairment criteria as detailed in the FEI Para Equestrian Classification Rules.
- 2.2. All Athletes must undergo Athlete evaluation by two FEI accredited Para Equestrian classifiers before they may take part in a Competition. An Athlete will be allocated a Grade for competition based on their functional Profile as described in the FEI Para Equestrian Classification Rules. This functional Profile may need to be reassessed or reviewed on more than one occasion.
- 2.3. Following Classification Athletes will be assigned a Tracking Code of Observation Assessment (OA) or a Grade Status of Review (R) or Confirmed (C) and all relevant details will be included on the Classification Master List of active Para Driving Athletes and published on the FEI website.
- 2.4. Where required, the Classifiers must be invited to arrive 24 hours before the draw takes place. All New Athletes, Athletes with Review Grade status or Review with Fixed Review date Status where the date has passed, or those with Confirmed status who have been granted approval for reclassification, must undergo evaluation before the draw takes place. Time must be allowed for the Classifiers to complete their task, notify the OC of the results of the evaluations and inform relevant officials of the Athlete's compensating aids to be used.
- 2.5. All relevant details regarding an Athlete's classification and compensating aids required by the Athlete will be included on the Classification Master List of active Para Driving Athletes and published on the FEI website.
- 2.6. Protests and Appeals in relation to an Athlete's classification are to be dealt with in accordance with FEI procedures as outlined in FEI Para Equestrian Classification Rules.

Refer to the FEI website for:

- Guidelines for Organising Classification at Para Equestrian Events
- FEI Para Equestrian Classification Rules
- Classification Master List of active Para Driving Athletes

### 3. Grades

Athletes are divided into 2 Grades: Grade I and Grade II.  
Grade II Athletes have greater functional ability than Grade I PE Athletes.

#### **4. Classes**

A Para Driving Athlete may enter a higher Grade than his classification indicates.

A Para Driving Athlete may not enter a lower Grade than his classification indicates.

Grade I Athletes and Grade II Athletes shall be in separate classes.

#### **5. Eligibility**

Only those Athletes with impairments who are capable of driving Driven Dressage Tests, Cones and Marathons independently and to the FEI rules are allowed to compete.

The Profile and Grade shall be noted on the entry form, programme and score board.

The OC and Technical Delegate have the right to refuse entry but they must give the reason for the refusal in writing.

#### **6. Horses**

Para Driving Athletes may use either a Horse or a pony. It must be stated on the entry form which will be used.

#### **7. Equipment**

- 7.1. If the Para Driving Athlete wishes to drive in a wheelchair, the wheelchair must be secured. Straps and clamps for the wheelchair must be of a 'quick release' variety. In the interests of safety, sloping cushions, shell seats, waist-high seat sides and arm-rests are permitted.
- 7.2. A Para Driving athlete must be able to fall free from the carriage A Para Driving Athlete may be attached on the carriage for support with a lap belt or a 4 point belt, but there must be a quick release system, Supporting aids with quick release systems must be checked by the Chief Steward before the Driven Dressage and before the Marathon.
- 7.3. Reins may not be attached to the Para Driving Athlete in any manner that could prevent the Para Driving Athlete from falling free from the carriage.
- 7.4. Driving with a second set of reins or divided reins is not allowed
- 7.5. A Para Driving Athlete may drive with one or two hands
- 7.6. A Para Driving Athlete is allowed to do one handed movements with two hands, when mentioned in the Classification Master List of active Para Driving Athletes following the classification of the Athlete.

#### **8. Compensating Aids**

- 8.1. Standard Compensating Aids are aids or equipment, other than approved harness, carriages or equipment as outlined in the FEI Driving Rules, which may be used by the athletes across all functional profiles. Standard Compensating Aids are allowed to be used by all Athletes and must be noted on the Classification Master List of active Para Driving Athletes following the classification evaluation.

- Lap belt held by groom or with quick release mechanism
- Salute with head only (SWHO):

The Para Driving Athlete may salute with the head only so that contact is maintained on the reins at all times.

- Handbrake

- Motor Vehicle to Walk the Course (MVWC)

8.2. Profile-specific compensating aids are aids or equipment, other than approved harness, carriages or equipment, which may be used by nominated profiles and must be noted on the FEI Classification Master List following Classification evaluation. Please refer to Art. 15.2 of the FEI Manual for Classifiers for more details about the profile specific compensating aids.

- 4-point belt held by groom or with quick release mechanism
- Looped or knotted reins
- Connecting rein bar
- Strap on whip

If not noted on the Classification Master List of active Para Driving Athletes, use of the brake and /or the whip by the groom will be punished by 20 penalty points each time.

8.3. Non-Standard compensating aids are aids, other than those above, required by an individual athlete and not described specifically in the rules. The aid is prescribed specifically for the athlete to enable them to drive without providing an advantage over other athletes within the same Profile or Grade. These aids may include modifications to a Standard or Profile-specific Compensating aid, or a piece of non-Standard equipment custom-made for the athlete. The use of a non-standard compensating aid must be approved by the Para Driving Working Group.

8.3.1. The use of a non-standard compensating aid must be approved by the FEI Para Driving Working Group before the Event at which it is to be used takes place. Any such request must be submitted to the FEI in writing with supporting documentation (medical documentation, aid description, photos, video etc.) at least two weeks before the day of the horse inspection for the event to which it will apply. If approved by the FEI Para Driving Working Group, the aid is added for the Athlete to the Classification Master List of active Para Driving Athletes.

8.3.2. For Athletes who have not previously undergone a Classification Evaluation, at their first competition (where they are being Classified) non-standard compensating aids must be approved by the TD, Chief Steward, Chief Classifier and President of the Ground Jury. To be used at all following competitions the full request must be made to the FEI Para Driving Working Group and listed on the Classification Master List of active Para Driving Athletes.

## **9. Assistance**

The ultimate responsibility regarding the use of permitted assistance lies with the Para Driving Athlete.

- 9.1. A groom must be over 18 years old. The NF must ensure that the groom has knowledge in Driving
- 9.2. Grade I Athletes must have a groom on the carriage. In Driven dressage and Cones an additional groom must be available at the ringside to assist every Grade I Para Driving Athlete.
- 9.3. In section A of the Marathon the additional groom may accompany a Grade I Para Driving Athlete either in the carriage or following behind the carriage on a bicycle, moped, ATV(quad bike) or similar. In Section B of the Marathon all Grade I Para Driving Athletes must be accompanied by an additional groom either in the carriage or followed by a team member behind the carriage on a bicycle, moped, ATV(quad bike) or similar.

Team members on bicycles or mopeds etc., are not permitted to drive through the obstacles but must wait for the Para Driving Athlete to complete the entire obstacle before proceeding.

**10. Drugs**

Horses/ponies may be dope tested.

**11. Entries World Driving Singles Championship for Para-Equestrian.**

- 11.1 Each NF may enter a maximum of six Single PE Athletes with a maximum of two Horses per entry on the Nominated Entry List and three Single PE Athletes with a maximum of one Horse per PE Athlete on the Definite Entry List.
- 11.2 Each team must include at least one (1) Athlete from Grade I.
- 11.3 Should a NF only be able to send two PE Athletes, they must be entered as a team.
- 11.4 Each NF is entitled to send a Chef d'Equipe and Veterinarian, both of whom will be accorded the same privileges as the PE Athletes.
- 11.5 A NF which cannot send a team may enter one PE Athlete as an Individual under the conditions set out in Article 912.
- 11.6 A reserve Horse from the Nominated List may be entered per national team. The PE Athlete who uses the reserve Horse will be eligible for the individual and team competition. The reserve Horse can only be substituted once, not later than one hour before the start of Driven Dressage and notified in writing to the Organiser.

**12. Additional requirement for OCs:**

- 12.1 Scoreboard and Scoreboard attendant. The Scoreboard shall be of a size and in location where it is easy to read both standing and from a wheelchair.
- 12.2 Transport Manager with Athletes and suitable vehicles for transporting Athletes, Sponsors and Officials and for emergency vehicles.
- 12.3 Wheelchair accessible ramps for all facilities used by Athletes.

**13. Starting order in Marathon (Ref Article 948)**

Ponies may start before Horses in Marathon at the option of the OC and TD, but the starting order in each class will be as per article 948.

**14. Cones**

The time allowed will be calculated for a speed of 230 m/min for both Horses and ponies. For Drive-offs a speed of 240 m/min may be used.



## **FEI ANNEX 9 – BADGE OF HONOUR**

Badges of honour will be awarded to Athletes who complete all three competitions (without retirement, disqualification or Elimination) at a World or Continental Championships to the following scale:

- a) a Gold badge for six completions
- b) a Silver badge for four completions
- c) a Bronze badge for two completions

For full description of privileges, please refer to Article 132 of the FEI General Regulations.

## FEI ANNEX 10 - DEFINITIONS

**Children:** See *FEI General Regulations, Appendix A - Definitions*

**Competition –**

a component of a -Driving Event Driven Dressage, Marathon, Cones and Combined Marathon-Cones..

**Dismounting:**

The deliberate departure of an Athlete or Groom from the carriage or the accidental leaving (falling off) of the carriage by the Athlete or Grooms

**Entry:** In Driving, the unit composed by the Athletes (Drivers), horse(s), Groom(s), harness and Carriage appropriate to the turnout as defined in these Rules

**Event Official :** See *FEI General Regulations* and Annex 3.

**Horse:** Refers to a Horse or Pony authorized to compete under *Chapter 6*.

**Junior:** See *FEI General Regulations, Appendix A – Definitions*.

**Organising Committee “OC”:** see *FEI General Regulations*.

**Period of an Event:** See *FEI General Regulations, Appendix A – Definitions*.

**Schedule:** The official form approved by the FEI outlining the relevant information of of an event, including but not limited to the dates and location of the Event, the dates by which entries must be received, the Disciplines in which Competitions will be held, the programme of Competitions, the categories, nationalities and other relevant details of invited Athletes and Horses, the stabling and accommodation available, the value of the prizes and their distribution, and any other relevant details.

**Showgrounds:** All land used for the Competitions comprising the Event, and areas for exercising and warm-up, stabling and the parking of Carriages.

**Turnout:** A Carriage together with the Horses, harness, Athlete and Grooms.

**Young Athletes:** See *FEI General Regulations, Appendix A – Definitions*.

## APPENDICES

### APPENDIX 9-A – DRIVING TRIALS

#### General Conditions (differences)

1. A Driving Trial consists of Driven Dressage, Cones and a Section B Marathon only, held on one day. Rules for a Driving Trial will be based on the Equestrian Canada rules for Combined Driving Events with the following modifications.
2. Driving Trial divisions may include Training, Preliminary, Intermediate, Advanced or hybrid divisions consisting of CAC combinations. Organizers should limit their number of divisions based on abilities of the Organizing Committee and Course Designer.
3. **A Veterinarian and medical personnel** capable of cardiac resuscitation, such as EMTs, First Responders, or a trained nurse or physician should be on the grounds during the Marathon. If not possible, they must be “on call” with a reasonable response time.
4. No **Horse Inspection** required before competition. Only the “In-Harness Examination” described in Article C935.4 is applicable to the schedule of a Driving Trial.
5. **Presentation** will be judged on the move during the Dressage test. There will be a safety check before the Marathon. Entries must complete the *Safety Checklist* as in Appendix 1-B.
6. **Dressage:** if the arena is less than 40m x 80m, “Arena Dressage Tests” may be used.
7. **Marathon:**
  - a) Section B only to a maximum of 10 km (Article C960.2.7(d)).
  - b) For all divisions, the number of obstacles may not exceed the number of kilometres.
  - c) Distance between obstacles must not be less than 250 m for Training and Preliminary divisions, and not less than 500 m for Intermediate and Advanced division. Distance between VSE-only obstacles may not be less than 250 m for all divisions. The TD may grant an exception.
  - d) In exceptional circumstances, the TD may authorize more than one Obstacle per kilometre provided the maximum speeds are lowered and all minimum distances and distance between the last obstacle and the finish are followed
8. A **capable Navigator/Groom** must be competition age 12 or over for Training and Preliminary Divisions, and age 14 or over for Intermediate and Advanced Divisions. Anyone under 18 must have parental consent and approval of the Organizer before being allowed in the competition. (See Article C912, C912.5-6 and C102.6).
9. **Officials:**
  - a) The Ground Jury may consist only of a President in accordance with Appendix 1-A
  - b) One TD recommended under 16 entries, required 16 entries and over.
  - c) If no TD, the Judge shall be responsible for approving the Prize List and other TD duties.

- d) Intermediate and Advanced division competitions require a second qualified judge with previous jury-member experience in adjudicating FEI dressage tests.
  - e) The Technical Delegate may have no additional duties during the Marathon.
10. There will be no **Appeals Committee**: the Ground Jury's decisions will be final.
  11. **Athletes and Navigator/grooms** may compete more than once, scheduling permitting at Management's discretion.
  12. **Equines** may compete in a second entry for Dressage and Cones only.
  13. **Competition:**
    - a) All current specifications for divisions regarding dressage tests, speeds, distances and clearances, etc. are to be followed (See Appendix 9-E, *Quick Reference Guide*). The marathon shall be Section B only, maximum 10 km (Article C941.1.9). For all divisions, the number of obstacles may not exceed the number of kilometres. In exceptional circumstances, the TD may authorize more than one Obstacle per kilometre provided the maximum speeds are lowered and all minimum distances are followed and between the last obstacle and the finish.
    - b) For Advanced division:
      - (i) in all competitions the standard track width and weight requirements are waived. Minimum clearance for Cones setting: wheel track width plus 15 cm for VSE, 20 cm for horse/pony in single and pair, 30 cm for tandem, unicorn and four-in-hands.
      - (ii) in marathon, up to six gates per obstacle may be used.
  14. **Course inspection**: if the same space is used for more than one competition, the Official(s) will inspect the course immediately prior to the official **Course Walk**. The course shall be open for a reasonable time (not less than 30 minutes) to allow Athletes to make their inspection. Printed maps and diagrams are not required.

## APPENDIX 9-B - ARENA TRIALS

### 1. General Principles

The Arena Driving Trial may be held in a suitable size arena, or outdoors in an enclosed arena.

- 1.1 **Rules** for Arena Driving will be based upon the Equestrian Canada Rule books for Combined Driving events. Certain modifications will be required to accommodate facility dimensions. Competition rules so modified are noted in this appendix.
- 1.2 **Facilities:** Size of the arena will be at the discretion of the organizers.
- 1.3 **Veterinarian:** must be on call. No horse inspection required.
- 1.5 **Officials:** one Combined Driving Judge required (as per Appendix 1A Event Summary Table); one TD recommended under 26 entries, required 26 entries and over. If no TD, the Judge shall be responsible for approving the Prize List. One official who is properly credentialed as both Combined Driving Judge and Combined Driving Technical Delegate may fill both positions at the same event.
- 1.4 **Medical facility:** An EMT must be on call.
- 1.6 **Pace:** Cantering limitation on courses will be at the discretion of the organizer and officials and published in the Prize list. Cantering should be restricted to 4 wheel vehicles with hard rubber tires and non-wire spoke wheels (Article C964.4).
- 1.7 **Safety Check:** recommended prior to first class.
- 1.8 **Presentation:** Will not be scored.
- 1.9 **Dress:** Clean, neat marathon dress may be worn during all 3 sections of competition.
- 1.10 **Athletes and Grooms:** May participate with more than one entry. See Article C912 and C102.6 for competition age limitations for juniors. Grooms may ride in/on the vehicle in competition. During Driven Dressage or Cones competitions, grooms giving verbal or physical directions, or sliding, lifting or moving the vehicle in any way will incur immediate elimination for the entry.
- 1.11 **Vehicles:** The same vehicle may be used in all 3 competitions.
- 1.12 **Classes:** At the discretion of the organizer. May be divided by horse/pony/donkey/mule size, single/multiple turnout, two-wheeled or four-wheeled vehicles. Athlete experience or by the dressage test. Classes may be split as entries warrant.
- 1.13 **Classification:** Athletes will be ranked by class in reverse order of total penalty points accumulated in all 3 competitions.
- 1.14 **Participation:** Athletes and Navigator/Grooms may compete more than once, scheduling permitting.

### 2, Driven Dressage

- 2.1 Letters A and C will be at the mid-point of the short side of the arena. Letters B and E will be at the mid-point of the long side of the arena. Letters H, M, K, and F will be measured 10 meters from the corners of the arena.
- 2.2 If the arena is of a suitable size, a regular ADS Driven Dressage Test should be used. Otherwise, the Arena Dressage Tests shall be used.
- 2.3 When sufficient room is not available for warm up outside the perimeter of the arena, the Organizer may choose, with the approval of the Judge, either:

- a) The opportunity to warm up inside the arena before the class starts, or
  - b) A warm up of approximately one minute inside the arena after the previous turnout has exited.
  - c) Entries must be notified prior to the class.
- 2.4 Scoring will be as indicated on the dressage test and converted to penalty points.
- 2.5 Presentation is not scored.
- 2.6 Grooms are not permitted to handle the reins, the whip or the brake, nor speak or indicate the course to the Athlete. (See Article C945.2)

### 3. Cones

#### 3.1 The Course

- a) The dressage arena or an adjacent arena may be used.
- b) The number of cones used will be at the discretion of the organizer, based on a suitable course flow in the space available.
- c) One multiple obstacle may be used.
- d) The starting line may not be less than 5 meters from the first cones. The finishing line may not be less than 5 meters from the last cones.
- e) There is no set distance between cones, but the design of the course should enable Athletes to maintain an even pace throughout the majority of the course.
- f) The course shall be open for inspection by the Athletes and trainers at an announced time prior to the start of the competition. .
- g) A course plan (Article C973.6.2) is not required, providing a map with speed, distance and allowed time is posted prior to the course inspection.
- h) When cantering on course is NOT allowed (as stated in the prize list), the penalty is 5 seconds per occurrence.

#### 3.2 Cones may be set as follows:

- a) Using the following clearance for each division and reset between competitors:

	<i>Horses and Ponies</i>	<i>VSE</i>
<i>Training division</i>	<i>35 cm + track width *</i>	<i>30 cm. + track width *</i>
<i>Preliminary division</i>	<i>30 cm. + track width *</i>	<i>25 cm. + track width *</i>
<i>Intermediate division</i>	<i>25 cm. + track width *</i>	<i>20 cm. + track width *</i>
<i>Advanced division</i>	<i>20 cm + track width *</i>	<i>15 cm + track width *</i>

\* Increase settings by 10cm for tandems, unicorns and four-in-hands.

- b) At the discretion of the organizer, Training division may use one setting for all competitors. The setting will be based upon the largest track width vehicle entered plus 35 cm.
- c) At the discretion of the organizer, Preliminary division may use one setting for all competitors. The setting will be based upon the largest track width vehicle entered plus 30 cm.
- d) At the discretion of the Organizer, Cone pairs may be numbered with red and white markers placed on the cones themselves in lieu of Markers as required under Articles C973.5. One of the numbers should be rotated so the Athlete can see it from the previous obstacle whenever possible.
- e) When individual cone pairs are numbered as in (d) above, Article C973.5.5 will not apply. The entry is considered to have passed through the obstacle when any part of the carriage passes between the cones.

3.3 Grooms may not give verbal or physical direction nor may they lift or slide the vehicle during obstacle/cones competition.

#### 4. Scoring

Article C971 – *Summary of Cones Penalties* shall be used. Whenever “no cantering” is imposed, a penalty of 5 seconds shall be assessed for intentional breaks per occurrence.

#### 5. Marathon Obstacles

##### 5.1 Course

- a) The dressage/cones arena or an adjacent arena may be used.
- b) There shall be four marathon-type obstacles. Not more than two will be constructed at one time. The course shall be open for 10 minutes for inspection by Athletes and grooms before the start of the competition.
- c) One common entry/exit gate, 3 meters wide shall be placed in the center of the arena.
- d) Obstacles 1 and 2 shall be driven by the Athletes in all classes, then the obstacles may be re-lettered and known as Obstacles 3 and 4, or the first course driven again.
- e) Obstacles may have any number of dislodgeable elements.
- f) Before starting each obstacle, the judge will signal with a whistle or bell. Timing will start as the nose of the horse crosses the entry gate or 60 seconds after the signal, whichever occurs first. Timing will stop when the nose of the horse crosses the exit gate.
- g) If any part of an obstacle in advance of the one being driven is dislodged or knocked down, the President of the Ground Jury will ring the bell and stop the clock for the obstacle to be rebuilt. The Athlete will incur penalties for any knockdown elements, and 10 seconds will be added to his time. The clock will restart when the Athlete is approximately 10 m. from the rebuilt obstacle. Should this occur on the way to gate A, a total restart of the obstacle with the added penalties would be appropriate with any knockdown penalties and added ten seconds, as the start line would be considered 10 m. Away.

##### 5.2 Marathon Penalties

- a) Time in the obstacles shall be converted to penalty points at .25 points per commenced second..... 0.25 penalty
- b) Each element dislodged ..... 5 penalty points
- c) Putting down a whip in the obstacle .....5 penalties
- d) Correcting a course in an obstacle .....20 penalties
- e) Failing to correct a course in an obstacle .....elimination
- f) Groom off the carriage (both feet) in an obstacle .....10 penalties
- g) Athlete off the carriage in an obstacle .....30 penalties
- h) Overturned vehicle in an obstacle .....60 penalties (includes c, f and g above).
- i) Disconnecting and leading through an obstacle .....elimination
- j) Exceeding the time limit in an obstacle (3 minutes) .....elimination
- k) Failing to pass through entry or exit flags .....elimination
- l) Intentionally cantering when not allowed .....5 seconds/occurrence

## **APPENDIX 9-C – DRIVING DERBY (SUMMER AND WINTER)**

### **Chapter 1 – General**

1. Definition  
A Driving Derby competition consists of one or more rounds over a course consisting of pairs of cones and marathon-type obstacles as described below.
2. Rounds
  - 2.1 A round is run as a timed competition with penalties converted to seconds. Total time determines placings and the lowest time wins.
  - 2.2 The times plus penalty scores for multiple rounds are added to produce final scores and placings.
  - 2.3 If there is a change in the course route/design between Rounds, a minimum of a 15-minute course walk is allowed. If the change in course between rounds is only a change in track width, an additional course walk is not required.
  - 2.4 Ties will be broken by the fewest penalty points, a drive-off, or may remain at management discretion.
  - 2.5 An equine may compete no more than three rounds in a single day.
3. Starting Order
  - 3.1 The starting order of the first round is determined by the Organizing Committee (OC) or by random selection.
  - 3.2 If using multiple rounds, the starting order of subsequent rounds may be held in reverse order of the placings of the previous round(s). The order could also be determined by the Organizing Committee or by random selection.
4. Officials  
One licensed CD-judge or CD-TD for up to 24 entries. Derbies over 25 entries also require a licensed CD-TD or a second CD-judge. Officials may not officiate and compete at the same event.
5. Eligibility
  - 5.1 Competition is open to equines and Athletes in all Divisions (Training, Preliminary, Intermediate, Advanced).
  - 5.2 Classes may consist of VSE, Small Pony, Large Pony, & Horse turned out as singles, pairs, tandems, unicorns, and four-in-hands. Classes may be combined at Organizer's discretion.
6. Turnout  
Additional restrictions or variations may be made at the discretion of the OC.
  - 6.1 Carriage: Marathon-type carriage with iron or solid-rubber tires for Summer and standard Derby Sleigh for Winter are encouraged. There are no required weights or track widths. Width of marathon carriage is a minimum of 125 cm and for Winter, minimum width of the sleigh is 137 cm and minimum length of the skids are 122 cm.
  - 6.2 Harness: Bridle must have noseband. No type of check or auxiliary reins is allowed. Bits cannot be connected to lines by clips or snaps. Breeching is required for all single turnouts and for any vehicle without brakes.
  - 6.3 Safety: All Athletes and groom(s) must wear securely fastened protective headgear which meets ASTM/SEI standards for equestrian use. Safety (Protective) vests are strongly recommended.
  - 6.4 Groom(s):



- a) Singles, pairs and tandems: One groom required at all times except single VSE and single Small Pony.
  - b) Unicorns and four-in-hands: Two grooms at all times except VSE, which is only required one groom.
- 6.5 Whips:
- a) Whips must be of suitable length to reach the shoulder of the farthest horse and be carried at all times by the driver while the carriage is in motion.
  - b) If the whip is dropped, the driver or groom can retrieve a spare whip or the carriage must be stopped so a groom may dismount and retrieve the whip. In the case of drivers without a groom, the whip can be restored to the driver by an outside party. The penalty is the time lost.
  - c) Excessive use of the whip anywhere anytime will result in disqualification of the Athlete from the event.

## **Chapter 2 – The Competition**

### **7. Course**

#### **7.1 The course consists of:**

- a) common Start/Finish markers
- b) a minimum of two and a maximum of four marathon-type obstacles with up to five compulsory gates each
- c) 6-16 cones-type compulsory gates.
- d) There must be a minimum of two cones-type compulsory gates between each marathon obstacle and between the start/finish gates and a marathon obstacle.

7.2 Each obstacle is numbered numerically, with gates in marathon obstacles noted by a letter (e.g., 3A, 3B, 3C).

7.3 The size of the driving arena will be determined by the OC

7.4 The number of knockdowns on marathon-type obstacles is unlimited and at the discretion of an official.

7.5 The course will be open for inspection prior to competition. The exact time will be determined

7.6 When the course is ready, the official will signal the Athlete. Starting before the signal will result in a ten-second penalty and restart.

7.7 Timing will start as the nose of the horse crosses the start gate and stop when the nose crosses the finish gate.

7.8 Failing to pass through start or finish gates will result in elimination.

7.9 The start and finish lines are neutralized for passing through from the moment the Athlete has passed through the start line until he has passed through the last obstacle.

### **8. Compulsory Gates**

8.1 Compulsory Gates are marked with red and white numbers/letters and are to be driven in the correct direction and sequence. There are no entrance or exit gates for marathon-type obstacles. In a marathon-type obstacle, each lettered gate becomes individually open once it has been driven.

#### **8.2 Width of gates:**

- a) the common Start/Finish markers should be a minimum of 3 meters
- b) the marathon-type gates should be a minimum of 3 meters
- c) the cones-type gates can be set at either:

- i. 175 cm for all classes except for four-in-hands which may be set at 200 cm, or
    - ii. Use Standardized Cones settings as per 973.1.8.
  - d) d. If multiple rounds decrease the widths for each round, the organizer must state width reduction of each round in the Omnibus listing
- 8.3 On numbered cones gates, the obstacle can only be driven once, in the proper direction, in numerical order, and numbered cones gates remain "live." Passing through a compulsory lettered gate in a marathon-type obstacle out of order or in the wrong direction is elimination unless corrected. In order to correct, the Athlete must drive through the compulsory lettered gate missed before continuing in the correct sequence. Corrected course incurs 20-second penalty.
- 8.4 Gates in marathon obstacles:
  - a) Training: 3 gates
  - b) Preliminary: 4 gates
  - c) Intermediate: 5 gates
  - d) Advanced: 6 gates
- 9. Specifications
  - 9.1 Dislodging an element of the course will incur penalties, even if open.
  - 9.2 All balls or other dislodgeable elements which are knocked down remain on the ground until the Athlete has finished the course, unless the Official has rung the bell and the obstacle has to be rebuilt.
  - 9.3 Cones-type obstacles
    - a) Dislodging one ball of a single cones-type obstacle incurs a 5-second penalty. An additional 5-second penalty is given if the second ball is dislodged later by whatever means.
    - b) If any part of an obstacle in advance of the one being driven is significantly dislodged\* or knocked down, the official will ring the bell and stop the clock for the obstacle to be rebuilt. The Athlete will incur a 5-second penalty for each knocked down element, and an additional 5 seconds for each will be added to the time for rebuilding. The clock will restart when the Athlete reaches the next obstacle to be driven.
  - 9.4 Marathon-type obstacles
    - a) For each knocked-down element a 5-second penalty will apply.
    - b) If any part of a marathon-type obstacle is significantly dislodged\* while the Athlete is in the obstacle, and the Athlete cannot continue his course, the official rings the bell immediately and stops the clock. After the obstacle is rebuilt the official will ring the bell to signal the start. The Athlete must drive the obstacle starting at Gate A. The clock will start when the Athlete passes Gate A. For each knocked down element a 5-second penalty will apply, and for rebuilding, each time, an additional 5-second penalty is added.
  - 9.5 \*Significantly dislodging
    - a) Means that an element of an obstacle is moved or knocked over in a way that the Athlete has no possibility to continue his course through the lettered gates, or the obligatory gate is clearly changed in position and original width. The official will ring the bell and stop the clock for the obstacle to be rebuilt. If not

significantly dislodged, the official does not ring the bell and the Athlete has to continue the course.

- b) Each time an element must be rebuilt, an additional 5-second penalty is added.

#### 9.6 Disobedience

It is a disobedience when an Athlete attempts to pass through an obstacle and the horse(s) shy away from the obstacle at the last minute without hitting any part of the obstacle.

- a) Penalties for disobediences:
  - First or second disobedience, no penalties.
  - Third disobedience is elimination.
- b) If, in the opinion of the official(s) the Athlete has lost effective control of the horse(s) it is grounds for immediate elimination.

#### 9.7 Dismounting

- a) Intentional dismounting for safety reasons must occur while the carriage is at a halt. If the carriage is not at a complete stop the penalty is 10 seconds.
  - i) Groom(s) or Athlete intentionally dismounting, first and second time results in lost time. Clock does not stop.
  - ii) Groom(s) or Athlete dismounting intentionally for the third time is elimination.
  - iii) Failure to dismount and repair broken harness will result in elimination.
- b) Unintentional dismounting is any loss of Athlete or groom from the carriage while it is in motion.
  - i) Groom unintentional dismount: The carriage must be stopped, and the groom must remount the carriage prior to going through the next numbered gate or finish. There is no penalty except time lost. If the carriage does not stop the penalty is elimination.
  - ii) Driver unintentional dismount: Elimination
- c) All grooms must be on the carriage when the carriage passes the finish. Failure will result in elimination.

9.8 If groom(s) use the reins, whip or brake, except when vehicle is stationary, a 20-second penalty is incurred.

9.9 Carriage overturn. If the carriage overturns, the penalty is elimination.

9.10 Athletes competing in the Training division may not canter anywhere on the course. Cantering for more than 3 seconds at the Training division will result in 20 penalty seconds per occurrence.

## 10. Summary of Penalties

<b>DESCRIPTION</b>	<b>REF.</b>	<b>PENALTY</b>
Excessive use of the whip	6.5	Disqualification
Starting before the signal	7.3	10 seconds
Failing to pass through start or finish gates	7.4	Elimination
Numbered cones obstacle driven backwards, out of order, or more than once	8.3	Elimination
Corrected course, lettered gates	8.3	20 seconds
Wrong course, not corrected	8.3	Elimination
A dislodged element is knocked down by any means	9.3, 9.4	5 seconds
Causing an obstacle to be rebuilt (clock stops)	9.5	5 seconds
First or second disobedience	9.6	No penalties; time lost
Third disobedience	9.6	Elimination
Loss of effective control	9.6	Elimination
Groom not on carriage when passing Finish Line	9.7	Elimination
Dismounting while carriage is in motion	9.7(a)	10 seconds
Groom(s) or Athlete intentionally dismounting, first or second time	9.7	No penalties; time lost
Groom(s) or Athlete intentionally dismounting for third time	9.7	Elimination
Failure to dismount to repair broken harness	9.7	Elimination
Groom(s) or Athlete intentionally dismounting and remounting before next numbered gate or finish	9.7	No penalties; time lost
Groom(s) or Athlete intentionally dismounting and remounting after next numbered gate or finish or carriage does not halt for remount	9.7	Elimination
Driver unintentional dismount	9.7	Elimination
Groom uses the reins, whip or the brake	9.8	20 seconds
Carriage turnover	9.9	Elimination
Cantering in Training division per occurrence	9.10	20 seconds

11. Typical Course Design

The number of elements on the course shall be determined by the size of the arena available, not to exceed 4 lettered obstacles, one bridge, and 10 pairs of cones.

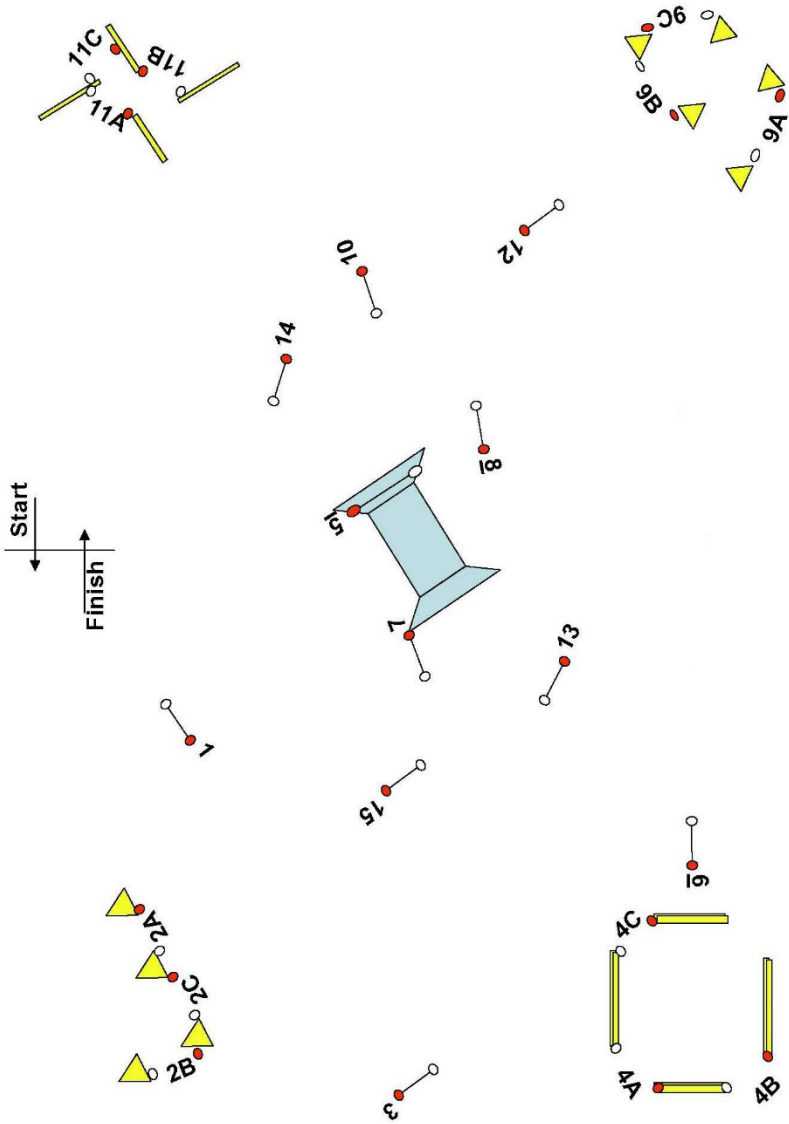

## APPENDIX 9-D – MEASUREMENT OF PONIES

Refer to Section A, Chapter 11 - *Measurement* for additional information.

1. An Equestrian Canada Measurement Card will be presented at the First Veterinary Inspection. If a pony is not in possession of a fully and correctly completed Measurement Card, the Ground Jury may order the pony to be remeasured by the Technical Delegate and the Competition Veterinarian and/or a Judge, pursuant to Chapter 11. Failure to allow the pony to be remeasured will result in the pony being disqualified at the competition. The remeasurement must be reported to the Ground Jury, who, if it is over height, must then either allow the entry in a horse class or disqualify the pony from the Competition. (See Article C930.2)
2. Ponies without Measurement Cards will be measured before the First Horse Inspection at their first competition of the year and issued with a Permanent Measurement Card (Article A1103) or a Temporary Measurement Form (Article A1104). For ponies eight years or older with passports, the Record of Measurement on the back page of the EC passport is to be completed. This constitutes the Permanent Measurement Card.
3. Measurement will be conducted by official EC licensed: Steward or Technical Delegate and the Competition Veterinarian and/or a Judge.
4. Measurement will be required yearly until the pony has reached the age of eight years. Animals under eight years of age will be issued an annual Temporary Measurement Form annually. Refer to Article A1104.
5. If an animal possesses an FEI or USEF Certificate of Measurement, such Certificates will be accepted as proof of the pony's height.
6. Refer to Article A1112 – Protesting Height or Article A1115 – Appeal of Height Measurement if required.

## APPENDIX 9-E – CDE QUICK REFERENCE GUIDE

This table provides a quick reference between divisions for Combined Driving Events. In case of discrepancy, the Rule in the reference Article shall prevail. See also Event Summary Table, Appendix 1-A for membership, licensing, and requirements for officials. Qualifications for each division are listed in Article C987.

	TRAINING	PRELIMINARY				
VEHICLE: Articles C937-9	No standard weight or track width in Dressage and Cones, see Article C937.3. For Marathon, see Article C937.4					
	Spares required. (Article C938)					
	Pneumatic tires allowed – no bicycle type wire spokes (Article C939)			Pneumatic tires allowed – no bicycle type wire spokes (Article C939)		
	Reflectors required unless exempted in prize list by Organizer (article C938); lamps not required. . (Article C938.2)					
HARNESS: Article C940	Side checks allowed (see Article C940.5)			No type of check reins allowed. (Article C940.5)		
PRESENTATION: Article C938, C955.6	Judged as separate competition at the halt. Spares required. Reflectors requirement Article C938.2.					
DRIVEN DRESSAGE: Articles C949-C956	ADS and AT Dressage Tests may be called (Article C952.2).			ADS or AT Tests must be driven from memory. (Article C952)		
MARATHON SECTIONS: Article C960.1.5	3 sections; A, Walk, B. Approximately 1 km. per obstacle required in Section B, preferably not less than 700m apart.					
MARATHON DISTANCE: Article C960.2	Distance up to 12 km. total			Distance 8 – 14 km. total		
	VSE may compete on a shortened course – C960.2.9					
MARATHON MARKERS (CTF and k-markers) Article 960.4 & .5	Diamond – white or black background			Square – green background		
	VSE – octagonal – orange or purple background, together with division Compulsory Turn Flag and k-markers if offered as a separate course					
SPEEDS (Max.) (kmph) Article C960 Horses:> 148 cm unshod Pony:Large.>137-148cm Med....>120cm to 137cm Small... 99 cm to 120 cm VSE...under 99 cm.	<b>Sec. A</b>	<b>Walk Sec.</b>	<b>Sec. B</b>	<b>Sec. A</b>	<b>Walk Sec.</b>	<b>Sec. B</b>
	14	6	13	14	6	14
	13	5	12	13	5	13
	12	5	11	12	5	12
	10	4.5	10	11	4.5	11
	9	3.5	9	10	4	9.5
PACE – Article C960.2.8, C960.6	Section A – any pace; Walk Section – walk; Section B – walk or trot only in sections*					
	Walk or trot only in Obstacles			Any pace in obstacles		
	*Walk or trot only from last obstacle or last 300m. to end of Section B (Article C960.6)					

	TRAINING	PRELIMINARY	
PEOPLE ON VEHICLE: Articles: C912, C943.2.9, C943.2.12	Navigator/groom required for Marathon. No passengers. Age limitations - Article C912. Grooms optional in Dressage and Cones for single turnout turnouts and in Marathon for single turnouts <120 cm. One groom always required for pairs and tandems; two grooms for unicorns and four-in-hands at all times. VSE single – optional VSE pair, tandem, four-in-hand; one required at all times.		
MARATHON OBSTACLES:  Article: C961	Max: Obstacle = 5; Gates = 3 per obstacle. Easy routes. Time <u>not</u> recorded.	Max: Obstacle 6; Gates = 4 per obstacle. Easy alternative route.	
	No gates on significant slopes. (Article C961.4.5)		
MARATHON TERRAIN Article C961.5.1	No Compulsory Turning Flags on significant slopes. Alternate easy route to be provided.		
MARATHON TIMES: based on time allowed (Ta). Article C963.2	<b>Sections</b> A Walk B	<b>Minimum Time</b> Ta – 2 min. none Ta – 3 min.	<b>Time Limit</b> 20% plus Ta 2 x Ta 2 x Ta
MARATHON TIMING: Articles: C963.2.4, C965.7, C967.3	Obstacles times <u>not</u> recorded. Time taken for 5 minute Time Limit only.		Obstacles timed to hundredths of a second.(C965.7.4)
Cones: Articles: C973, C975, C978 <i>S=Single; P=Pair;</i> <i>T=Tandem; 4=Four-in-hand</i> Horse / pony VSE	Maximum speed (mpm)	Minimum clearance (cm.)	Maximum speed (mpm)
	Minimum clearance (cm.)	Maximum speed (mpm)	Minimum clearance (cm.)
	<u>S-P</u> <u>T-4</u>	<u>S-P</u> <u>T-4</u>	<u>S-P</u> <u>T-4</u>
	180   170	35   45	200   190
	160   150	30   40	180   170
			<u>S-P</u> <u>T-4</u>
			30   40
			25   35
COMPETITION C: Obstacles: Articles C976.4	No bridge. Water permitted with an alternate land route		
	20 cm. maximum water depth for VSE classes (Article C973.4.6)		
	See Article C973.1 for standardized Cones settings when elected by the Organizer and published in the Prize List		



## APPENDIX 9-E – CDE QUICK REFERENCE GUIDE

This table provides a quick reference between divisions for Combined Driving Events. In case of discrepancy, the Rule in the reference Article shall prevail. See also Event Summary Table, Appendix 1-A for membership, licensing, and requirements for officials. Qualifications for each division are listed in Article C987. For Intermediate II information, use Advanced for Dressage and Cones, and Intermediate for Marathon.

	INTERMEDIATE			ADVANCED		
VEHICLE: Article C937, C939	No standard weight or track width in Dressage and Cones (Article C937.3). Marathon refer to Article C937.4			Weights – Article C947.4.1 Track width: Dressage and Cones minimums– Article C937.3; Marathon minimum Article C937.4		
	Spares at Athlete’s discretion (Article C938)					
	Pneumatic tires allowed – no bicycle type wire spokes (Article C939.2)					
	Reflectors required unless exempt in prize list by Organizer (Article C938); lamps not required. See Article C938.2			Reflectors required (Dressage only) (Article C938); lamps requirements (Article C938)		
Farrier: Article C960.3.4	Either on site or on call			Must be at Rest Area		
HARNESS: Article: C940	No type of check or auxiliary reins allowed. (C940.5)					
PRESENTATION: Articles: C938, C955.6	Judged on the move during Dressage. Spares optional. Reflectors requirements (Article C938.1).					
	Lamps optional in Dressage and Cones			Lamps and reflectors required in Dressage only.		
DRIVEN DRESSAGE: Articles: C949-C956	ADS or AT Tests to be driven from memory (Article C952).					
MARATHON SECTIONS Article C960.1.5	3 sections; A, Walk, B.			2 sections A, B or 3 sections A, Transfer, B		
	Approximately 1 km per obstacle required in Section B preferably not less than 700m apart.					
MARATHON DISTANCE: Article C960.2	Total distance 10.8 - 15 km. (C960.2.7c)			Total distance 11.8 – 17 km (C960.2.3)		
	VSE may compete on a shortened course (C960.2.9)					
MARATHON MARKERS (CTF and k-markers) Article C960.4 & .5	Circle – red background			Triangle – blue background		
	VSE –hexagonal – Orange background together with division markers if a separate course					
SPEEDS (Max.) (kph) Article C960 Horses:> 148 cm unshod* Lg/Med Ponies.>120-148cm*	<b>Sec. A</b>	<b>Walk Sec.</b>	<b>Sec. B</b>	<b>Sec. A</b>	<b>Walk Sec.</b>	<b>Sec. B</b>
	15	6.5	14	15	7	14
	14	5.5	13	14	6	13
	13	5.5	12	13	5.5	12
	10	4.5	10	11	4.5	10

Sm ponies 99cm -  
120cm  
VSE...under 99 cm

--	--	--	--	--	--

\*Measurements unshod. Add 1 cm if shod.

Note: Measurements for VSE, Small Pony and Medium Pony are shod/unshod.

	INTERMEDIATE	ADVANCED		
PACE –Articles C960.2.8, PACE: Articles C960.2.8, C960.6	Section A – any pace Walk Section – walk Section B – any pace *			
	* Walk or trot only from last obstacle or last 300m. to end of Section B ( C960.6)			
PEOPLE ON VEHICLE: Articles: C912, C943.2.9, C943.2.12	Groom – Singles optional in Dressage and Cones		Groom – Singles required in Dressage and Cones	
	Navigator/groom required for Marathon; optional for single turnouts <120cm. No passengers. Age limitations - Article C912. Turnouts. One groom required for pairs and tandems; two grooms for unicorns and four-in-hands at all times. VSE pair, tandem, unicorn, four-in-hand; one required at all times.			
MARATHON OBSTACLES:  Article: C961	Min. Obstacles = 6 Max: Obstacles = 7 Max. Gates = 5 per Obstacle Routes may be minimum width (2.5m); 2.0 m for VSE		Min. Obstacles = 6 Max: Obstacles = 8 Max. Gates = 6 per Obstacle	
MARATHON TERRAIN Article C961.5	Compulsory Turning Flags may be on moderate slopes.			
MARATHON TIMES: based on time allowed (Ta). Article C963.2	<b>Sections</b> A Walk B	<b>Minimum Time</b> Ta minus 2 min. none Ta minus 3 min.	<b>Time Limit</b> 20% plus Ta twice Ta twice Ta	
MARATHON TIMING: Article C965.7	Obstacles timed to hundreds of a second.			
CONES: Articles: C973, C975, C978 <i>S=Single; P=Pair; T=Tandem; 4=Four-in-hand</i> Horse / pony..... VSE..... <i>Intermediate II: See table C975.9.5</i>	Maximum speed (mpm)		Minimum clearance (cm.)	
	<i>S-P</i> 220	<i>T-4</i> 210	<i>S-P</i> 25	<i>T-4</i> 35
190	180	20	30	
CONES: Obstacles: Articles C973, C974	20 cm. maximum water for VSE classes (C973.4.6)		N/A	
	See Article C973.1.8 for standardized Cones settings when elected by the Organizer and published in the Prize List			

## APPENDIX 9-F – VSE SIZE-ADJUSTED ARENA DIAGRAMS

		Tests : Any current ADS or Arena Dressage tests		
		Test requirement	40m x 80 m	40m x 100m
Driven Dressage (Article C950.2)	VSE size-adjusted arena	20m x 40m or 30m x 60m	20m x 50m or 30m x 75m	
	Competition arena dimensions must be published in Prize List. Driven figures shall be reduced in proportion to the size-adjusted arena used.			
Marathon	Distances and Sections may be shortened for Training, Preliminary and Intermediate divisions.			
Cones	Size-adjusted arenas (Article C972.1.2, 972.1.3) and courses may be offered see Article C972.1.5			
	Training	Preliminary	Intermediate	Intermediate II
	Clearance: see Articles C973.1.6 (variable) or Article C973.1.8 (standard setting)			See Article C974.1
	Speeds: see Article C975.9.5			

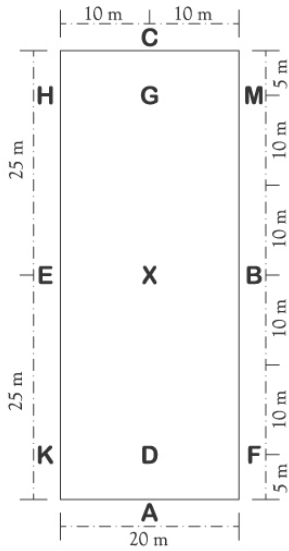

50 x 20 Meter Arena

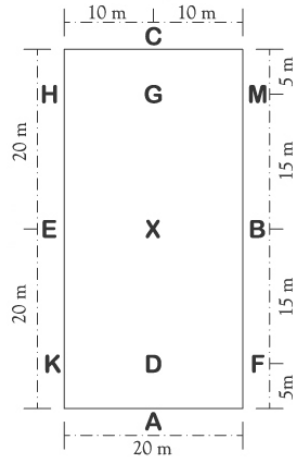

40 x 20 Meter Arena

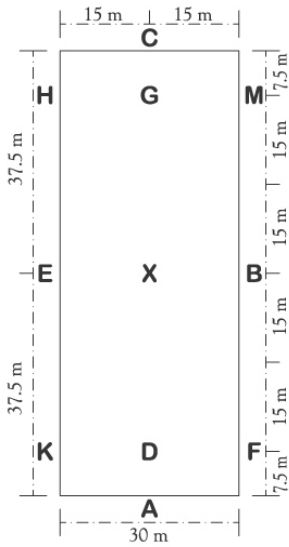

75 x 30 Meter Arena

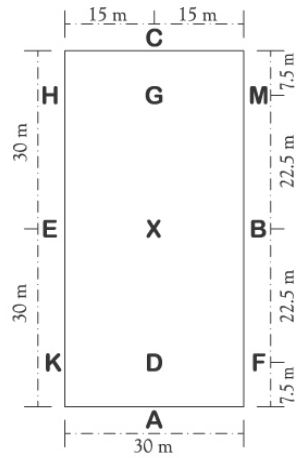

60 x 30 Meter Arena

# APPENDIX 9-G – ARENA DRIVEN DRESSAGE TEST

## Training Division

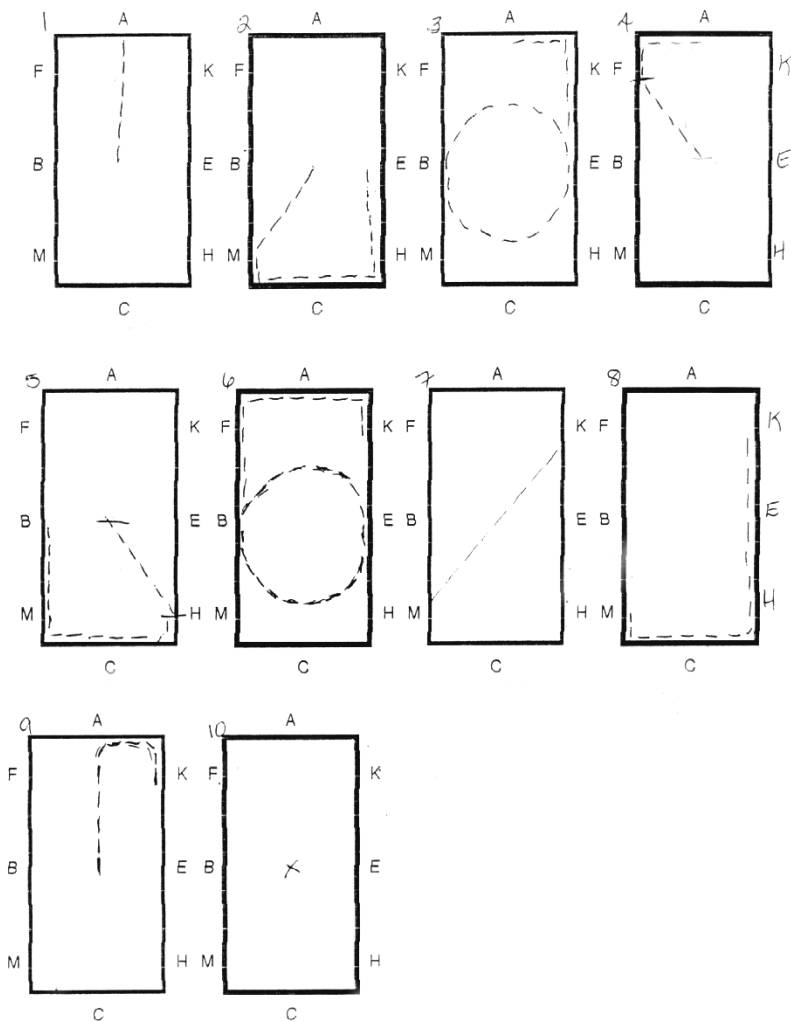

Training Division Arena Dressage

Element		Test	Directive	M	Comments
1	A	Working trot	Straightness on center line. Quality of halt, obedience, balance	10	
	X	Halt, salute			
2	XM	Develop a Working trot	Transition. Quality of trot and turn at M	10	
	M	Track left			
	MC	Working trot			
3	E	Circle left width of arena	Quality of trot and figure Consistent rhythm & suppleness	10	
	EA	Working trot			
4	AF	Working walk	Balance in transition & quality of walk Length of frame and stride. Relaxation, rhythm	10 x2	
	FX	Free Walk			
	X	Working walk			
5	Bet.	Develop working trot	Quality of transition and trot	10	
	XH H – B	Continue			
6	B	Circle right width of arena	Quality of trot and figure Consistent rhythm & suppleness	10	
	BAK	Working trot			
7	KXM	Change rein across diagonal	Quality of trot and turns, straightness and rhythm	10	
8	MCH-EK	Working trot	Quality of trot and balance in turn	10	
9	KAX	Working walk	Quality of walk, relaxation, rhythm	10	
10	X	Halt, salute	Quality of halt, obedience and balance	10	
Gaits		Freedom and regularity. If pair, maintaining an even pace and equality of work.		10 x 2	
Impulsion		Desire to move forward. Elasticity of steps. Relaxation of back. Engagement of hind quarters		10 x 2	
Submission		Acceptance of bit. Correctness of lateral bend. Attention and confidence. Calmness, lightness and ease of movements		10 x 2	
Athlete		Use of aids, handling of reins, whip and voice. Athlete's position.		10 x 2	

Total points = 190. Factor .789. less 150 + errors = score

## APPENDIX 9-H – ARENA DRIVEN DRESSAGE TEST

### Preliminary Division

Element		Test	Directive		Comments
1	AKX X	Enter working trot Halt, salute	Straightness . Quality of halt, obedience, balance	10	
2	XM M MC	Develop a Working trot Track left Working trot	Transition. Quality of trot and turn at M	10	
3	C A	Serpentine of 2 loops	Quality of trot and figure, suppleness rhythm	10	
4	AK KX XM	Working walk Lengthened walk Working walk	Balance in trans, lengthening of frame & stride, elasticity	10 x2	
5	Bet. MC CH	Develop working trot Working trot	Quality of transition and trot	10	
6	HXF  FA	Lengthened trot  Working trot	Straightness & balance of transition Lengthening of frame & stride, consistent rhythm	10	
7	A C	Serpentine of 2 loops	Quality of trot and figure, suppleness rhythm	10	
8	C A	Working trot	Quality of trot and balance in turns	10	
9	AFXG	Working trot	Quality of trot and figure	10	
10	G	Halt 3-5 seconds	Quality of halt, obedience and balance	10	
11	G	Rein back 3-4 steps	Willingness & acceptance of aids, straightness	10	
12	G	Halt, salute	Quality of halt, balance & obedience	10	
Gaits		Freedom and regularity. If pair, maintenance of even pace and equality of work.		10 x 2	
Impulsion		Desire to move forward. Elasticity of steps. Relaxation of back. Engagement of hind quarters		10 x 2	
Submission		Acceptance of bit. Correctness of lateral bend. Attention and confidence. Calmness, lightness and ease of movements		10 x 2	



Athlete	Use of aids, handling of reins, whip and voice. Athlete's position.	10 x 2	
	Total points:	21 0	
	Factor:(x.714)	15 0	
	Penalties: 150 – Factor points	=	
	Errors:	+	
	Score:	=	

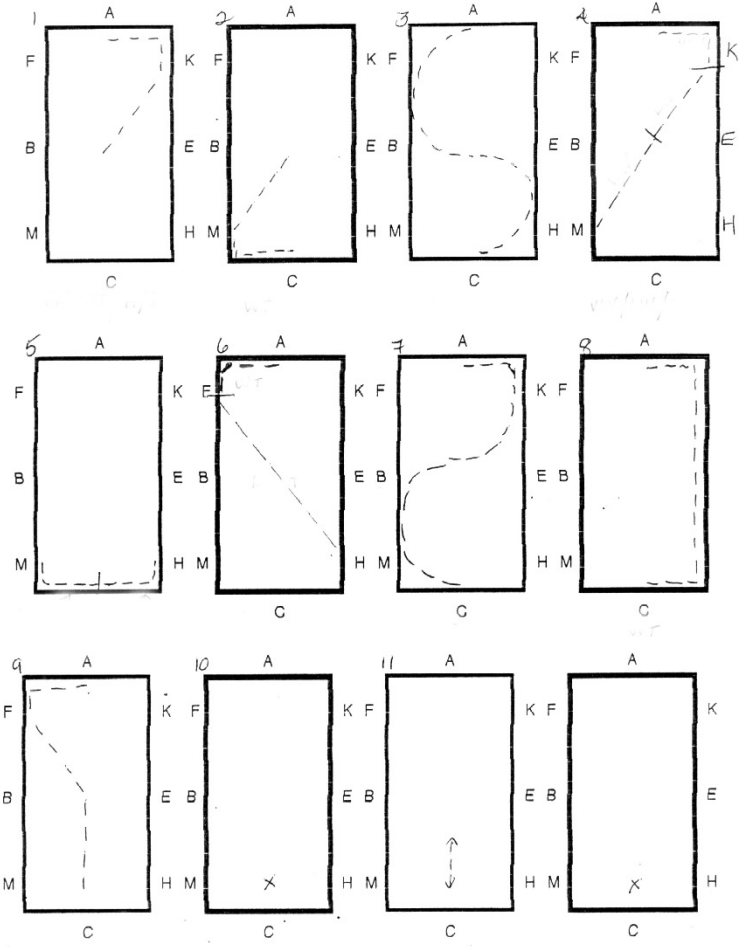



## **GLOSSARY**

### **AD**

Advanced

### **ADULT**

Individuals are adults from the beginning of the calendar year in which they reach the age of nineteen. For exceptions, see discipline/breed sport rules.

### **AFFILIATE ORGANIZATIONS**

Canadian equine or equestrian organizations with aims and objectives of national scope may apply to become affiliate members of EC. See Article A211, Affiliate Membership.

### **AGE OF A HORSE**

A horse is considered to be one year old on January 1 following the actual foaling date.

### **AGE OF A PARTICIPANT**

Except as modified by discipline/breed sport rules, a participant is considered to be a certain age until the end of the calendar year in which he or she turns that age. For example, riders remain Junior A until the end of the calendar year in which they turn 18.

### **AGENT**

Any adult or group of adults acting on behalf of an owner or lessee.

### **AM**

Amateur

### **AMATEUR**

For the purposes of these rules, an amateur is an adult Sport Licence holder who is eligible to compete in EC amateur classes as per EC regulations. See Article A902, Amateur Competitors, and specific discipline/breed sport rules.

### **APPEALS**

An appeal may be made against the decision of a competition organizing committee or against the decision of a hearing panel, provincial, territorial or national, regarding a protest or complaint. See Articles A1211 and A1212.

### **“B”**

Basic (Judge or Steward)

### **BOARD/BOARD OF DIRECTORS**

The Board of Directors of Equestrian Canada.

### **BORROWED HORSE**

A horse not owned by the rider competing in a Para-Equestrian Canada class.

### **CALENDAR YEAR**

The calendar year starts on January 1 and ends on December 31.

### **CANADIAN OLYMPIC COMMITTEE (COC)**

The Canadian Olympic Committee, the governing body for all Olympic disciplines in Canada. EC is a member of the COC.

### **CANADIAN PARALYMPIC COMMITTEE (CPC)**

The Canadian Paralympic Committee (CPC) National Paralympic Committee for Canada and is a member of the International Paralympic Committee (IPC). Equestrian Canada is a member of the CPC.

### **CAP**

See “Competition Administration Policy”.

### **CARDED ATHLETES**

Carded Athletes refers to athletes who are approved for funding and are directly financially support by Sport Canada through the Athlete Assistance Program (AAP). AAP support is referred to as CARDING.

### **CATEGORY**

Refers to the eligibility of the athlete defined by age, amateur status, open, etc.

### **CDI**

Concours Dressage Internationale

### **CDN**

Canadian

### **CERTIFIED COACH**

Equestrian Coaches who have completed an evaluation and are certified by EC in partnership with the Coaching Association of Canada. The following designations are available: Instructor, Competition Coach, Competition Coach Specialist, High Performance 1.

### **CERTIFIED INSTRUCTOR**

Equestrian Instructors who have completed an evaluation and are certified by EC in partnership with the Coaching Association of Canada.

### **CET**

Canadian Equestrian Team

### **CHILDREN**

Juniors competing in classes designated as children’s classes. See discipline/breed sport rules for cross-entry restrictions.

### **CLASSES**

1. Amateur/Amateur-Owner Class. For adult riders/drivers who hold a valid Sport Licence and EC amateur card or, when competing in their own breed divisions or classes, a valid amateur card from their breed or discipline affiliate organization. Riders/drivers from other countries must have a valid amateur card from their national federation. In amateur-owner classes, riders/drivers or

members of their immediate family must own the horse. See also 13. Owner Classes

2. Canadian-Bred Class. A Canadian-bred class is limited to entries of horses bred and foaled in Canada.
3. EC Point Classes. Classes in which competitors accumulate points at EC competitions towards annual EC awards.
4. Family Class. A class for two or more members of a family.
5. Gentlemen's Class. A class for gentlemen which may be restricted to riders, drivers or handlers who are no longer eligible to compete as juniors, unless otherwise specified in discipline/breed sport rules.
6. Ladies' Class. Class for ladies which may be restricted to riders, drivers or handlers who are no longer eligible to compete as juniors, unless otherwise specified in discipline/breed sport rules.
7. Limit Class. Limit classes are for horses or competitors that have not won six first place ribbons at EC Gold competitions or at USEF competitions in the particular performance classes in which they are being shown excepting winnings in four-in-hands, tandems, teams, unicorns, and pairs, and winnings in combined driving, local, model and breeding classes, unless otherwise specified in discipline/breed sport rules. A limit entry is such from the closing date of entries.
8. Local Class. A class held at an EC-sanctioned competition, which is restricted by geographic area but which is run according to all other EC rules. Local classes are not eligible for national or regional championships nor shall they count towards EC awards. See EC Competition Administration Policy, Local and Miscellaneous/Additional Classes.
9. Maiden Class. A class open to horses or competitors that have not received one first place ribbon at EC Platinum, Gold or Silver competitions or USEF competitions in the particular performance classes in which they are shown. A maiden entry is such until the closing date of entries.
10. Miscellaneous Class. A class which meets the particular requirements of a competition and is beneficial to the area but does not conform to the specifications for any class or division included in these rules. Entries in these classes will not accumulate points towards EC awards. Such classes or divisions must be identified in the prize list as "not rated for EC awards".
11. Novice Class. A novice class is open to horses or competitors that have not won three first place ribbons at EC Platinum, Gold or Silver competitions or USEF competitions in the particular performance classes in which they are shown, unless otherwise specified in discipline/breed sport rules. A novice entry is such until the closing date of entries.
12. Open Class. A class that is open to all horses of any age or breed, irrespective of ribbons previously won, and in which there is no qualification for the rider or driver.
13. Owner Classes. Open to adult riders/drivers who are owners or members of the owner's immediate family. Leased horses are not eligible and multiple

ownership is not permitted unless all owners are members of the same immediate family and members of EC. See discipline/breed sport rules for specific restrictions.

14. Parent and Child Class. For a parent and child. The age of the child may be specified. To be judged as a Family or Pair class using specifications in the discipline/breed sport rules.
15. Restricted Class. A class in which entries are restricted or limited in any way (i.e. according to money or ribbons won, years of competition, age, etc.)

Note: Classes restricted by geographic area are Local Classes.

**CLASSIFIER** A Para Equestrian Classifier is an individual trained and qualified to administer athlete classification nationally and/or internationally.

### **CLASSIFICATION**

Classification is undertaken to ensure that an Athlete's impairment is relevant to performance on the horse. Classification aims to place athletes into classes or Grades according to how much their impairment impacts on the core determinants of success in the sport. Classification ensures the Competition within each Grade can then be judged on the functional skill of the rider regardless of impairment.

### **CLIENT**

Any person who pays a fee for equestrian and/or equine-related services.

### **COACH**

An adult who instructs and educates riders or drivers. See also CERTIFIED COACH

### **COC**

See "Canadian Olympic Committee".

### **COMPETITION**

1. For the purposes of these rules, the term competition includes all shows, events, horse trials and any other form of equestrian competition that is covered by these rules.
2. Platinum Competition. A term for a competition that is operating a Gold EC-sanctioned competition and an FEI sanctioned competition at the same time and venue.
3. Gold Competition. This category of competition formerly called a National Competition is subject to the rules set out in the Rules of Equestrian Canada. Points accumulated at EC Gold sanctioned competitions apply towards the EC awards programs.
4. Silver Competition. A category of competition sanctioned by Equestrian Canada, organized and named by the province subject to the rules set out in the Rule Book. Competitors in this category of competition are not eligible to accumulate points for annual EC championship awards. Provinces may establish their own awards program for these competitions.
5. Bronze Competition. A grass-roots category competition (similar to the former Primary Competition) sanctioned by EC and subject to the rules set out in the

Rules of Equestrian Canada, subject to discipline-specific restrictions. Competitors in this category of competition are not eligible to accumulate points for annual EC championship awards. Provinces may establish their own awards program for these competitions.

6. Sanctioned Competitions. Bronze, Silver, Gold and Platinum competitions are all sanctioned by Equestrian Canada and are subject to the rules set out in the Rules of Equestrian Canada.

### **COMPETITION ADMINISTRATION POLICY (CAP)**

This policy outlines the three-stage process for obtaining an EC-sanctioned competition sanction/licence, and the responsibilities of the competition organizing committee, the Participating Provincial or Territorial Sport Organization (PTSO) and Equestrian Canada regarding sanctioned competitions.

### **COMPETITION EMPLOYEES AND OFFICIALS**

All persons directly employed by the competition, and all individuals officiating at a competition including but not limited to judges, stewards, course designers, technical delegates, veterinarians, timekeepers, announcers and ringmasters.

See also Licensed Officials.

### **COMPETITION MANAGER**

A person designated to manage a competition (see Competition Administration Policy 5.1.2). This person must hold a valid EC Sport Licence at or above the level of the competition, and must be in good standing.

**COMPETITION ORGANIZING COMMITTEE OR MANAGEMENT** All persons who are responsible for all or part of the management and organization of a sanctioned competition including but not limited to members of a competition's Board of Directors, the officers, competition committee chairperson or president, manager and secretary.

### **COMPULSORY TURNING FLAG (CTF)**

*In driving*, a pair of markers used to define the required track of the Marathon course. Each CTF must be numbered consecutively within the section and placed so they are clearly visible to be passed with the red marker on the right and white on the left. Numbering shall be affixed to the right hand marker using the shapes and colours defined for each division (Article C960.5)

### **COMPETITION YEAR**

The competition year is the calendar year.

### **COMPETITOR**

The person entered in a competition as a rider, driver, vaulter or handler.

1. Rider – directs the movement of or controls the horse from a saddle.
2. Driver – directs the movement of or controls the horse from either the ground or on a vehicle using a lead, lunge or reins augmented by whip and voice as the primary aids.
3. Vaulter – performs gymnastic and dance exercises on the back of a moving horse. A vaulter is not a rider, as the horse's movement is directed and controlled by a lunger using a lunge line, a lunge whip, and static side reins.

4. Handler – directs and controls the movement of the horse other than as specified above.

### **COMPLAINT**

A formal submission in writing on the required form stipulated within the EC Discipline, Complaints and Appeal Policy setting out the details of an alleged complaint, violation, breach, or grievance.

### **CONFLICT OF INTEREST**

A substantial appearance of a conflict of interest exists whenever others may reasonably infer from the given circumstances that a conflict exists. A conflict of interest is defined as any personal, professional or financial relationship, including, but not limited to, relationships of family members that could influence or be perceived to influence objectivity when representing or conducting business or other dealings for, or on behalf of EC. For example, a person is considered to be in conflict of interest if that person or that person's family stands to benefit from a decision or from information obtained in the course of official duties and responsibilities which is not generally available to the membership or the public. See Chapter A14, Conflict of Interest Provisions.

### **CPC**

Canadian Pony Club

### **DISMOUNTING**

The deliberate departure of a person from the horse/carriage or the accidental leaving (falling off) of the horse/carriage .

### **DISQUALIFICATION**

Disciplinary action, prohibiting a competitor and/or entry from any further participation for the duration of a competition, and usually requiring the forfeiture of all winnings and the loss of entry fees.

### **DIVISION**

A grouping of entry based on competition criteria. Example: Training, Preliminary, Intermediate, Intermediate II, Advanced.

Blocks of FEI tests written by FEI and used by EC. Always prefaced by the abbreviation "FEI ...".

### **EC DRESSAGE COMMITTEE**

The National Committee responsible for the development of Dressage in Canada.

### **EC DRIVING COMMITTEE**

The National Committee responsible for the development of driving in Canada.

### **EC EVENTING COMMITTEE**

The National Committee responsible for the development of Eventing in Canada.



## **EC JUMPING COMMITTEE**

The National Committee responsible for the development of the hunter, jumper and equitation divisions of equestrian sport in Canada.

## **EC NATIONAL PASSPORT**

The EC national passport is for use in FEI CIM-level competitions within Canada by Canadian owned horses. Please note that Canadian owned horses competing outside of Canada will require an FEI Passport or FEI Recognition Card. Horses competing with the EC National Passport in FEI competitions must also have an annual FEI Registration. Horses competing in CI-level competitions or FEI competitions outside of Canada, must upgrade to an FEI Recognition Card.

## **EC PARA-DRESSAGE COMMITTEE**

The National Committee responsible for the development of Para-Dressage in Canada.

## **DRP**

Dispute Resolution Path/Process

## **DRR**

Dispute Resolution Request

## **EC**

Equestrian Canada

## **EC/USEF RECIPROCAL AGREEMENT**

An agreement between EC and USEF on the recognition and suspension of officials, amateur certification and jointly recognized competitions.

## **ELIMINATION**

Exclusion from any further participation in the class in which the elimination occurs.

## **ENTRY**

Horse or pony entered in competition, or, in equitation, horsemanship or reinsmanship classes, the rider or driver respectively.

## **ENTRIES**

1. Applications to compete in an EC-sanctioned competition, which must be signed by an individual who holds a valid EC Sport Licence or member of the national federation of another country, excepting parents or guardians signing an entry for a junior. See Chapter A9, Entries.
2. Late entry. An entry made and accepted after the closing date of entries and before the commencement date of the competition.
3. Post-entry. An entry made after the commencement of the competition or after the closing of entries, depending upon the rules of each competition.
4. Regular entry. An entry made before the closing date for regular entries.

## **EQUESTRIAN CANADA (EC)**

Equestrian Canada is the national governing body for all equine and equestrian sporting and recreational activities and interest (except racing) in Canada. If the name of EC changes at any time, any reference to EC will refer to its replacement name or organization.

## **EVENT**

The entirety of activities, classes, competitions or combinations thereof, commencing and concluding as defined by the Organizer in the Prize List and which is covered by these rules. Also see “Competition”.

## **EVENT LOCATION**

All lands used by the competitions comprising the event. The competition rings, arenas, warm-up areas, stabling, parking and all grounds available or used for an event or competition owned, leased or rented by the Organizing Committee for the purposes of holding an EC-sanctioned event.

## **EVENTING**

EC rules for the discipline of Eventing, formerly called Combined Training, cover Horse Trials, Two-Day Events and Three-Day Events.

## **FALLS**

Competitors are considered to have fallen when, either voluntarily or involuntarily, they are separated from their horse, which has not fallen, in such a way that they touch the ground or find it necessary, in order to get back into the saddle, to use some form of support or outside assistance.

1. A horse is considered to have fallen when at the same time both its shoulder and quarters have touched either the ground or the obstacle and the ground.
2. See also discipline/breed sport rules.

## **FEDERATION**

For the purposes of these rules, the “Federation” means Equestrian Canada or the replacement organization should its name change.

## **FÉDÉRATION EQUESTRE INTERNATIONALE (FEI)**

The Fédération Equestre Internationale is the international equestrian sport governing body, of which EC is a member.

## **FEES, NOMINATION AND START**

1. Nomination Fee. A fee, usually non-refundable, which is levied by the competitions and, in some cases, organizations sponsoring special competitions such as futurities, to establish eligibility and intent to enter classes or divisions or special events. The fee constitutes a part of the total entry fee and allows the competitor the option to compete, usually upon payment of an additional fee, in the classes or divisions or special events for which the nomination fee was paid.
2. Start Fee. An additional fee levied by the competition applied to previously nominated entries and paid before commencement of a class. Payment of the

fee allows the entries to compete in the class for which they have been nominated.

## **FEI**

See Fédération Equestre Internationale

## **FEI SCHEDULE**

An official document approved by the FEI outlining relevant information of an Event, including but not limited to the dates and location of the Event, the dates by which entries must be received, the Disciplines in which Competitions will be held, the programme of Competitions, the categories, nationalities and other relevant details of invited Athletes and Horses, the stabling and accommodation available, the value of the prizes and their distribution, and any other relevant details.

## **FEI 1\*2\*3\* 4\* 5\***

Categories of FEI sanctioned competition and certification classification of FEI Officials.

## **GATE**

*In driving:* A pair of lettered or unlettered markers used in an obstacle to define the route.

## **GENERAL PERFORMANCE DIVISION**

A multi-performance division open to all horses, with classes conducted according to the General Performance rules. See Section F, General Performance.

## **GOOD STANDING**

Participants in good standing are individuals who hold sport licences with Equestrian Canada who have paid their current licence dues, are not currently suspended and/or are not subject to any form of disciplinary action as described in these rules.

## **GP**

Grand Prix

## **GPS**

*In dressage;* Grand Prix Special

## **GPF**

*In dressage;* Grand Prix Freestyle

## **GROOM, ATTENDANT OR ASSISTANT**

A person who assists a competitor.

## **GUEST CARD**

A guest card is a temporary licence issued by EC for officials not listed in the current EC Officials Roster or not listed in the capacity or with the qualifications which the competition requires.

## **HAND**

A hand is a unit of measurement that may be used to determine the height of a horse or pony. A hand measures four inches. Equines may also be measured in centimetres.

## **HANDLER**

See “Competitor”.

## **HEADER**

*In driving:* A groom or passenger, who “heads” a horse in a lineup in a driving class.

## **HEADGEAR STANDARDS**

Protective headgear must be certified under one of the following standards: ASTM (American Society for Testing Materials)/SEI (Safety Equipment Institute, Inc.); BSI/BS EN (British Standards Institution); EN (European Union Standards); AS/NZS (Australian/New Zealand Standards); or CE VG1 01.040 2014-12 (provided they are BSI Kitemarked).

## **HORS CONCOURS**

Non-competitive entry, entered in a competition with the permission of the organizing committee. Not eligible for any winnings at that competition from the time it performs hors concours. See discipline/breed sport rules.

## **HORSE**

The term “horse” in this Rule Book, unless otherwise stated, denotes a horse, pony, mule, donkey, zebra or Very Small Equine (VSE). For competition purposes, a horse is over 14.2 hands high. For exceptions, see discipline/breed sport rules.

## **HORSE RECORDING**

A Horse Recording is a digital identification document for horses competing at EC Silver, Gold and Platinum competitions. The purpose of a Horse Recording is to enable EC to create a database profile for every horse competing at EC-sanctioned competitions. This allows EC to:

- Track the number of competitions, and classes per competition, that a horse is entered in to protect horse welfare.
- Record competition results to aid owners in the marketing and sale of horses, and to identify successful bloodlines.
- Assist in horse identification and safeguard against horse misrepresentation.
- Track eligibility of all horses and ponies, and record official pony measurements, to ensure fair play.
- Accurately track horses throughout their lifetime, regardless of ownership and/or horse name changes.

## **I1**

*In dressage:* abbreviation for the Intermediate 1 test

## **I2**

*In dressage:* abbreviation for the Intermediate 2 test

## **IMMEDIATE FAMILY / FAMILY**

The words “immediate family” and “family” include the following: husband, wife, spouse, common law, same- or opposite-gender partner, parent, child, step-child, brother, sister, half-brother and sister, step-brother and sister, in-laws of the same relation stated above, grand-parents and grand-children, unless otherwise stipulated in discipline/breed sport rules.

## **JR**

Junior

### **JUDGING PANEL**

Two or more judges on the ring at the same time

### **JUNIOR/YOUTH**

1. Except as modified by discipline/breed sport rules, individuals are juniors until the end of the calendar year in which they reach the age of 18.
2. Junior "A". Riders/drivers are classified as Junior "A" from the beginning of the calendar year in which they turn 16 until the end of the calendar year in which they turn 18.
3. Junior "B". Riders/drivers are classified as Junior "B" from the beginning of the calendar year in which they turn 13 until the end of the calendar year in which they turn 15.
4. Junior "C". Riders/drivers are classified as Junior "C" such until the end of the calendar year in which they turn 12.

In Western classes, individuals are youths until the end of the calendar year in which they turn 19. See also discipline/breed sport rules.

### **JURY**

For the purposes of these rules, a jury is deemed to be one judge or any number of judges as required by the class or event rules.

### **LAMENESS CATEGORIES**

**Grade I:** is defined as lameness difficult to observe. Not consistently apparent regardless of whether the horse is circling, going up or down a hill, trotting on a hard surface, etc.

**Grade II:** is defined as lameness difficult to observe at a walk or trot on a straight line.

**Grade III:** is defined as a consistently observable lameness at a trot.

**Grade IV:** is defined as an obvious lameness with marked nodding.

**Grade V:** is defined as minimal weight bearing on one leg, or inability to move.

*In endurance;* Grades III to V are automatically excused from BC judging; Grades I and II usually are not. The "soundness" score should reflect the significance of the gait impairment as well as the degree of impairment at that moment. A horse that merely has a peculiar way of going may appear slightly "off" so it is very important for the vet to have made notes, whether mental or otherwise, about how each horse moved at the pre-ride exam.

**LESSEE**

An individual or group of individuals leasing a horse; to be official the lease must be registered with EC.

**LEVEL**

Blocks of EC national dressage tests written by the USEF and used by EC. Refers to Training through Fourth Level and all Freestyles.

**"M"**

Medium (Judge or Steward)

**MEMBER**

Members of Equestrian Canada, including Category A, Category B and Category C members; see Equestrian Canada Bylaws, Article 3 – Membership. The term “member” may also be used in these rules to refer to a member of an organization such as FEI / USEF. See also Registered Participant

**NATIONAL CHAMPIONSHIPS**

Any national competition may apply for National Championships through the EC National Office and pay the required fees.

**NATIONAL FEDERATION (NF)**

The national sport governing body of a country, which is a member of the FEI.

**NATIONAL OFFICE (EC)**

The administrative office of EC.

**NATIONAL ORGANIZATION**

A Canadian equine or equestrian society or organization, which has objectives and aims with Canadian scope, is registered in Canada, has a Canadian head office and a Canadian Board of Directors.

**NF**

See National Federation

**O**

Open

**OFFICIALS**

Officials, including judges, stewards, course designers and technical delegates, who are recognized and certified by Equestrian Canada to officiate at EC-sanctioned competitions.

**PARTICIPANT**

Any person involved with, competing in, taking part in, in any capacity with regards to the said event. Said “event” is not restricted to competition and could include but is not limited to clinics, shows, competitions, demonstrations and training sessions. See also Registered Participant.

## **PARTICIPATING PTSO**

A Provincial or Territorial Sport Organization that has a current Affiliation Agreement with Equestrian Canada to provide various services and products and represents the aims and objectives of the national federation in its region.

## **PERSON(S) RESPONSIBLE**

The Person(s) responsible (PR) for a horse must be an adult who has, or shares responsibility for the care, training, custody, and performance of the horse and who has official responsibility for that horse under EC Rules. The PR is liable under the penalty provisions of the applicable EC Rules for any rule violations.

Every entry form for an EC sanctioned competition must identify the PR and be signed by the PR.

The Person(s) responsible is ultimately responsible for the condition, fitness and management of the horse and is alone responsible for any act performed by himself/herself or by any other person with authorized access to the horse in the stables, elsewhere on the grounds, or while the horse is being ridden, driven or exercised.

**A:** For adult entries into EC sanctioned competitions the PR shall be either the trainer, the owner of the horse or the competitor who rides or drives the horse during the EC sanctioned competition.

**B:** For Junior entries into EC sanctioned competitions the Junior competitor cannot be the PR. For Junior entries the PR may be either the trainer, the owner of the horse, or a parent/guardian of the Junior competitor.

## **PONY**

1. Ponies are animals that do not exceed 14.2 hands, unless otherwise specified in discipline/breed sport rules.
2. "A" ponies exceed 13.2 hands but do not exceed 14.2 hands
3. "B" ponies exceed 12.2 hands but do not exceed 13.2 hands
4. "C" ponies do not exceed 12.2 hands

## **PRIZE LIST**

Required for all EC-sanctioned competitions. A publication which serves as an invitation to compete and provides all information required by the officials and the competitors in the competition. See Chapter A6, Prize Lists and Entry Forms.

## **PROTECTIVE HEADGEAR**

1. Protective headgear must be:
  - a) approved by an accredited certification organization (HEADGEAR STANDARDS).
  - b) properly fitted; and
  - c) securely fastened by a permanently affixed safety harness.
2. Any competitor may wear approved protective headgear in any division or class without penalty from the judge.
3. Equestrian Canada makes no representation or warranty, expressed or implied, about any approved protective headgear. Equestrian Canada cautions riders

and Athletes that serious injury or death may result despite wearing such headgear, as all equestrian sports involve inherent risk, and no protective headgear can protect against all foreseeable injury.

### **PROTECTIVE VEST (BACK PROTECTORS)**

1. Protective vest must be:
  - a) properly fitted; and
  - b) securely fastened.
2. Any competitor may wear a protective vest in any division or class without penalty from the judge.
3. Equestrian Canada makes no representation or warranty, expressed or implied, about any protective vest and does not imply protective vests may protect against all foreseeable injury.

### **PROTEST**

A formal process, expressed in writing, to the Competition Organizing Committee (OC) to lodge a dispute, disagreement or grievance regarding the conduct of the EC-sanctioned competition or an alleged rule or policy violation on the part of the OC or official(s) at an EC-sanctioned competition. See Article A1204 – Filing a Protest.

### **PROVINCE (PARTICIPATING PTSO)**

For the purposes of these rules, the term “Province” refers to the Provincial or Territorial Equestrian Sport Organization,

### **PSG**

*In dressage; Prix St. Georges*

### **PTSO**

Provincial/Territorial Sports Organization (provincial or territorial organization overseeing equestrian activities)

### **“R”**

Recorded (Judge)

### **RAPPING**

The term “rapping” is construed to include all of the artificial techniques intended to induce a horse to jump higher or more carefully in competition. It is not practical to list every possible means of rapping, but in general it consists of the competitor — and/or dismounted assistants, for whose behavior the competitor is responsible — either hitting the horse’s legs manually with something (no matter with what or by whom) or deliberately causing the horse to hit something itself, whether by building fences too large and/or too wide, setting false ground lines, placing trot poles or elements of a combination at a false distance, intentionally pushing the horse into a fence or otherwise making it difficult or impossible for the horse to negotiate the practice obstacle without hitting it.

### **REGISTERED LEASE**

A lease registered with EC or the FEI. See Article A817, Registered Leases.



## **REGISTERED PARTICIPANT**

Any Person registered with Equestrian Canada, including Sport Licence Holders, and paying dues to obtain some benefit from Equestrian Canada. Registered Participant status is included with a PTSO membership.

## **REMUNERATION**

For the purposes of these rules, remuneration is defined as any payment, either in cash or in kind, with the exception of gifts of token value.

1. Remuneration does NOT include:
  - a) payment made to any competition official
  - b) reimbursement for expenses without profit
  - c) winnings paid to a horse's owner

## **RULE BOOK/RULES**

“Rule Book” refers to the Rules of Equestrian Canada and all its parts. “Rules” refer to the rules and regulations of EC contained in the Rule Book.

## **“S”**

Senior (Judge or Steward)

## **SENIOR**

Individuals are adults or seniors from the beginning of the calendar year in which they reach the age of nineteen. For FEI rules visit [www.fei.org](http://www.fei.org)

## **SHOWN AND JUDGED**

To be “shown and judged” in a class, an animal must perform the prescribed routine and must remain in the ring until excused by the judge.

## **SOUNDNESS**

Must be serviceably sound. See also Unsoundness.

## **SPORT LICENCE**

EC Sport Licences are required by competitors, owners or lessees, and individuals/corporations accepting responsibility for entries in EC-sanctioned competitions.

## **START OF A COMPETITION**

The official start of a competition relates to the same day that officials are required to be on duty. For exceptions, see discipline/breed sport rules.

## **SUSPENSION**

Disciplinary action resulting in the suspension of a horse and/or owner, lessee, rider, driver, handler or any other responsible party from further participation in EC-sanctioned competition until the term of the suspension has expired.

## **TRAINER**

An adult who has the responsibility for the care, training, custody and performance of the horse.

## **TROPHY**

1. Challenge Trophy - A challenge trophy has to be won a specified number of times for outright possession.
2. Perpetual Trophy - A perpetual trophy remains in the possession of the winner for a period of 11 months, at the end of which time it is to be returned to the competition organizing committee. A replica may be given instead of a perpetual trophy.

## **TURNOUT**

*In driving*; The assemblage including the Athlete (Athlete), required groom(s), horse(s) with harness and carriage appropriate to the competition. Description includes configuration – single, pair, tandem, unicorn or four-in-hand. Examples: Horse single; pony pair; VSE unicorn; Small pony tandem

## **UNSOUNDNESS**

Unsoundness is:

- a) consistently observable at any gait under all circumstances;
- b) marked nodding, hitching or shortened stride; or
- c) minimal weight-bearing in motion and/or rest and inability to move.
- d) Any manifestation of pain, inability, disability or deformity in the act of motion is considered an unsoundness.

## **UNITED STATES EQUESTRIAN FEDERATION (USEF)**

The equestrian sport governing body of the United States.

## **USDF**

United States Dressage Federation

## **USEF**

United States Equestrian Federation

## **VALID SPORT LICENCE**

A Sport Licence is considered valid when it is current and the holder is in good standing.

## **VETERINARIAN**

Veterinarian: the veterinarian must be licensed to practice in the province/territory in which the competition is being held or in the home province/territory of the horse that is in competition and owner of or employed by a practice that is approved by its province/territory to participate in equine practice.

## **VIOLATION**

For the purpose of these rules, a violation is deemed to be any act prejudicial to the interests of EC. See Article A1207 – Violations.

**WINNINGS**

All ribbons, prizes, prize money, trophies and points won by a horse.

**YELLOW WARNING CARD**

An alternative to other options in the EC legal system, (eg. fines or disqualification) and is for cases of violations deemed to be minor in nature.

**YR**

Young Rider

**YOUNG RIDER/DRIVER**

Young riders/drivers are such from the beginning of the calendar year in which they reach the age of sixteen until the end of the calendar year in which they reach the age of 21.

**METRIC CONVERSION**

<u>WHEN YOU KNOW.....</u>	<u>MULTIPLY BY .....</u>	<u>TO FIND</u>
Hands .....	4 .....	inches
Inches .....	2.54 .....	Centimeters
Centimeters .....	0.3937 .....	Inches
Yards .....	0.9 .....	Meters
Meters .....	3.281 .....	Feet
Feet .....	0.3048 .....	Meters
Miles .....	1.609 .....	Kilometers
Kilometers .....	0.6214 .....	Miles
Pounds.....	0.4536 .....	Kilograms
Kilograms .....	2.205 .....	Pounds

## INDEX

Advertising		
Para-Driving .....	115	
Advisory Process .....	105	
Amendment of the Rules.....	v	
Appeals		
Judge's decisions.....	15	
Appointments.....	43	
Arena Driving Trial .....	228	
Arena Trial exceptions.....	228	
Artificial hair .....	10	
Assistance		
Para-Driving .....	117	
Attire.....	8, 9, 17, 53	
Formal or Park.....	53	
Gentlemen.....	8	
Ladies.....	8	
Passengers.....	20	
Passengers.....	18	
Sporting Vehicles .....	53	
Bandages and Brushing Boots .....	10	
Banned substances .....	112	
Bits.....	86	
Bridge diagram .....	216	
Canadian Addenda		
Para-Driving .....	110	
CATEGORIES		
PARA-DRIVING .....	110	
Championship points .....	24	
Championships .....	24	
Chief Steward		
Para-Driving .....	114	
Class		
Names .....	15	
Classes		
Coaching.....	49	
Combination .....	27	
Combination Hunter.....	28	
Concours d'elegance.....	29	
Continuous Driving Event .....	50	
Country Heritage .....	71	
Cross-country Obstacles .....	41	
Double Jeopardy.....	36	
Drive and Ride.....	28	
Fault and Out .....	39	
Fault Obstacle.....	42	
Freestyle.....	26	
Gambler's Choice.....	40	
Gentlemen to Drive.....	25	
Ladies to Drive .....	25	
Obstacle Driving		
Turnout .....	30	
Para-Driving .....	115	
Park .....	25	
Pick Your Route .....	37	
Picnic Class.....	30	
Pleasure Drive		
Timed.....	45, 46	
Turnout .....	44	
Progressive Obstacles.....	39	
Putting To .....	47	
Reinsmanship .....	26	
Reverse Psycholoty .....	37	
Scurry .....	36	
Sporting Tandem .....	28	
Timed Obstacles .....	36	
TREC .....	67	
Turnout.....	24	
Working .....	24	
Your Route/My Route.....	37	
Classification		
Horse size.....	9	
Para-Driving .....	119	
Classification and Scoring .....	85	
Classifiers		
Para-Driving .....	114	
Coaching		
Best team.....	49	
Classes.....	49	
General rules .....	49	
Obstacles.....	50	
Pleasure.....	49	
Time obstacles .....	50	
Turnout.....	49	
Code of Conduct		
Para-Driving .....	111	
Collars not tied together.....	11	
Collars of four-in-hand leaders.....	18	
Height .....	9	
Compensating Aids		
Para-Driving .....	117	
Competition		
Emergencies.....	6	
Height comparison table .....	10	
Competition Age.....	226, 228	

Competition Officials.....	94	Division of classes.....	16
Competition Standards		Divisions	
Para-Driving.....	115	Driver.....	23
Competitors		Experience.....	23
Para-Driving.....	116	Draft Driving	
Conduct.....	4	Dress.....	64
Cones		Class conditions.....	64
Alternate option cones.....	218	Horses.....	63
Course inspection.....	227, 229	Obstacle classes.....	64
Conflict of interest.....	4, 97, 101, 105	Turnout.....	63
Continuous Driving Event.....	50	Draft Equine rules.....	63
Country Heritage.....	71	Dress.....	8
Course		Draft Driving classes.....	64
Pleasure Drives.....	42	Drivers.....	8, 17
Course briefing		Grooms.....	8, 9, 17
Cones.....	227	Passengers.....	18
Course briefing		Pleasure Drives.....	42
Arena Trials.....	229	Dressage test	
Course Designer		Para-Driving.....	118
Duties.....	98, 102, 103	Dressage Test data.....	91
Para-Driving.....	114	Dressage Test No.4	
Pleasure Driving.....	98	Para-Driving.....	122
Course Designers.....	1, 94	Dressage Test scoring.....	92
Course walk.....	30	Driven Dressage	
Cruelty.....	4, 86	Arenas.....	90
Currier and Ives.....	74	Tests.....	91
Definition		Driven Dressage	
Gaits.....	22	Abbreviations.....	89
Definitions.....	1	Dress.....	80
Children.....	225	Figures.....	78
Competition.....	225	Half Halt.....	78
Dismounting.....	225	Halt.....	75
Entry.....	225	Management responsibilities.....	86
Horse.....	225	Movements	
<i>Junior</i> .....	225	Canter.....	77
Organizing Committee.....	225	Shoulder In.....	77, 78
Period of an Event.....	225	Stretching the Frame.....	78
Showgrounds.....	225	Object.....	75
Terminology.....	2	Rein back.....	77
Turnout.....	225	Scoring.....	83
Young Athlete.....	225	Submission.....	79
Disabilities.....	2	Tests.....	80
Dismounting.....	16, 20	Transitions.....	78
Disobedience		Trot.....	76
Refusal.....	34	Walk.....	76
Run-out.....	34	Driven Dressage	
Stopping.....	34	Arenas.....	243
Disputes.....	105	Driven Dressage	
Division		VSE Arenas.....	243
size.....	22	Drive-off.....	39

Driver.....	2	Required.....	19
Drivers.....	115	Standing on carriage.....	20
Driver's responsibilities.....	16	Ground Jury	
Driving Steward.....	103	Para-Driving .....	114
Driving Trial		Ground Observers	
Exceptions.....	226	Reporting .....	178
Drugs and medications .....	2	Guest Cards.....	104
Drugs and medicines .....	112	Halt .....	21
Drugs/medications .....	16	Harness	
Eligibility of horses.....	9	Badly fitting.....	5
Emergencies.....	6	Colour .....	11
Emergency Preparedness		Kicking straps.....	11
Plan.....	6	Para-Driving .....	117
Entries.....	15	Style .....	11
Pleasure Drives.....	43	High Point competitions	
Entry .....	2	Fault and Out .....	39
Adult .....	2	Gambler's Choice.....	40
Junior.....	2	Progressive.....	39
Equipment change .....	16	Hors Concours (H/C).....	31
Equipment for officials		Horse .....	2
Para-Driving .....	115	Horses	
Error of Course .....	82	Para-Driving .....	116
Error of Test.....	82	Indentification Waiver.....	107
Errors of course.....	123	Interpretation of the Rules .....	vi
Event Management.....	106	Invitations	
Event Secretary.....	107	Para-Driving .....	111
Evergreen Rules Process .....	v	Judge	
Exhausted horses .....	5	Combined Driving.....	99
Extraordinary Rule Amendment		Driven Dressage .....	99
(ERA) process .....	vi	Pleasure Driving .....	95
Fault competitions		<b>PRESENTATION</b> .....	109
Cross-country .....	41	Judges .....	94
Fault Obstacle.....	42	Judge's decisions .....	15
Filing reports .....	105	Jury of Appeal	
Flash nosebands .....	18	Para-Driving .....	114
Free Style Scoring Form.....	93	Kicking straps .....	11
Gaits		Ladies to Drive.....	25
Halt.....	21	Leading a turnout .....	20
Rein back .....	21	Leaving arena.....	20
Strong trot .....	21	Leaving the arena.....	19
Walk.....	20	Limit .....	23
Gate Attendants.....	108	Maiden.....	23
Gate hold.....	16	Management.....	2, 106
General Impression.....	85	Marathon	
GENERAL RULES		Bridge diagram .....	216
<b>PARA-DRIVING</b> .....	110	Measuring obstacles.....	32
Gentlemen to Drive .....	25	Metric conversion chart.....	265
Grade I drivers .....	115	Natural wood vehicle.....	18
Grade II drivers.....	115	Novice .....	23
Groom .....	2	Objective	
Grooms		Para-Driving .....	111

Obstacles	
Course.....	31
Course maps.....	31
Course widths.....	31
Measurement.....	32
Penalties.....	31
Timing.....	33
Officials	
Course Designers.....	1, 94
Driving Stewards.....	1, 103
Driving Trials.....	226
Judges.....	94
Non-licenced.....	106
Technical Delegates.....	94
OFFICIALS	
PARA-DRIVING.....	113
Officials required.....	
Organization of the Rulebook.....	v
Organizing Committee.....	106
Outside Assistance.....	8
Paddock Marshals.....	108
Para-Driving.....	110
Para-Equestrian	
Addendum.....	220
Park	
Class specifications.....	25
Gaits.....	25
Vehicles.....	25
Passengers required.....	19
Penalties.....	34
Double Jeopardy.....	37
Gambler's Choice.....	40
Progressive.....	39
Putting To competitions.....	49
Scurry.....	36
Time competitions.....	44
Your Route/My Route.....	38
Persons on carriage.....	19
Persons on Vehicle.....	9
Pleasure Drives	
Briefings.....	43
Course map.....	42
Course Observers.....	43
Course walk.....	42
Dress.....	42
General.....	42
Order of go.....	42
Rest stops.....	42
Timed.....	45, 46
Timing.....	43
Turnout.....	44
Vehicle repairs.....	42
Pony.....	2
Pony Measurement Card.....	237
Preamble	
Para-Driving.....	110
Presentation	
Para-Driving.....	118
Prize-giving ceremonies	
Para-Driving.....	119
Protective headgear.....	9
Protective Headgear.....	3, 19
Protective vests.....	3
Purpose of rules.....	1
Qualification for entry	
Para-Driving.....	112
Quick Reference Guide.....	238, 240
Recreation Competition	
Country Heritage.....	71
Rein back.....	21
Responsibility	
Competitors.....	5
Driver	
Harness.....	11
Pleasure Shows.....	16
Safety.....	5
Vehicle.....	11
Emergencies.....	6
Officials.....	5
Show Management.....	7
to Horses.....	6
Restricted vehicles.....	17
Ringmaster.....	108
Rule interpretation.....	vi
Rules of the road.....	6
Russet harness.....	18
Safety Inspectors.....	109
Salute	
Para-Driving.....	117
Sanctioning and approval	
Para-Driving.....	111
Scale of marks.....	123
Schooling	
Entries.....	31
Scorer.....	108
Scoring.....	83
Scurry.....	36
Second entries.....	30
Serpentine diagram.....	213
Show Secretary.....	107

Sleigh Rallies .....	74	Turnouts	
Spares .....	43	Four wheeled	
Specialty division		Surrey, Cabriolet .....	60
Contemporary vehicles .....	23	Four wheeled	
Marathon vehicles .....	23	Buggy .....	60
Traditional vehicles .....	23	Cart, Trap, Wagon.....	58
Splitting classes.....	16	Rockaway, Carryall, Depot	
Stable Livery .....	17	Wagon.....	60
Strong trot.....	21	Four-in-hand Breaks.....	57
Style of driving.....	7	Gigs .....	59
Substitution of drivers.....	112	Park Classes.....	53
Suggested Speeds.....	43	Park Drag.....	54
Sunglasses .....	3	Phaetons.....	57
Tail tying .....	10	Private Coach.....	54
Teams		Road Coach .....	55
Para-Driving .....	113	Runabout .....	60
Technical Advisor		Two wheeled cart	
Para-Driving .....	113	Road or jogging.....	60
Technical Delegate		Village or dog.....	59
Combined Driving.....	100	Use of Whip .....	8
Duties .....	96	Vehicle	
Para-Driving .....	113	Specialty division .....	23
Technical Delegates.....	94	Vehicle repairs .....	42
Technique de Randonnée Equestre de		Vehicle restrictions .....	17
Compétition .....	67	Vehicles.....	116
Ties .....	16, 34	American Stanhope.....	53
Time allowed .....	33	Breaks .....	53
Para-Driving .....	118	Bronson Wagon.....	53
Time allowed calculation .....	33	Cabriolet .....	53
Time competitions		Commercial .....	61
Double Jeopardy.....	36	Four-wheeled Dog Cart.....	53
Pick Your Route.....	37	Four-wheeled-Buggy .....	53
Reverse Psycholoty .....	37	Rockaway .....	53
Scurry .....	36	Runabout.....	53
Town and Country.....	36	Sailor Wagon .....	53
Your Route/My Route.....	37	Surrey .....	53
Time Competitions .....	36	Tandem Gig.....	53
Time limits .....	33	Traps.....	53
Timekeepers.....	108	Two Wheeled Dog Cart.....	53
Timing.....	33	Village Cart.....	53
Track widths		Veterinarians .....	108
Para-Driving .....	116	Veterinary inspection	
Transport Manager		Para-Driving .....	115
Para-Driving .....	115	Voice aids.....	16
TREC.....	67	Waiver .....	107
Turnout		Waiver of rules.....	8
Class.....	24	Walk .....	20
Driver, grooms, passengers.....	17	Wave diagram.....	215
Harness.....	18	Welfare of the horse.....	5, 86
Horses .....	10	Whip	
Livery.....	53	<b>Carried in hand</b> .....	18



Excessive use .....	5	Work offs.....	16
Salute .....	8	Year end awards .....	24
Use .....	8	Zig-zag diagram.....	214





**EQUESTRIAN  
CANADA  
ÉQUESTRE**

**EQUESTRIAN.CA**